



MOBOTIX

Quick Installation

MOBOTIX M73

© 2025 MOBOTIX AG



BeyondHumanVision

MOBOTIX

V8.17s, 3/26/2025, Order Code: Mx-M73

Table of Contents

| | |
|---|-----------|
| Table of Contents | 2 |
| Before You Start | 5 |
| Support | 6 |
| MOBOTIX Support | 6 |
| MOBOTIX eCampus | 6 |
| MOBOTIX Community | 6 |
| Safety Notes | 7 |
| Legal Notes | 7 |
| Notes on System Security | 9 |
| Drilling Template | 11 |
| Drilling Template PDF | 12 |
| Scope of Delivery | 13 |
| M73: Scope of Delivery | 14 |
| Connector Box RJ45: Scope of Delivery | 15 |
| Connector Box LSA: Scope of Delivery | 16 |
| Mounting Supplies: Scope of Delivery | 18 |
| Technical Specifications | 21 |
| Order Information | 22 |
| Hardware | 22 |
| Average Power Consumption | 24 |
| Image and Video Properties | 25 |
| General Software Features | 25 |
| Video Analysis | 27 |
| Video Management Software | 27 |
| Sensor Modules | 27 |
| Dimensions of Sensor Modules | 27 |
| Weight of Sensor Modules | 28 |
| Supported Image Sensor Modules | 28 |
| Supported Thermal Sensor Modules (Pre-mounted on Thermal Front Plate) | 29 |
| Features Thermal Image Sensors | 30 |
| Features ECO Thermal Image Sensor | 31 |

| | |
|--|-----------|
| Functional Modules | 32 |
| Connector Box LSA / Connector Box RJ45 | 33 |
| Dimensions | 35 |
| Mounting | 37 |
| Before Mounting the Camera | 38 |
| Protective Measures | 39 |
| Installing Sensor Modules | 40 |
| Opening the Module Housing | 45 |
| Installing the Security Clips | 47 |
| Closing the Module Housing | 48 |
| Installing a Thermal Front Plate | 50 |
| Removing the Security Clips | 51 |
| Removing Installed Sensor Modules | 52 |
| Installing the Sensor Modules to the Thermal Front Plate | 56 |
| Installing Security Screws | 59 |
| Mounting Options | 61 |
| Tiltability when mounted | 61 |
| Mounting to a Wall | 61 |
| Mounting to a Pole | 64 |
| Connecting the camera | 70 |
| Connecting the Camera to the Network | 70 |
| Terminal Connectors | 80 |
| Finishing the Installation of the Camera | 82 |
| Operating the Camera | 89 |
| Getting Started | 90 |
| LED states | 90 |
| Boot Options of the Camera | 91 |
| Network Settings | 93 |
| Windows | 94 |
| Mac | 95 |
| Linux / Unix | 95 |
| Network Settings on the Camera in the Webbrowser | 95 |
| Network Settings on the Camera in MxMC | 96 |

Table of Contents

| | |
|---|------------|
| Focusing the TELE 15° Sensor Module | 97 |
| Camera Software in the Browser | 101 |
| Access the Camera in the Web Browser | 102 |
| Basic Settings | 102 |
| Configuring Sensor Modules | 103 |
| Maintenance | 105 |
| Opening the Camera Body | 106 |
| Replacing the microSD card | 109 |
| Cleaning the Camera and Lenses | 110 |

Before You Start

This section contains the following information:

| | |
|---------------------------|----------|
| Support | 6 |
| Safety Notes | 7 |
| Legal Notes | 7 |

Support

MOBOTIX Support

If you need technical support, please contact your MOBOTIX dealer. If your dealer cannot help you, he will contact the support channel to get an answer for you as quickly as possible.

If you have internet access, you can open the MOBOTIX help desk to find additional information and software updates.

Please visit www.mobotix.com > [Support](#) > [Help Desk](#).



MOBOTIX eCampus

The MOBOTIX eCampus is a complete e-learning platform. It lets you decide when and where you want to view and process your training seminar content. Simply open the site in your browser and select the desired training seminar.

Please visit www.mobotix.com/ecampus-mobotix.



MOBOTIX Community

The MOBOTIX community is another valuable source of information. MOBOTIX staff and other users are sharing their information, and so can you.

Please visit community.mobotix.com.



Safety Notes

- This camera must be installed by qualified personnel and the installation should conform to all local codes.
- This product must not be used in locations exposed to the dangers of explosion.
- Do not use this product in a dusty environment.
- Protect this product from moisture or water entering the housing.
- Install this product as outlined in this document. A faulty installation can damage the product!
- Do not replace batteries of the camera. If a battery is replaced by an incorrect type, the battery can explode.
- This equipment is not suitable for use in locations where children are likely to be present.
- External power supplies must comply with the Limited Power Source (LPS) requirements and share the same power specifications with the camera.
- When using a power adapter, the power cord shall be connected to a socket-outlet with proper ground connection.
- To comply with the requirements of EN 50130-4 regarding the power supply of alarm systems for 24/7 operation, it is highly recommended to use an uninterruptible power supply (UPS) for backing up the power supply of this product.

Legal Notes

Legal Aspects of Video and Sound Recording

You must comply with all data protection regulations for video and sound monitoring when using MOBOTIX AG products. Depending on national laws and the installation location of the cameras, the recording of video and sound data may be subject to special documentation or it may be prohibited. All users of MOBOTIX products are therefore required to familiarize themselves with all applicable regulations and to comply with these laws. MOBOTIX AG is not liable for any illegal use of its products.

Declaration of Conformity

The products of MOBOTIX AG are certified according to the applicable regulations of the EC and other countries. You can find the declarations of conformity for the products of MOBOTIX AG on www.mobotix.com under **Support > Download Center > Marketing & Documentation > Certificates & Declarations of Conformity**.

RoHS Declaration

The products of MOBOTIX AG are in full compliance with European Unions Restrictions of the Use of Certain Hazardous Substances in Electrical and Electronic Equipment (RoHS Directive 2011/65/EC) as far as they are subject to these regulations (for the RoHS Declaration of MOBOTIX, please see www.mobotix.com, **Support > Download Center > Marketing & Documentation > Brochures & Guides > Certificates**).

Disposal

Electrical and electronic products contain many valuable materials. For this reason, we recommend that you dispose of MOBOTIX products at the end of their service life in accordance with all legal requirements and regulations (or deposit these products at a municipal collection center). MOBOTIX products must not be disposed of in household waste! If the product contains a battery, please dispose of the battery separately (the corresponding product manuals contain specific directions if the product contains a battery).

Disclaimer

MOBOTIX AG does not assume any responsibility for damages, which are the result of improper use or failure to comply to the manuals or the applicable rules and regulations. Our General Terms and Conditions apply. You can download the current version of the **General Terms and Conditions** from our website at www.mobotix.com by clicking on the corresponding link at the bottom of every page.

It is the User's responsibility to comply with all applicable local, state, national and foreign laws, rules, treaties and regulations in connection with the use of the Software and Product, including those related to data privacy, the Health Insurance Portability and Accountability Act of 1996 (HIPPA), international communications and the transmission of technical or personal data.

FCC Disclaimer

This equipment has been tested and found to comply with the limits for a Class A digital device, pursuant to part 15 of the FCC Rules. These limits are designed to provide reasonable protection against harmful interference when the equipment is operated in a commercial environment. This equipment generates, uses, and can radiate radio frequency energy and, if not installed and used in accordance with the instruction manual, may cause harmful interference to radio communications. Operation of this equipment in a residential area is likely to cause harmful interference in which case the user will be required to correct the interference at his own expense.

Notes on System Security

To protect the camera against security risks in data technology, the following measures are recommended after the installation has been completed:

MxManagementCenter:

- Menu **View > Wizards & Tools > Secure System:**
 - **Change camera factory default password:** ✓
 - **Enable encrypted HTTPS:** ✓
 - **Disable public access:** ✓
 - **User Management** (for all users):
 - **Force Complex Password:** ✓
 - **Log out on Inactivity:** After 5 min

User interface of the camera in the browser:

- **Admin Menu > Network Setup > Web Server:**
 - **Enable intrusion detection:** ✓
 - **Notification threshold:** 10
 - **Timeout:** 60 minutes
 - **Block IP Address:** ✓

For more information on this new feature, please read the «Cyber Protection Guide» on www.mobotix.com (under Support > Download Center > Documentation > Brochures & Guides > Cyber Security).

Drilling Template

Open this file in a PDF viewer (Acrobat Reader, Foxit Reader, or similar) and print the file **without scaling (original size)**.

NOTE! Download the drilling template from the MOBOTIX website: www.mobotix.com > [Support](#) > [Download Center](#) > [Marketing & Documentation](#) > [Drilling Templates](#).

CAUTION! Always print or copy the drilling template at 100% of the original size!

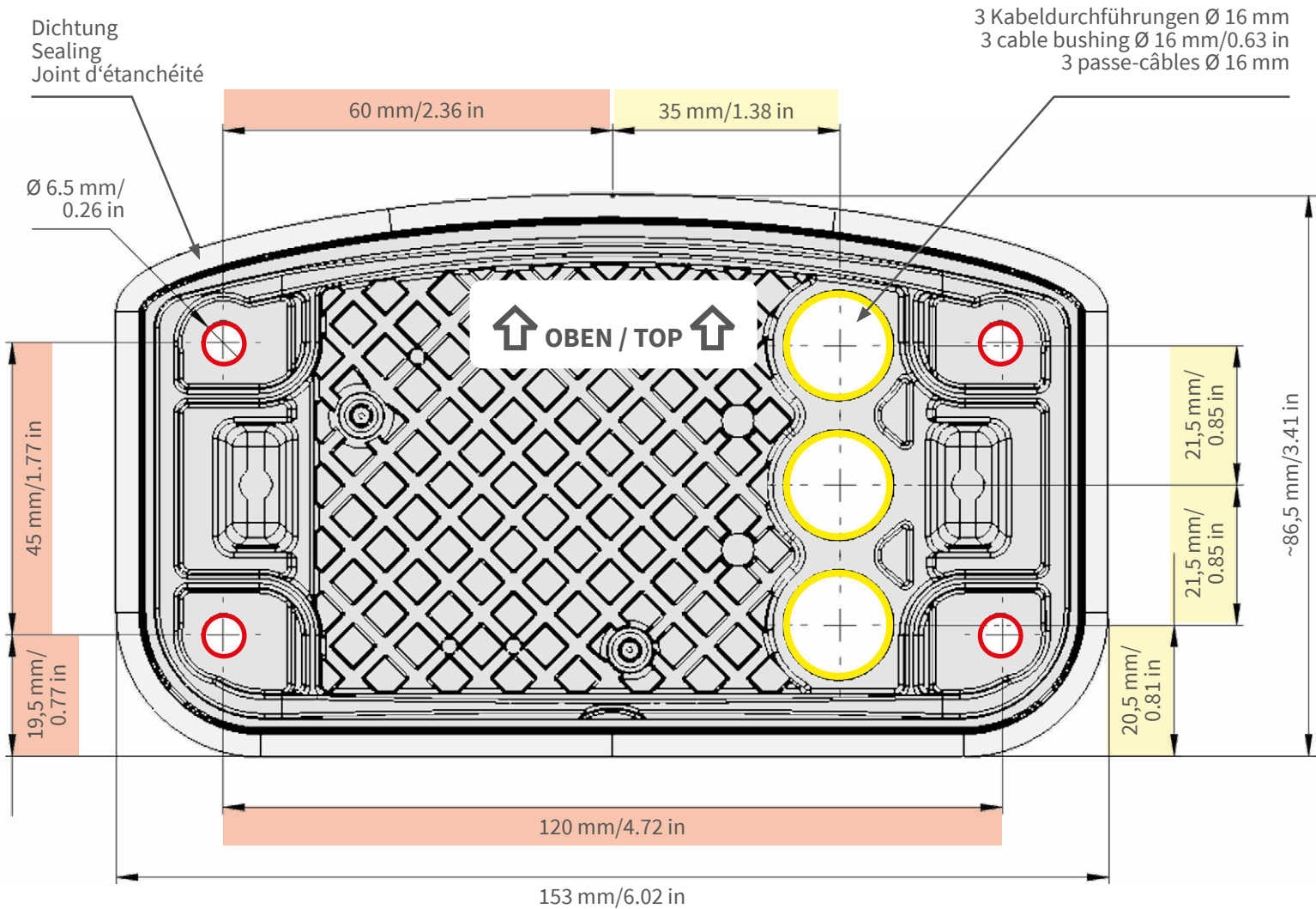

- Bohrungen für Befestigungsschrauben Ø 5 mm
- Holes for mounting screws 5 mm diameter
- Trous pour les vis de montage de 5 mm diamètre

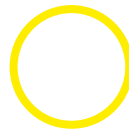

- Kabeldurchführungen Ø 16 mm
- Cable bushings 16 mm/0.63 in diameter
- Passe-câbles de 6 mm diamètre

Installation nur auf ebener Fläche! Unebenheiten dürfen 0,5 mm nicht überschreiten!

Installation only on level surface! Unevenness must not exceed 0.5 mm/0.02 in!

Montage uniquement sur une surface plane ! Les inégalités ne doivent pas dépasser 0,5 mm !



Nur in Originalgröße kopieren oder ausdrucken!

Always copy or print at 100% of original size!

Copier ou imprimer uniquement aux dimensions d'origine !

Scope of Delivery

This section contains the following information:

| | |
|--|-----------|
| M73: Scope of Delivery | 14 |
| Connector Box RJ45: Scope of Delivery | 15 |
| Connector Box LSA: Scope of Delivery | 16 |
| Mounting Supplies: Scope of Delivery | 18 |

M73: Scope of Delivery



Fig. 1: Scope of delivery MOBOTIX M73 Body

Scope of delivery M73 Body

| Item | Count | Description |
|------|-------|---|
| 1.1 | 1 | M73 Body with module housing, front plate and transport plugs, complete |
| 1.2 | 1 | Module housing |
| 1.3 | 1 | Front plate |
| 1.4 | 3 | Transport plug |
| 1.5 | 1 | Blind module (must be installed when using only two sensor modules) |

Scope of delivery M73 Body

| Item | Count | Description |
|------|-------|---|
| 1.6 | 1 | Mounting plate with wall sealing (installed), two standard plugs (installed), and inserted connector box. |
| 1.7 | 1 | MOBOTIX Ethernet patch cable, 50 cm/19.7 in with sealing |
| 1.8 | 1 | SD card 8 GB (installed) |
| 1.9 | 1 | Mounting supplies (see Scope of Delivery MOBOTIX M73 Mounting Supplies, p. 18) |
| 1.10 | 1 | Important Safety Information |

Connector Box RJ45: Scope of Delivery

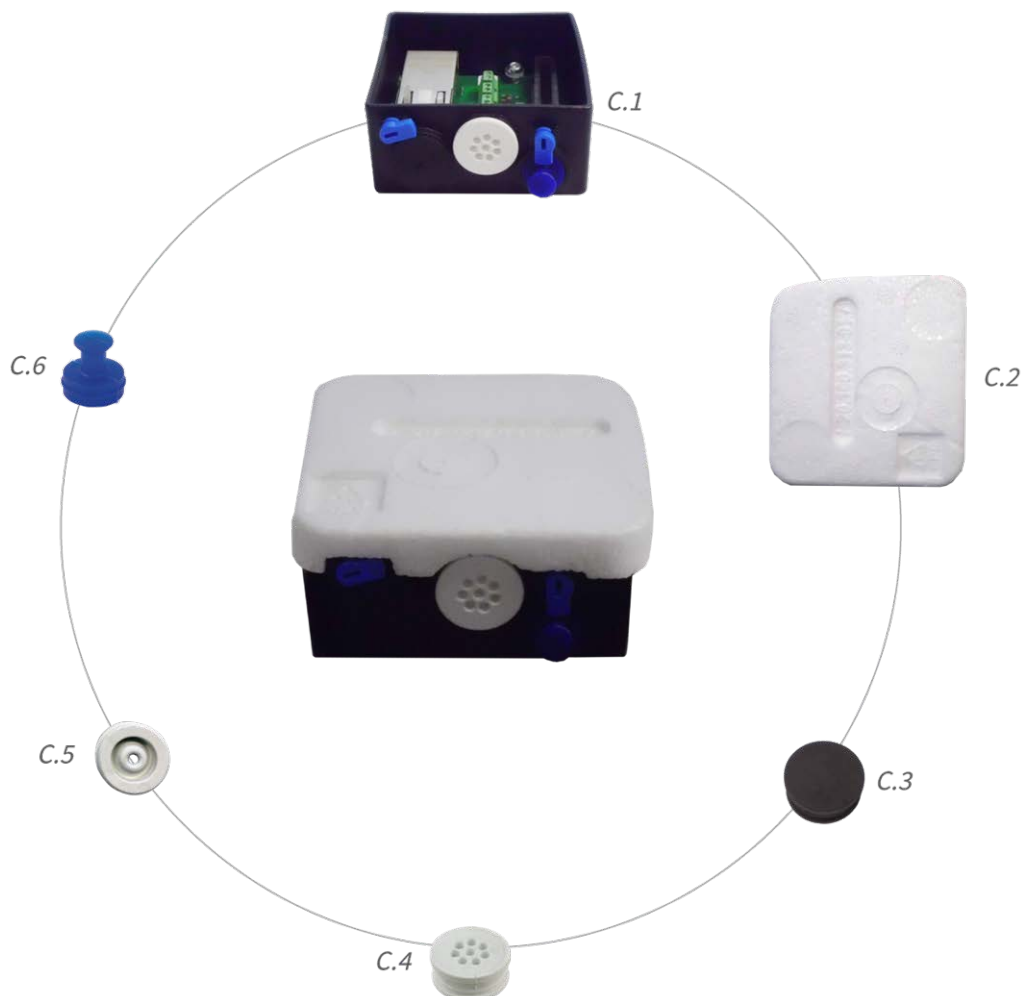

Scope of Delivery

Connector Box LSA: Scope of Delivery

Scope of Delivery M73 Connector Box RJ45

| Item | Count | Description |
|------|-------|---|
| C.1 | 1 | Connector box RJ45 black with rubber plug black, rubber plug single-wire white, USB plug blue (installed) |
| C.2 | 1 | Protective cover for connector box polystyrene white (installed) |
| C.3 | 1 | Rubber plug black (installed) |
| C.4 | 1 | Rubber plug single-wire white (installed) |
| C.5 | 1 | Rubber plug cable dia. 3.5 mm white (to replace C.5) |
| C.6 | 1 | USB plug connector box blue (installed) |

Connector Box LSA: Scope of Delivery

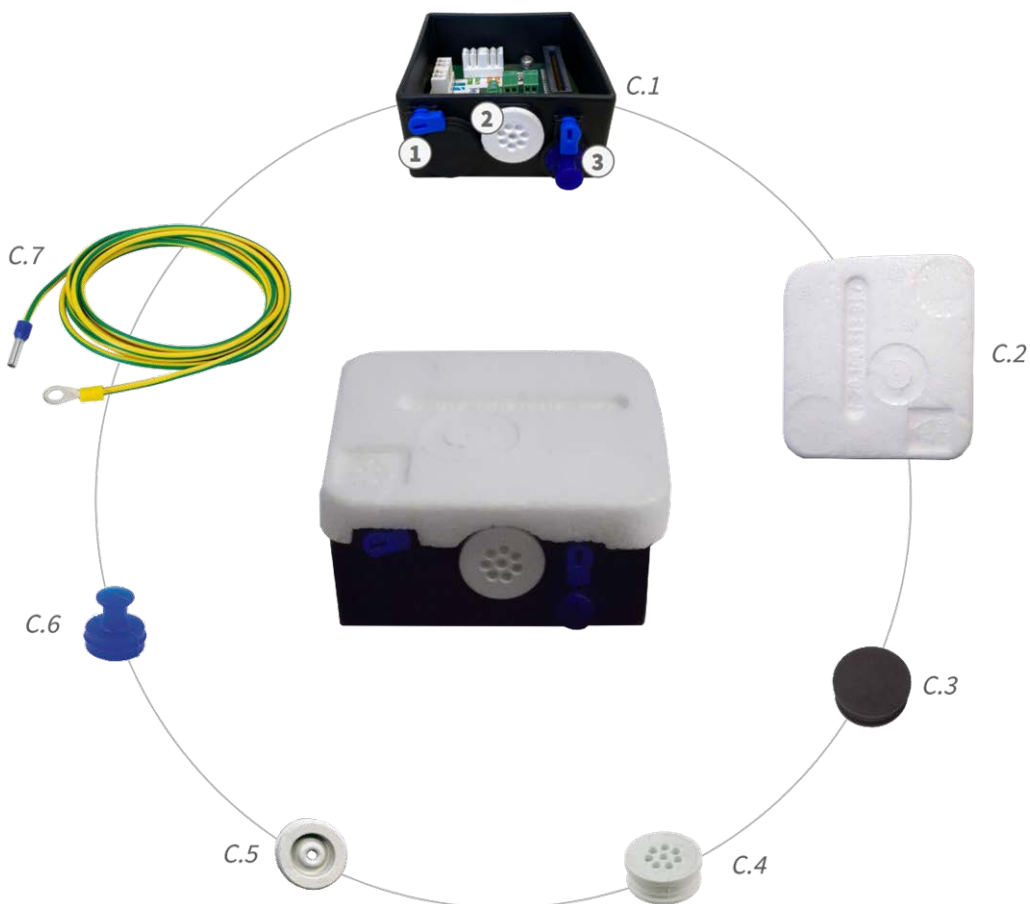

Fig. 2: Scope of Delivery MOBOTIX M73 Connector Box LSA

Scope of Delivery M73 Connector Box LSA

| Item | Count | Description |
|-------------|--------------|--|
| C.1 | 1 | Connector Box LSA black with rubber plug black, rubber plug single-wire white, USB plug blue (installed) |
| C.2 | 1 | Protective cover for connector box polystyrene white (installed) |
| C.3 | 1 | Rubber plug black (installed) |
| C.4 | 1 | Rubber plug single-wire white (installed) |
| C.5 | 1 | Rubber plug cable dia. 3.5 mm white (to replace C.5) |
| C.6 | 1 | USB plug connector box blue (installed) |
| C.7 | 1 | Ground wire (for overvoltage protection functionality) |

Mounting Supplies: Scope of Delivery

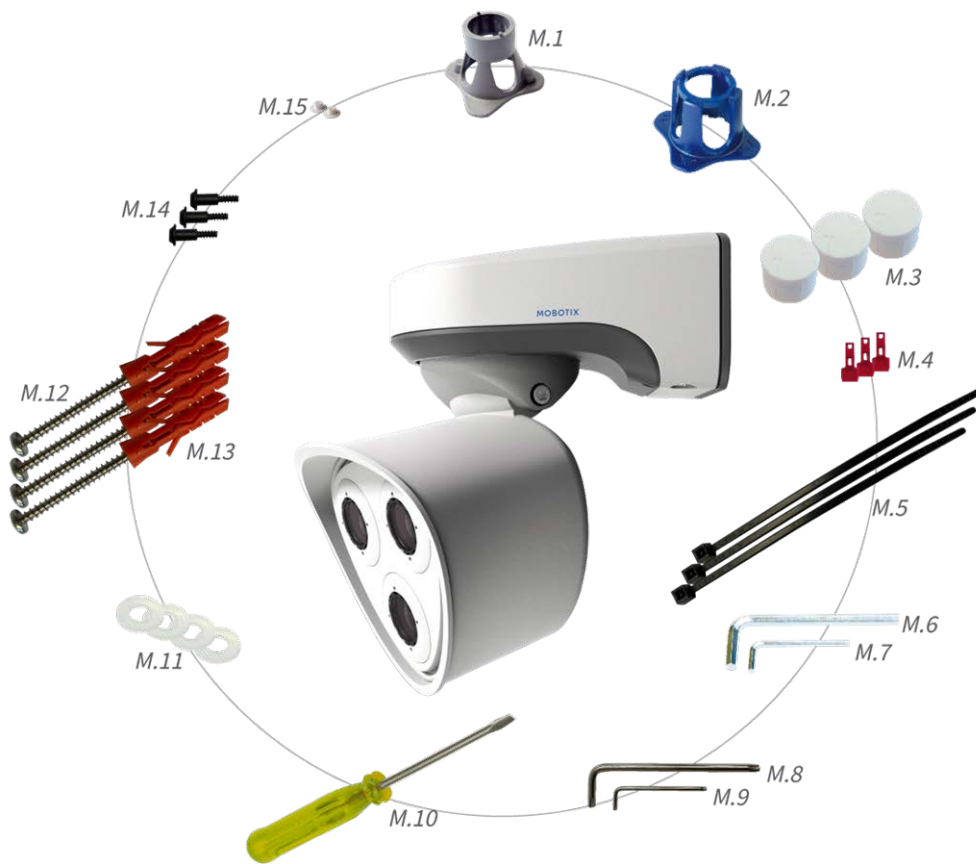

Fig. 3: Scope of Delivery MOBOTIX M73 Mounting Supplies

Scope of Delivery M73 Mounting Supplies

| Item | Count | Description |
|------|-------|-----------------------------|
| M.1 | 1 | Module wrench (gray) |
| M.2 | 1 | Lens wrench blue |
| M.3 | 3 | Housing plug silicone white |
| M.4 | 3 | Security clips plastic red |
| M.5 | 2 | Cable tie black |
| M.6 | 1 | Allen wrench 5 mm |
| M.7 | 1 | Allen wrench 2.5 mm |
| M.8 | 1 | TORX wrench TX20 |
| M.9 | 1 | TORX wrench TX10 |
| M.10 | 1 | Screwdriver yellow |

Scope of Delivery M73 Mounting Supplies

| Item | Count | Description |
|-------------|--------------|---|
| M.11 | 4 | Washer dia. 6.4 mm plastic white |
| M.12 | 4 | Wood screw 4.5x60 mm |
| M.13 | 4 | Dowel S8 |
| M.14 | 3 | Oval head screw with shank 2.5x6.5 mm stainless steel black (pre-assembled) |
| M.15 | 2 | Cover for screw plastic white |

Technical Specifications

This section contains the following information:

| | |
|---|-----------|
| Order Information | 22 |
| Hardware | 22 |
| Image and Video Properties | 25 |
| General Software Features | 25 |
| Video Analysis | 27 |
| Video Management Software | 27 |
| Sensor Modules | 27 |
| Functional Modules | 32 |
| Connector Box LSA / Connector Box RJ45 | 33 |
| Dimensions | 35 |

Order Information

| | |
|-------------|-------------|
| Name | MOBOTIX M73 |
| Order Code: | Mx-M73 |

Hardware

| Feature | Properties |
|------------------------------------|---|
| Image sensor (color or B&W sensor) | up to 4K UHD 3840x2160, 16:9, 1/1,8" |
| Light sensitivity | <ul style="list-style-type: none"> ▪ Color sensor (day): 0,1 lx @ 1/60s; 0,005 lx @ 1s ▪ BW sensor (night): 0,02 lx @ 1/60s; 0,001 lx @ 1s |
| Exposure control | Manual and automatic mode 1 s to 1/16,000 s |
| IK protection class | IK10 (housing) |
| IP / NEMA protection class | IP66 / NEMA 4X |
| Operating temperature range | -40 to 65 °C / -40 to 149 °F |
| Min. cold start temperature | -30 °C / -22 °F |
| Relative Humidity | 95 % non-condensing |
| Internal DVR Storage | Internal microSD card (SDHC/SDXC), 8 GB out of the box, max. 1 TB. |
| I/Os | see Connector Box LSA / Connector Box RJ45, p. 33 |
| Microphone/Speaker | <ul style="list-style-type: none"> ▪ Functional audio module, max. 4.5 Watt (see Functional Modules, p. 32) ▪ Microphone Sensitivity: -35 +/-4 dB (0 dB = 1 V/pa, 1 kHz) ▪ Speaker: 0.9 W at 8 Ohm |
| Passive infrared sensor (PIR) | Available with functional module, max. 4.5 Watt (see Functional Modules, p. 32) |
| Infrared illumination | Three functional modules for wide-angle, standard, and tele lenses |
| Range of infrared illumination | Up to 30 m/100 ft (may be more depending on scene) |

| Feature | Properties |
|--|--|
| Shock detector (tamper detection) | Yes |
| Max. power consumption | max. 25 W |
| Electrical surge protection | integrated with MOBOTIX integrated with Connector Box LSA (not part of the scope of delivery) |
| PoE standard | PoE Plus (802.3at-2009)/Class 4 |
| Interfaces | <ul style="list-style-type: none"> ▪ Ethernet 1000BaseT ▪ miniUSB / USB2.0 High-Speed ($V_{out} = 5,1V$, $I_{out} = 0,9A$, $P_{out} = 4,5W$) |
| Mounting Options | Wall- or pole-mountable (with Pole Mount accessory) |
| Dimensions (height x width x depth) | 228 x 153 x 232 mm |
| Weight without sensor modules | Approx. 2.5 kg/5.5 lb |
| Housing | Aluminum, PBT-30GF |
| Standard accessories | See M73: Scope of Delivery, p. 14 |
| Tiltability of camera | Horizontal: 2 x 180 degrees Vertical: 110 degrees |
| Detailed technical documentation | www.mobotix.com > Support > Download Center > Marketing & Documentation |
| MTBF | 80,000 hours |
| Certificates | EN 50121-4, EN 55032, EN 55035, EN 61000-6-1, EN 61000-6-2, EN 61000-6-3, EN 61000-6-4, EN 62368-1, EN 63000, AS/NZS CISPR32, 47 CFR Part 15b, NRTL |
| Protocols | DHCP (client and server), DNS, ICMP, IGMP v3, IPv4, IPv6, HTTP, HTTPS, FTP, FTPS, NFS, NTP (client and server), RTP, RTCP, RTSP, SFTP, SIP (client and server), SMB/CIFS, SNMP, SMTP, SSL/TLS 1.3, TCP, UDP, VLAN, VPN, Zero-conf/mDNS |
| Manufacturer warranty | 5 years |

Average Power Consumption

M73 - Body

Average power consumption: 8.5 W

M73 - D/N, IR, Audio

Modules:

M1: IR 850nm wide

M2: ULL Day/Night DN280

M3: Audio

Average power consumption: 15.4 W

M73 - D/N, IR, Multisense

Modules:

M1: IR 850nm wide

M2: ULL Day/Night DN280

M3: Multisense

Average power consumption: 14.1 W

M73 - D/N, Thermal, Audio

Modules:

M1: Thermografic Sensor 336R100

M2: ULL Day/Night DN280

M3: Audio

NOTE! Thermal overlay used as Live view.

Average power consumption: 12.2 W

M73 - D/N, Thermal, Multisense

Modules:

M1: Thermografic Sensor 336R100

M2: ULL Day/Night DN280

M3: Multisense

NOTE! Thermal overlay used as Live view.

Average power consumption: 11.5 W

M73 - D/N, Thermal, IR

Modules:

M1: Thermografic Sensor 336R100

M2: ULL Day/Night DN280

M3: IR 850nm wide

NOTE! Thermal overlay used as Live view.

Average power consumption: 16.5 W

Image and Video Properties

| Feature | Properties |
|-----------------------------|---|
| Available video codecs | <ul style="list-style-type: none"> ▪ H.264, H.265 ▪ MxPEG+ ▪ MJPEG |
| Image resolutions | VGA 640x360, XGA 1024x576, HD 1280x720, FullHD 1920x1080, QHD 2560x1440, 4K UHD 3840x2160 |
| Multi streaming | H.264, H.265 with triple streaming |
| Multicast stream via RTSP | Yes |
| Max. image H.264 resolution | <ul style="list-style-type: none"> ▪ One sensor: 4K UHD, 3840x2160 (8MP) ▪ Both sensors (dual image): 2x 4K UHD, 7680x2160 (16MP) |
| Max. frame rate | MxPEG: 20@4K, H.264: 30@4K, H.265: 30@4K |

General Software Features

| Feature | Properties |
|-------------------|---|
| WDR | Up to 120 dB |
| Software features | <ul style="list-style-type: none"> ▪ H.264, H.265 Multistreaming |

Technical Specifications

General Software Features

| Feature | Properties |
|------------------------------|---|
| | <ul style="list-style-type: none">▪ Multicast stream via RTSP▪ Digital pan, tilt, zoom/vPTZ (up to 8x zoom)▪ Genetec protocol integration▪ Programmable exposure zones▪ Snapshot recording (pre/post-alarm images)▪ Continuous recording▪ Event recording▪ Time-controlled flexible event logic▪ Weekly schedules for recordings and actions▪ Event video and image transfer via FTP and email▪ Playback and QuadView via web browser▪ Animated logos on the image▪ Master/Slave functionality▪ Privacy zone scheduling▪ Remote alarm notification (network message)▪ Programming interface (HTTP-API)▪ MxMessageSystem |
| ONVIF compatibility | Profile G, S, T, (M with later firmware release) |
| Master/Slave functionality | Yes |
| Remote alarm notification | email, network message (HTTP/HTTPS), SNMP, MxMessageSystem, MQTT |
| DVR/image storage management | <ul style="list-style-type: none">▪ On internal microSD card▪ On external USB and NAS devices▪ Different streams for live image and recording▪ MxPEG+ only▪ MxFFS with buffered archive, pre- and post-alarm images, storage monitoring with error reporting |
| Camera and data security | User and group management, SSL connections, IP-based access control, IEEE 802.1X, intrusion detection, digital image signature |
| Digitally signed firmware | Yes (to prevent firmware file tampering) |

Video Analysis

| Feature | Properties |
|------------------------|---|
| Video motion detection | Yes |
| MxActivitySensor | Version 1.0, 2.1, 3.0 and object-based MxAnalytics AI |
| MxAnalytics | Yes with a later FW release |
| MOBOTIX App support | Yes with a later FW release |

Video Management Software

| Feature | Properties |
|------------------------|---|
| MOBOTIX HUB | Yes www.mobotix.com > Support > Download Center > Software Downloads |
| MxManagementCenter | Yes (latest version recommended) www.mobotix.com > Support > Download Center > Software Downloads |
| MOBOTIX Cloud | Streaming & Events supported |
| MOBOTIX LIVE App | Yes (available in Google Play Store (Android) and Apple App Store (iOS)). |
| 3rd Party VMS Software | see ONVIF Profile S, T and G specification |

Sensor Modules

Dimensions of Sensor Modules

| | |
|--------------------------------|-------------------|
| Dimensions (height x width) | 58 x 42,5 (50 mm) |
|--------------------------------|-------------------|

Weight of Sensor Modules

| Sensor Module | Weight |
|-------------------------|-----------|
| Standard Sensor Modules | max. 150g |
| Functional Modules | max. 150g |
| Thermal Sensor Module | 380g |
| PTMount Thermal | 890g |

Supported Image Sensor Modules

| Sensor Module | Order Code |
|--|-------------------|
| Sensor module with standard 45° lens | Mx-O-M7SA-8DN100* |
| | Mx-O-M7SA-8D100 |
| | Mx-O-M7SA-8N100* |
| | Mx-O-M7SA-4DN100 |
| Sensor module with tele lens 30° | Mx-O-M7SA-8DN150* |
| | Mx-O-M7SA-8D150 |
| | Mx-O-M7SA-8N150* |
| | Mx-O-M7SA-4DN150 |
| | Mx-O-M7SA-8L150 |
| Sensor module with tele lens 15° | Mx-O-M7SA-8DN280* |
| | Mx-O-M7SA-8D280 |
| | Mx-O-M7SA-8N280* |
| | Mx-O-M7SA-4DN280 |
| | Mx-O-M7SA-8L280 |
| Sensor module with tele lens 8° | Mx-O-M7SA-8D500 |
| | Mx-O-M7SA-8N500 |
| | Mx-O-M7SA-8L500 |
| Sensor module with wide angle lens 60° | Mx-O-M7SA-8DN080* |
| | Mx-O-M7SA-8D080 |
| | Mx-O-M7SA-8N080* |
| | Mx-O-M7SA-4DN080 |

| Sensor Module | Order Code |
|--|--------------------|
| Sensor module with super wide angle lens 95° | Mx-O-M7SA-8DN050* |
| | Mx-O-M7SA-8D050 |
| | Mx-O-M7SA-8N050* |
| | Mx-O-M7SA-4DN050 |
| Sensor module with ultra wide angle lens 120° 4K | Mx-O-M7SA-8DN040* |
| | Mx-O-M7SA-8D040 |
| | Mx-O-M7SA-8N040* |
| | Mx-O-M7SA-4DN040 |
| | Mx-O-M7SA-8L040 |
| Sensor module with hemispheric lens 180° 12MP | Mx-O-M7SA-12DN016* |

*also available in black.

NOTE! Please consider any lens-related restrictions. For example, license plate recognition is not possible with a hemispheric lens.

For a complete list of lenses for MOBOTIX cameras, please see the Lens Table document for MOBOTIX 7 models on www.mobotix.com > [Support](#) > [Download Center](#) > [Marketing & Documentation](#) > [Lens Table](#).

Supported Thermal Sensor Modules (Pre-mounted on Thermal Front Plate)

| Sensor Module | Order Code |
|---------------------------------------|--------------------------|
| CIF Thermal 45° x 35° | MX-O-M73TB-336T100 |
| CIF Thermal 25° x 19° | Mx-O-M73TB-336T150 |
| CIF Thermal 17° x 13° | Mx-O-M73TB-336T280 |
| CIF Thermal Radiometry 45° x 35° | Mx-O-M73TB-336R100 |
| CIF Thermal Radiometry 25° x 19° | Mx-O-M73TB-336R150 |
| CIF Thermal Radiometry 17° x 13° | Mx-O-M73TB-336R280 |
| CIF Thermal Radiometry 9,3° x 7,1° | Mx-O-M73TB-336R500 (BTO) |

Technical Specifications

Sensor Modules

| Sensor Module | Order Code |
|-------------------------------------|--------------------------|
| VGA Thermal 90° x 69° | Mx-O-M73TB-640T050 |
| VGA Thermal 69° x 56° | Mx-O-M73TB-640T080 |
| VGA Thermal 45° x 37° | Mx-O-M73TB-640T100 |
| VGA Thermal 32° x 26° | Mx-O-M73TB-640T150 |
| VGA Thermal 18° x 14° | Mx-O-M73TB-640T280 |
| VGA Thermal Radiometry 90° x 69° | Mx-O-M73TB-640R050 |
| VGA Thermal Radiometry 69° x 56° | Mx-O-M73TB-640R080 |
| VGA Thermal Radiometry 45° x 37° | Mx-O-M73TB-640R100 |
| VGA Thermal Radiometry 32° x 26° | Mx-OM73TB-640R150 |
| VGA Thermal Radiometry 18° x 14° | Mx-O-M73TB-640R280 (BTO) |

The **Thermal Radiometry (TR)** variants automatically alarm when the temperature exceeds or falls below defined limits. This is crucial for the detection of fire or heat sources. Up to 20 different temperature events can be configured simultaneously in so-called TR windows or over the complete sensor image over a temperature range of High Sensitivity: -40 to 170 °C/-40 to 320 °F -- Low Sensivity: -40 to 550 °C/-40 to 1022 °F . The **Thermal (non-TR)** variants only measure in the center of the image (Thermal spot, 2x2 pixel).

Features Thermal Image Sensors

| Feature | Properties |
|--|--|
| Thermal sensitivity | Typ. 50 mK, IR range 7.5 to 13.5 µm |
| Temperature measurement range (adjustable) | High Sensitivity: -40 to 170 °C/-40 to 320 °F -- Low Sensivity: -40 to 550 °C/-40 to 1022 °F |
| Thermal image sensor | Uncooled microbolometer, CIF: 336 x 256 pixels / VGA: 640 x 480 |
| Dimensions | 336/640: 48,5x48,5x70 170g without front plate / 265g with front plate |
| Max. image size | Can be scaled up to 3072 x 2048 (6MP), automatically scaled to size of MX |

| Feature | Properties | | | | | | | | | | | | | | | | | | | | |
|-----------------------|---|---------------|-----|------------|--|------------|---------------------------------------|------------|---------------------------------------|------------|--|------------|---------------------------------------|------------|-------------------------------------|------------|---------------------------------------|------------|---------------------------------------|------------|--|
| | sensor module | | | | | | | | | | | | | | | | | | | | |
| Max. frame rate | 9fps (-FAST version 25/30fps on request) | | | | | | | | | | | | | | | | | | | | |
| Pixel pitch | 17 μ m | | | | | | | | | | | | | | | | | | | | |
| Field of view | <table border="1"> <thead> <tr> <th>Sensor Module</th> <th>FoV</th> </tr> </thead> <tbody> <tr> <td>336 xx 100</td> <td>45° x 35°; 2.27mr, focal 7.5mm, f/1.25</td> </tr> <tr> <td>336 xx 150</td> <td>25° x 19°; 1.31mr, focal 13mm, f/1.25</td> </tr> <tr> <td>336 xx 280</td> <td>17° x 13°; 0.90mr, focal 19mm, f/1.25</td> </tr> <tr> <td>336 xx 500</td> <td>9° x 7°; 0.486mr, focal length 35mm, f/1.5</td> </tr> <tr> <td>640 xx 050</td> <td>90° x 69°; 2.27mr, focal 7.5mm, f/1.4</td> </tr> <tr> <td>640 xx 080</td> <td>69° x 56°; 1.89mr, focal 9mm, f/1.4</td> </tr> <tr> <td>640 xx 100</td> <td>45° x 37°; 1.31mr, focal 13mm, f/1.25</td> </tr> <tr> <td>640 xx 150</td> <td>32° x 26°; 0.90mr, focal 19mm, f/1.25</td> </tr> <tr> <td>640 xx 280</td> <td>18°x14°; 0.486mr, focal length 35mm, f/1.5</td> </tr> </tbody> </table> | Sensor Module | FoV | 336 xx 100 | 45° x 35°; 2.27mr, focal 7.5mm, f/1.25 | 336 xx 150 | 25° x 19°; 1.31mr, focal 13mm, f/1.25 | 336 xx 280 | 17° x 13°; 0.90mr, focal 19mm, f/1.25 | 336 xx 500 | 9° x 7°; 0.486mr, focal length 35mm, f/1.5 | 640 xx 050 | 90° x 69°; 2.27mr, focal 7.5mm, f/1.4 | 640 xx 080 | 69° x 56°; 1.89mr, focal 9mm, f/1.4 | 640 xx 100 | 45° x 37°; 1.31mr, focal 13mm, f/1.25 | 640 xx 150 | 32° x 26°; 0.90mr, focal 19mm, f/1.25 | 640 xx 280 | 18°x14°; 0.486mr, focal length 35mm, f/1.5 |
| Sensor Module | FoV | | | | | | | | | | | | | | | | | | | | |
| 336 xx 100 | 45° x 35°; 2.27mr, focal 7.5mm, f/1.25 | | | | | | | | | | | | | | | | | | | | |
| 336 xx 150 | 25° x 19°; 1.31mr, focal 13mm, f/1.25 | | | | | | | | | | | | | | | | | | | | |
| 336 xx 280 | 17° x 13°; 0.90mr, focal 19mm, f/1.25 | | | | | | | | | | | | | | | | | | | | |
| 336 xx 500 | 9° x 7°; 0.486mr, focal length 35mm, f/1.5 | | | | | | | | | | | | | | | | | | | | |
| 640 xx 050 | 90° x 69°; 2.27mr, focal 7.5mm, f/1.4 | | | | | | | | | | | | | | | | | | | | |
| 640 xx 080 | 69° x 56°; 1.89mr, focal 9mm, f/1.4 | | | | | | | | | | | | | | | | | | | | |
| 640 xx 100 | 45° x 37°; 1.31mr, focal 13mm, f/1.25 | | | | | | | | | | | | | | | | | | | | |
| 640 xx 150 | 32° x 26°; 0.90mr, focal 19mm, f/1.25 | | | | | | | | | | | | | | | | | | | | |
| 640 xx 280 | 18°x14°; 0.486mr, focal length 35mm, f/1.5 | | | | | | | | | | | | | | | | | | | | |
| Operating temperature | -40° to +65°C / 40° to 149°F; 5% to 95% non-condensing | | | | | | | | | | | | | | | | | | | | |
| Power consumption | CIF: 1W VGA: 1.2W | | | | | | | | | | | | | | | | | | | | |
| MTBF | 80,000 hours | | | | | | | | | | | | | | | | | | | | |
| IP rating | IP67 | | | | | | | | | | | | | | | | | | | | |
| IK rating | IK04 | | | | | | | | | | | | | | | | | | | | |
| Material | PBT-30GF (housing); Germanium (lens) | | | | | | | | | | | | | | | | | | | | |
| Software (included) | Video management software MxManagementCenter | | | | | | | | | | | | | | | | | | | | |

Features ECO Thermal Image Sensor

| Feature | Properties |
|-------------------------------|--|
| Thermal sensitivity | Typ. 65 mK, IR range 7.8 to 14 μ m |
| Temperature measurement range | -40 to 330°C/ -40 to 626 °F |
| Field of view | T040: 105 x 75°; 5,23mr, focal 2.2mm, f/1.05 |

Technical Specifications

Functional Modules

| Feature | Properties |
|-----------------------|---|
| | T080: 56 x 42°; 3,00mr, focal 4.0mm, f/1.00 |
| Thermal image sensor | Uncooled microbolometer, CIF: 320 x 240 pixels |
| Dimensions | 58 x 42.5 mm (dia. 50 mm), 65g |
| Pixel pitch | 12µm |
| Max. image size | Can be scaled up to 3072 x 2048 (6MP), automatically scaled to size of MX Sensor module |
| Max. frame rate | 9 fps (when displaying an Mx Sensor module and a thermal sensor module, the overall frame rate of the camera is reduced to 9 fps) |
| Operating temperature | -40° to +65°C / 40° to 149°F; 5% to 95% non-condensing |
| Power consumption | 600mW |
| IP rating | IP66 |
| IK rating | IK04 |
| Material | PBT-30GF (housing); Chalcogenide (lens) |
| Software (included) | Video management software MxManagementCenter |

Functional Modules

| Functional Module | Order Code | Remark |
|------------------------------|------------|---|
| Audio module | Mx-F-AUDA | Audio module with microphone and speaker |
| Functional MultiSense module | Mx-F-MSA | with PIR sensor, temperature sensor, illumination sensor |
| Functional IR Light modules | Mx-F-IRA-W | for Super Wide-Angle Lens Sensor Modules 95° |
| | Mx-F-IRA-S | for Standard & Wide-Angle Lens Sensor Modules 45° and 60° |
| | Mx-F-IRA-T | for Tele Lens Sensor Modules 15° and 30° |
| | | Power consumption IR Light Modules: |

| Functional Module | Order Code | Remark |
|---------------------|------------|---|
| White Light Modules | Mx-F-WLA-W | 4,2 W at 100% brightness. for Super Wide-Angle Lens Sensor Modules 95° |
| | Mx-F-WLA-S | for Standard & Wide-Angle Lens Sensor Modules 45° and 60° |
| | Mx-F-WLA-T | for Tele Lens Sensor Modules 15° and 30° |
| | | Power consumption White Light Modules: 3,2 W at 100% brightness. |

Connector Box LSA / Connector Box RJ45

| Interface | Properties | |
|--|--|---|
| Network | 100/1000 Mbps | |
| Overvoltage Protection | max. 4 kV on the PoE network cabling | |
| Allowed cable dimensions for cables connected to the PCB terminals | <i>Conductor cross section</i> | |
| | AWG | 20 - 26 |
| | Rigid | 0.14mm ² - 0.5mm ² |
| | Flexible | 0.14mm ² - 0.5mm ² |
| | Flexible with ferrule | 0.25mm ² - 0.34mm ² |
| Line In | Standard Line In: (0dB) V _{rms} =1V | |

Technical Specifications

Connector Box LSA / Connector Box RJ45

Interface

Properties

Line Out

Headphones with 20mW @ 16 Ohm or 32 Ohm.

Audio inputs as a Line Out function to 10k Ohm impedance of receiver. Audio level while connected to 10k Ohm equals -10dbV

IN / OUT

INPUT

- Contact Closure (no galvanic isolation necessary) or up to 30 Vrms AC / 50V DC
- Switching thresholds
Input >1.6V leads to a detected HIGH
Input <0.9V leads to a detected LOW (after a high)
- max. length for cables: 50m

OUTPUT

- requires pull-up resistor and external power supply (10mA / max. 50V DC - no AC)
 - Output may be loaded with max. 50mA
 - max. length for cables: depends on loop impedance of the connected cable.
-

Dimensions

NOTE! Download the drilling template from the MOBOTIX website: www.mobotix.com > Support > Download Center > Marketing & Documentation > Drilling Templates.

CAUTION! Always print or copy the drilling template at 100% of the original size!

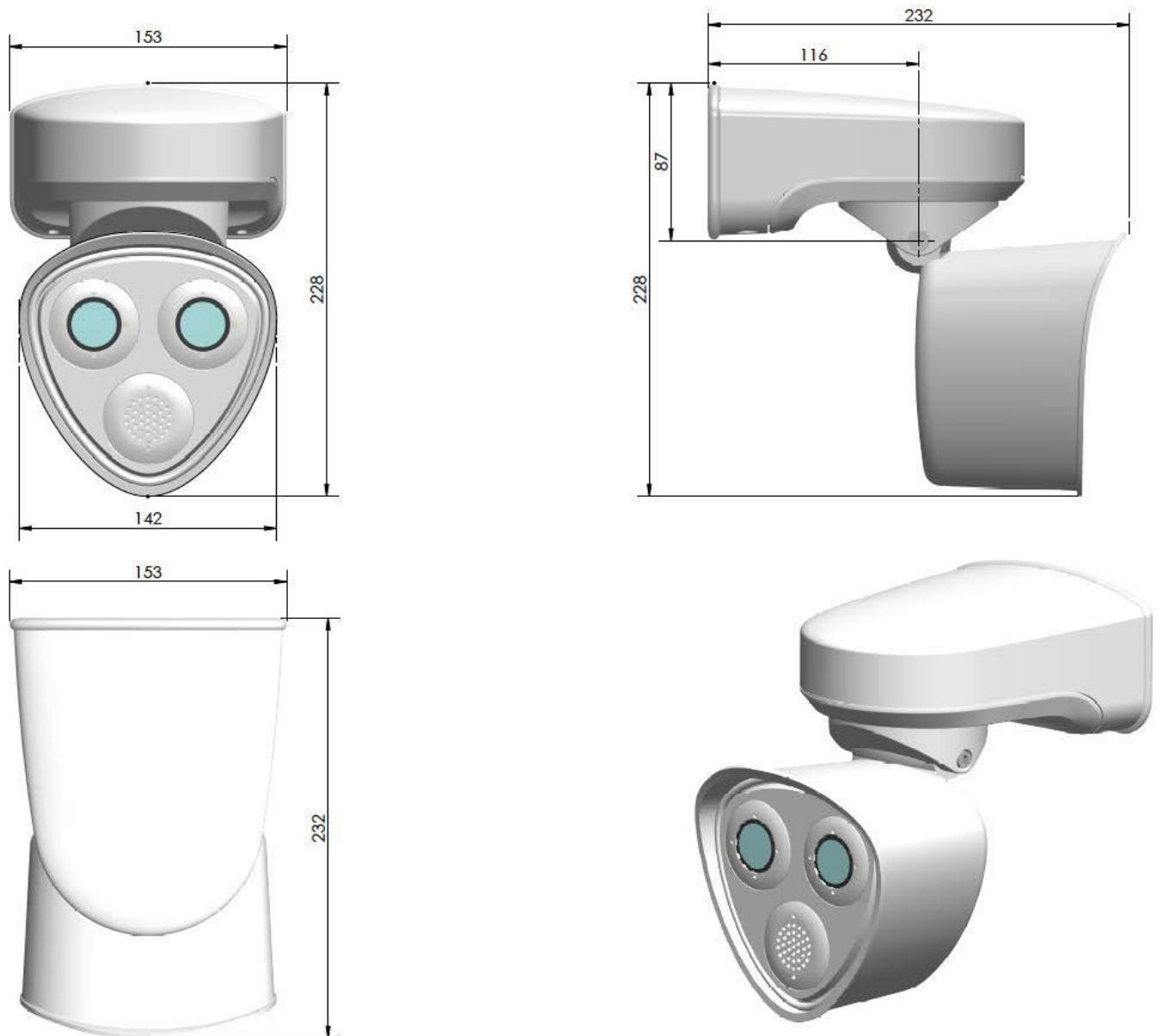

Fig. 4: MOBOTIX M73: All measurements in mm

Mounting

This section contains the following information:

| | |
|---|-----------|
| Before Mounting the Camera | 38 |
| Installing Sensor Modules | 40 |
| Installing a Thermal Front Plate | 50 |
| Installing Security Screws | 59 |
| Mounting Options | 61 |
| Connecting the camera | 70 |
| Finishing the Installation of the Camera | 82 |

Before Mounting the Camera

CAUTION! Before mounting the camera make sure to copy the IP address ① on the back of the camera housing or on the camera packaging. You will need this address to configure the camera in the browser later on (see [Camera Software in the Browser](#), p. 101).



Fig. 5: IP address on the back of the camera housing

The MOBOTIX M73 has been designed for wall mounting. Using the pole mount accessory, you can also install the camera on a pole (see [Mounting Options](#), p. 61).

NOTE! Download the drilling template from the MOBOTIX website: www.mobotix.com > [Support](#) > [Download Center](#) > [Marketing & Documentation](#) > [Drilling Templates](#).

CAUTION! Always print or copy the drilling template at 100% of the original size!

Before mounting the MOBOTIX M73, the following questions should be answered:

- Where and how will the camera be mounted?
- How is the mounting surface level?
- Which other mounting options are available?
- Which accessories might be needed?
- How is the camera connected to the network and how is the power supplied?
- How are the connections furnished from the building?
- What cabling considerations are necessary?
- Do you want to use a larger SD card (see [Replacing the microSD card](#), p. 109)?

The following sections will answer these questions. If you have further questions, please ask your MOBOTIX partner or contact the MOBOTIX support under www.mobotix.com > [Support](#) > [Help Desk](#).

Protective Measures

WARNING! When laying cables indoors and outdoors, the current regulations for cable laying, lightning and fire protection must always be observed.

MOBOTIX cameras and devices are protected against the effects of minor over voltages by a number of measures. However, these measures cannot prevent larger surge voltages from causing damage to the camera. When installing the cameras outdoors, special attention should therefore be paid to lightning protection and the associated dangers for the building and network infrastructure.

In general, you should only have MOBOTIX cameras and devices installed by certified specialist companies that are familiar with the installation and safe operation of network devices and the underlying regulations for lightning and fire protection as well as the current technology for preventing damage from surge voltages.

Notes on Cable Laying

- **Data cable:** Only double-shielded CAT5 cable or better (S/STP) may be used as data cable for the Ethernet interface.

NOTE! For outdoor use, special requirements apply for the cables to be used and the lightning protection.

- **Cable length:** The individual cable sections must not exceed the maximum permissible lengths in order to ensure perfect data transmission.
- **Avoidance of induction:** Data cables may only be laid parallel to power or high-voltage lines if the prescribed minimum distances are observed.
- Only use MOBOTIX cables and connectors to ensure IP66 weather resistance.

Fire Protection

When laying cables for the power supply, the relevant country-specific regulations (e.g. VDE in Germany) and the fire protection regulations valid at the installation site must be observed.

Lightning and Surge Protection

Measures should always be taken to protect this device from electrical surge damage.

NOTE! Electrical surge protection is integrated in the Connector Box LSA (see [Network connection with the Connector Box LSA, p. 71](#)), which is available as an accessory.

Further information on how to avoid damage caused by lightning and over voltage is available from manufacturers of lightning and over voltage protection devices.

Installing Sensor Modules

WARNING! Make sure the power supply to the camera is disconnected before installing or replacing sensor modules.

WARNING! When installing the sensor modules or closing the module housing, make sure that the sensor module cables are not damaged or bent sharply.

CAUTION! Do not operate the camera until all three module receptacles have been fitted with sensor modules or blind modules.

NOTE! Upon delivery, the sensor module sockets in the front plate [1.3](#) are fitted with transport plugs [1.4](#). When operating the camera, it needs to be fitted either with sensor or blind modules [1.5](#). This closes off the front plate and protects the camera against foreign objects, animals and water.

Procedure

1. **Prepare the sensor module:** Remove the bayonet catch by rotating it counter-clockwise, then remove the blue rubber plug.



NOTE! If the plastic nut has been installed, remove it. This nut will **not** be used any more in the mounting process.

2. **Remove the transport plugs:** Gently pull the transport plugs out of the sensor module receptacles and pull the plugs from the sensor module cables.

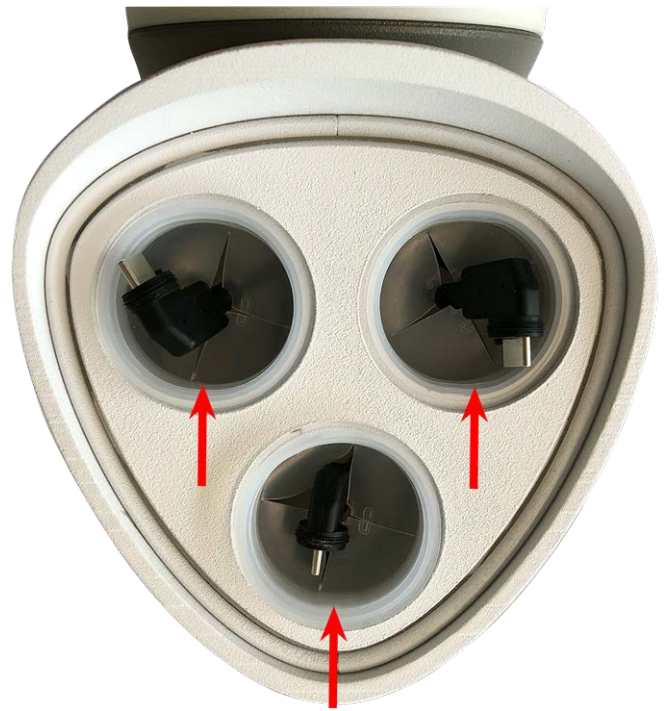

CAUTION! In order to avoid damage cautiously pull the sensor module cables out of the housing until you feel the stop!

3. Properly assign the sensor module cables.

The sensor module cables are numbered (small colored rings next to the connectors).

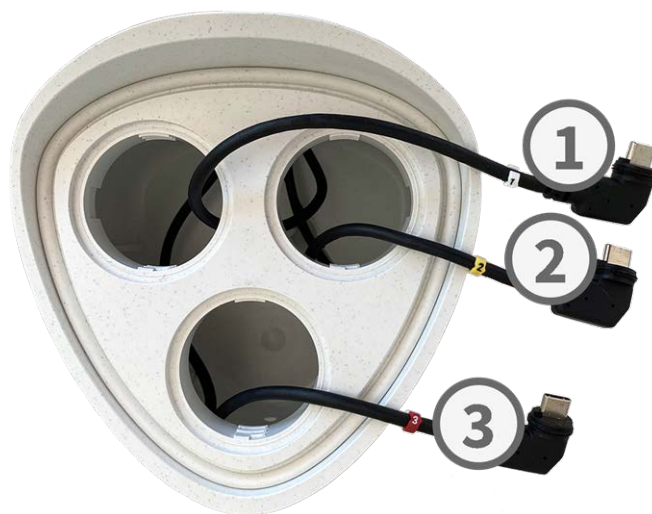

CAUTION!

When attaching sensor modules, make sure that these rules are followed:

- The MOBOTIX M73 can be equipped with these types of modules:
 - A maximum of two optical modules can be used.
 - A maximum of two functional modules can be used.
 - One thermal module can be used instead of one **optical** module (see [Installing the Sensor Modules to the Thermal Front Plate, p. 56](#)).

Applicable to newer thermal sensor module types Mx-O-M7SB-640R050, Mx-O-M7SB-640T050, Mx-O-M7SB-336R100, MX-O-M7SB-336T100 (see [Technical Specifications, p. 21](#)):

- Use the following sensor module cables for these types of modules:
 - **Cables ① and ②** : Optical, functional or thermal modules. **No audio module.**
 - **Cable ③** : Functional or thermal modules. **No optical modules.**

Applicable to other thermal sensor module types (see [Technical Specifications, p. 21](#)):

- Use the following sensor module cables for these types of modules:
 - **Cables ① and ②** : Optical or functional modules. **No thermal modules, no audio module.**
 - **Cable ③** : Functional or thermal modules. **No optical modules.**

When positioning the modules, you are free to choose the individual module positions (with the exception of the thermal sensor module, since it is pre-installed on a special front plate).

4. **Properly connect the sensor module cables:**

Push the plug of each sensor module cable **firmly** into the connector at the back of the module until the connector is fully inserted into its seat until it doesn't go in any further.



CAUTION! The lug of the plug must point to the inside of the sensor module when plugged in. If the module cable is not plugged in correctly, the sensor will not be recognized by the camera.

NOTE!

When using blind modules, also insert the connector into the receptacle as shown below.



Mounting

Installing Sensor Modules

5. **Lock sensor module cable:** Apply the blue bayonet catch onto the connector of the sensor module as shown and turn it clockwise until it gently snaps shut.



6. **Insert sensor module:** Push the sensor module into its receptacle. The arrow on the back of the module points to 9 o'clock when looking at the module as shown.



7. **Lock the sensor module:** Using the gray module wrench [M.1](#), turn the sensor module clockwise until it stops.



CAUTION! If you cannot turn the sensor module, it has been inserted the wrong way! Remove the sensor module, rotate it by 180 degrees and insert it again.

8. Repeat steps 3 to 6 for the remaining sensor modules or the blind module [1.5](#), respectively.

CAUTION!

The sensor modules are not yet protected against theft and unwanted rotation (e.g. due to vibration). It is thus highly recommended to install the security clips [M.4](#). Proceed as outlined in the following:



- [Opening the Module Housing, p. 45](#)
- [Installing the Security Clips, p. 47](#)
- [Closing the Module Housing, p. 48](#)

If you do **not** want to install the security clips, proceed by selecting the [Mounting Options, p. 61](#).

Opening the Module Housing

The following tasks require opening the module housing:

- Inserting security clips at the sensor module or the blind module, respectively.
- Exchanging a sensor or blind module when secured with security clips.
- Replacing the default front plate [1.3](#) with a thermal front plate or vice versa.

Mounting

Installing Sensor Modules

1. Remove the rubber plug at the back of the module housing (e.g., by using a small screwdriver).



2. Using the supplied 5 mm Allen wrench [M.6, p. 18](#), release the bolt at the back of the module housing. Leave the bolt and washer in the module housing.



3. Using the Allen wrench, **cautiously** push from behind onto the bolt and push the front plate out of the front of the housing.



Installing the Security Clips

CAUTION!

To prevent module rotation or removal it is highly recommended to install the security clips.



The security clips [M.4](#) are protecting the sensor modules or the blind module in the front plate of the MOBOTIX M73 against theft and unwanted rotation (e.g., due to vibration when mounted on a pole or in an automotive scenario).

CAUTION!

Do not use the plastic nuts delivered with the sensor modules to lock the modules in place!



Mounting

Installing Sensor Modules

1. **Open the module housing** (see [Opening the Module Housing, p. 45](#)).
2. **Insert the security clips:** Insert a security clip into the groove between the inner and the outer thread of the sensor module. Press it all the way into the groove and make sure it snaps in under the head of the pre-assembled screw ① .



3. **Repeat step 2** to apply security clips to all modules.
4. **Close the module housing:** (see [Closing the Module Housing, p. 48](#)).

Closing the Module Housing

Insert the front plate of the MOBOTIX M73 to close the module housing.

1. Make sure that the arrow of the front plate (red circle in figure) points upwards when inserting the front plate into the module housing (figure shows front plate with cables removed).



2. Push the front plate into the module housing until it stops.

CAUTION! When pushing the front plate into the module housing, make sure that the sensor module cables are not damaged or bent sharply!



3. Using the supplied 5 mm Allen wrench [M.6](#), tighten the bolt at the back of the camera housing.

Mounting

Installing a Thermal Front Plate

4. Push the rubber plug back into the opening of the screw to prevent humidity and dirt from entering the camera.



Installing a Thermal Front Plate

Since the thermal sensor module is permanently attached to the Thermal Front Plate, you need to replace the entire standard front plate.

Upon delivery, two of three available sensor module sockets in the thermal front plate are fitted with transport plugs [1.4](#). When operating the camera, they need to be fitted either with sensor or blind modules [1.5](#). This closes off the front plate and protects the camera against foreign objects, animals and water.



WARNING! Only replace the sensor modules when the camera is disconnected from the power supply. Make sure the power supply to the camera is disconnected before installing or replacing sensor modules.

CAUTION! Do not operate the camera until all three receptacles have been fitted with sensor or blind modules.

CAUTION! When installing the sensor modules, make sure that the sensor module cables are not damaged or bent sharply.

Open the Module Housing

To remove the factory-installed front plate, open the camera housing as outlined in [Opening the Module Housing, p. 45](#)

Removing the Security Clips

NOTE! The procedure below only applies if you are adding a thermal front plate to a “regular” M73. If this is not the case, you can proceed to [Installing the Sensor Modules to the Thermal Front Plate, p. 56](#).

The security clips are protecting the sensor modules or the blind module in the front plate of the MOBOTIX M73 against theft and unwanted rotation (e.g., due to vibration when mounted on a pole or in an automotive scenario). If they are installed, you need to remove them before you can remove the sensor modules.



Procedure

1. **Open the module housing** (see [Opening the Module Housing, p. 45](#)).
2. **Remove the security clips:** Push the security clip slightly towards the sensor module ① and pull it out of its seat ② .

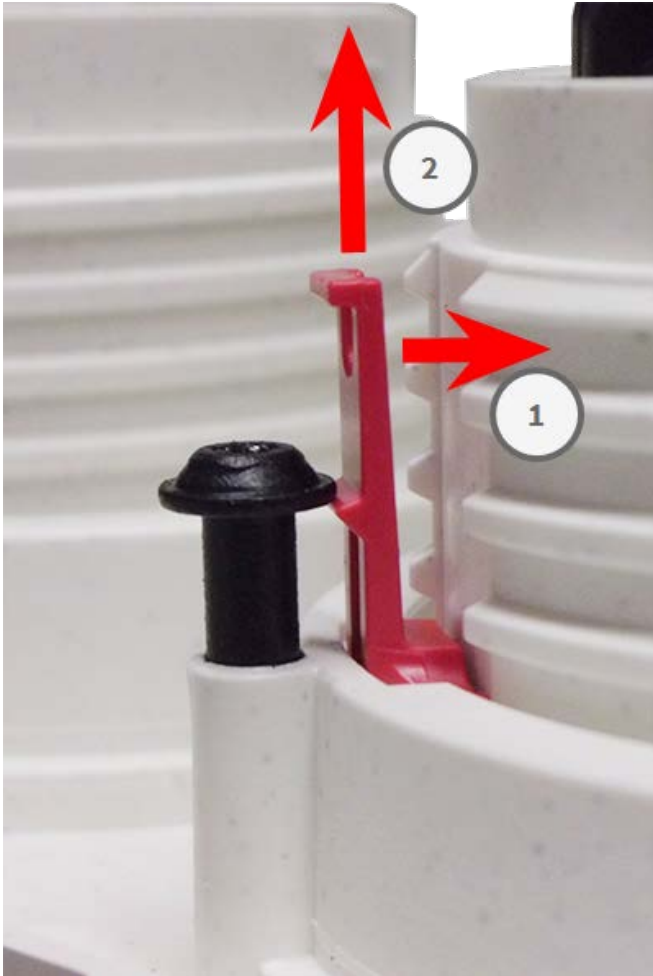

Fig. 6: Remove a security clip

3. Repeat steps 1 and 2 to remove the other security clips.

Proceed by [Removing Installed Sensor Modules, p. 52](#).

Removing Installed Sensor Modules

In some cases, e.g., when replacing modules, you need to remove the sensor modules. It's the same procedure for both, the default front plate and the thermal front plate.

CAUTION! Do not operate the camera until all three receptacles have been fitted with sensor or blind modules.

WARNING! Only replace the sensor modules when the camera is disconnected from the power supply. Make sure the power supply to the camera is disconnected before installing or replacing sensor modules.

WARNING! When installing the sensor modules, make sure that the sensor module cables are not damaged or bent sharply.

Procedure

1. **Remove security clips:** If any security clips are installed, remove them (see [Removing the Security Clips](#), p. 51).
2. **Unlock sensor module cable:** Turn the blue bayonet catch counterclockwise from the connector of the sensor module until it releases and remove it.



Fig. 7: Unlock sensor module cable

Mounting

Installing a Thermal Front Plate

3. **Remove sensor module cable:** Pull the plug of the sensor module cable from the connector at the back of the sensor module.



Fig. 8: Remove the sensor module cable

4. **Unlock the sensor module:** Using the gray module wrench [M.1](#), turn the sensor module counter-clockwise until it stops.



Fig. 9: Unlock the sensor module

5. **Remove sensor module:** Pull the sensor module from its receptacle.



Fig. 10: Remove sensor module from the module housing

Mounting

Installing a Thermal Front Plate

- Repeat steps 1 to 3 for the remaining sensor modules.

Installing the Sensor Modules to the Thermal Front Plate

Since the Thermal module is pre-installed, you only need to install additional sensor modules (functional or optical).

- Prepare the sensor module:** Remove the bayonet catch by rotating it counter-clockwise, then remove the blue rubber plug.

CAUTION! If the plastic nut has been installed, remove it.
This nut will **not** be used any more in the mounting process.



- Insert sensor/functional modules into Thermal front plate:** Push the sensor module into its receptacle. The arrow on the back of the module points to 9 o'clock when looking at the module as shown.



3. **Lock the sensor module:** Using the gray module wrench [M.1](#), turn the sensor module clockwise until it stops.



CAUTION! If you cannot turn the sensor module, it has been inserted the wrong way! Remove the sensor module, rotate it by 180 degrees and insert it again.

4. Properly connect the sensor module cables:

The sensor module cables are numbered (small colored rings next to the connectors, see figure below).

CAUTION!

When attaching sensor modules, make sure that these rules are followed:

- The MOBOTIX MOBOTIX M73 can be equipped with these types of modules:
 - A maximum of two optical modules can be used.
 - A maximum of two functional modules can be used.
 - One thermal module can be used instead of one **optical** module (see [Installing the Sensor Modules to the Thermal Front Plate, p. 56](#)).

Applicable to newer thermal sensor module types Mx-O-M7SB-640R050, Mx-O-M7SB-640T050, Mx-O-M7SB-336R100, MX-O-M7SB-336T100 (see [Technical Specifications, p. 21](#)):

- Use the following sensor module cables for these types of modules:
 - **Cables ① and ②** : Optical, functional or thermal modules. **No audio module.**
 - **Cable ③** : Functional or thermal modules. **No optical modules.**

Applicable to other thermal sensor module types (see [Technical Specifications, p. 21](#)):

- Use the following sensor module cables for these types of modules:
 - **Cables ① and ②** : Optical or functional modules. **No thermal modules, no audio module.**
 - **Cable ③** : Functional or thermal modules. **No optical modules.**

When positioning the modules, you are free to choose the individual module positions (with the exception of the thermal sensor module, since it is pre-installed on a special front plate).

Push the plug of each sensor module cable **firmly** into the connector at the back of the module until the connector is fully inserted into its seat. **If this is not the case, again push the connector firmly into its seat until it doesn't go in any further.**



5. **Lock sensor module cable:** Apply the blue bayonet catch onto the connector of the sensor module as shown and turn it clockwise until it gently snaps shut.



6. Repeat steps 3 to 6 for the remaining sensor modules or the blind module [1.5](#), respectively.

CAUTION! The sensor modules are not yet protected against theft and unwanted rotation (e.g., due to vibration). It is thus highly recommended to install the security clips [M.4](#). Proceed as outlined in [Installing the Security Clips, p. 47](#).

7. Proceed with [Closing the Module Housing, p. 48](#).

Installing Security Screws

For theft protection, the standard housing screws can be replaced by security screws.

NOTE! The security screws are not included in the standard scope of delivery and can be ordered separately (order number: Mx-M-SEC-SCREWS-SET).

The set contains a total of 7 security screws with pin, a special tool to loosen the security screws to loosen the safety screws, and 4 cover caps (2 for direct installation and 2 as replacements).

WARNING! Make sure the power supply to the camera is disconnected before installing or replacing the security screws.

Mounting

Installing Security Screws

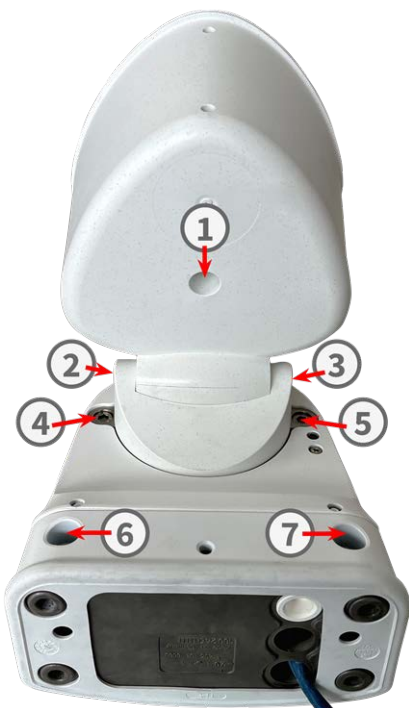

NOTE! To ensure basic stability of the camera during the replacement procedure, you should replace one screw at a time.

1. If applicable remove the rubber plug from the relevant housing screws (see figure above).
2. Using the supplied 5 mm Allen wrench [M.6, p. 18](#), remove the screw.
3. Using the special tool, replace the standard screw with a safety screw of the same size.
4. Repeat the steps for the remaining standard housing screws.
5. To prevent humidity and dirt from entering the camera, push the rubber plugs back into the openings of the screws ① , ⑥ and ⑦



6. Push the new plastic plugs into the openings of the screws ② and ③ .



Mounting Options

You can mount the MOBOTIX M73 to any even surface on a wall or to poles with up to 180 mm/7.1" diameter using the stainless steel pole mount that is available as accessory. The concealed cabling improves security of the installation.

CAUTION! Installation only on flat surface! Unevenness must not exceed 0.5 mm/0.02 in!
Only use genuine MOBOTIX patch cables to guarantee the weatherproofness!

The [mounting plate C.1](#) has been dimensioned to fully cover conventional flush-mounted sockets (without frame) or cavity sockets.

NOTE! Before mounting the camera, determine its ideal position and make sure that the field of view is not obstructed in any way. Once the camera has been mounted, you can fine-tune the image. If the monitored area changes or the camera has to be installed in a different location, you can simply exchange the sensor modules.

Tiltability when mounted

- horizontally: 2 x 180 degrees
- vertically: 110 degrees

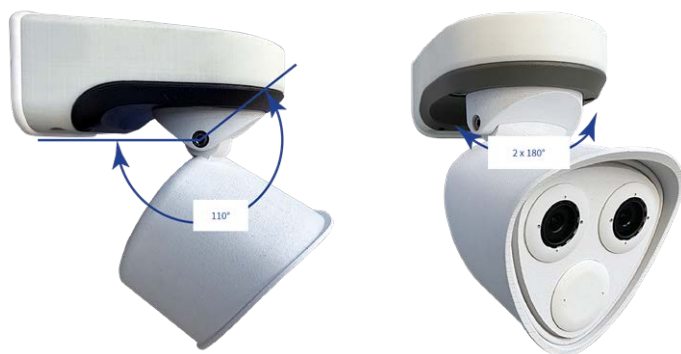

Mounting to a Wall

Before mounting the camera, make sure that a network connection with power supply according to the PoE Plus (802.3at-2009) standard is available at the mounting position (see [Connecting the Camera to the Network](#), p. 70).

NOTE! Download the drilling template from the MOBOTIX website: www.mobotix.com > [Support](#) > [Download Center](#) > [Marketing & Documentation](#) > [Drilling Templates](#).

Mounting

Mounting Options

CAUTION! Always print or copy the drilling template at 100% of the original size!

NOTE! Do not use the dowels if the installation surface is wood. Only use the screws to fasten the mounting plate directly on the surface. In order to facilitate screwing in wood, the positions should first be pre-drilled using a 2 mm drill bit, for example (drilling depth just slightly less than screw length).

Preparing the Wall

1. Mark the holes for drilling using the drilling template (see [Drilling Template, p. 11](#)). When drilling, use a suitable 8 mm drill bit and drill holes with at least 60 mm/1.2" depth.
2. Fully push the dowels [M.13](#) into the holes you drilled.

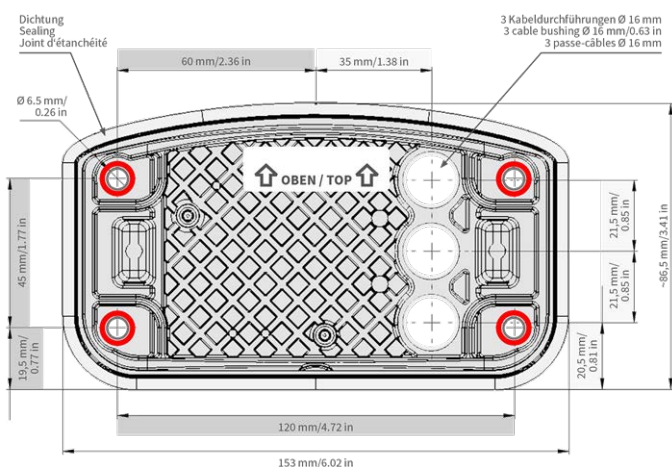

Prepare the Mounting Plate when using the Connector Box RJ45

1. Connect the supplied patch cable [1.4](#) of the camera with the network connection of the building (see [Connecting the Camera to the Network, p. 70](#)).

CAUTION! To prevent damage from condensation, using supplied patch cable [1.4](#) with sealing is mandatory.



2. The supplied network cable 1.4 has an integrated rubber sealing. Push the network cable through the top hole of the mounting plate, so that the funnel of the rubber plug ① points toward the camera.



Prepare the Mounting Plate when using the Connector Box LSA

1. Cut the tip of the upper white plug in the mounting plate ① and two steps of the lower white plug in the mounting plate ② :

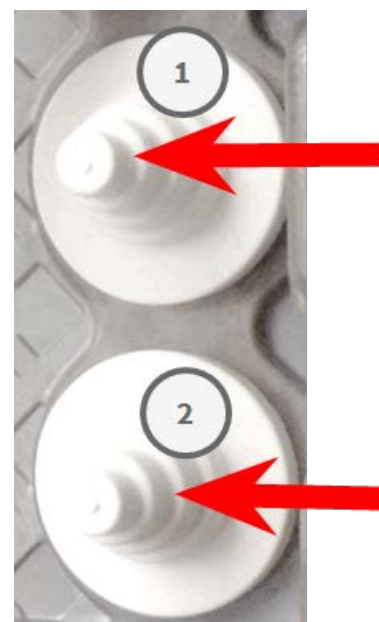

2. Rearrange the plugs in the mounting plate as required.

Mounting

Mounting Options

3. Guide the ground wire through the upper cable plug ① and the network cable through the lower cable plug ② of the mounting plate as shown:

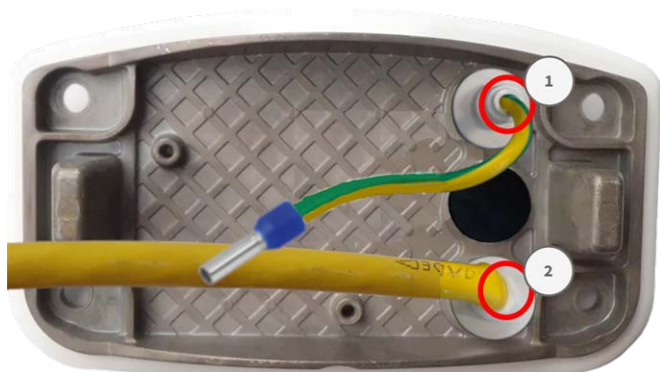

Installing the Mounting Plate

Place the mounting plate over the drilled holes (red circles in figures below) and use the four screws [M.12](#) with one washer [M.11](#) each and the TORX wrench TX20 [M.8](#) to mount the plate to the wall.

CAUTION! Install on flat surface only. Unevenness must not exceed 0.5 mm/0.02 in.

Connector Box RJ45



Fig. 11: Installed and ready for Connector Box RJ45

Connector Box LSA



Fig. 12: Installed and ready for Connector Box LSA

Mounting to a Pole

CAUTION! Before mounting the camera, make sure that a network connection with power supply according to the PoE Plus (802.3at-2009) standard is available at the mounting position (see [Connecting the Camera to the Network](#), p. 70).

CAUTION! The mounting pole should have a diameter between 60 and 180 mm.

Dimensions of the MOBOTIX M73 pole mount



Fig. 13: Dimensions M73 pole mount - rear view

Mounting

Mounting Options



Prepare the Pole Mount

1. Guide the supplied stainless steel straps along the cutouts in the Pole Mount as shown in the figure.

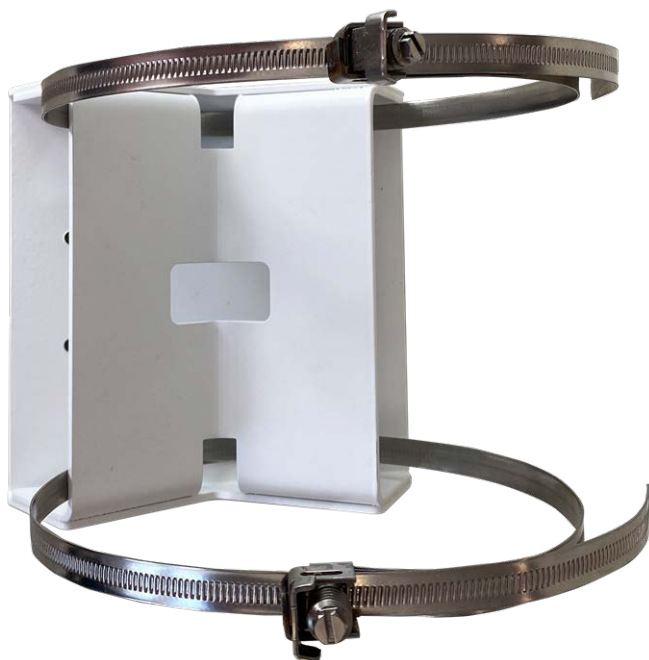

2. Tighten the stainless steel straps on the Pole Mount with a screwdriver. If necessary, the ends of the straps can be cut off.



Mounting

Mounting Options

3. Push the supplied network cable (Connector Box RJ45) through the upper hole ① or the yellow network cable (Connector Box LSA) through the lower hole ② of the mounting plate

Connector Box RJ45

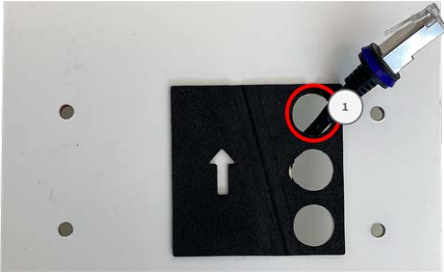

Fig. 14: Prepared for Connector Box RJ45

Connector Box LSA

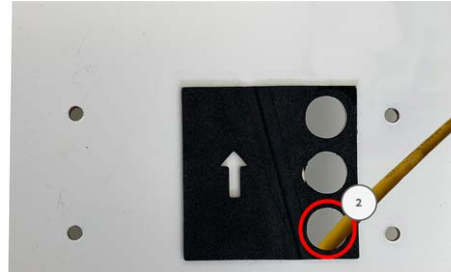

Fig. 15: Prepared for Connector Box LSA

Prepare the Mounting Plate when using the Connector Box RJ45

1. Connect the supplied patch cable 1.4 of the camera with the network connection of the building (see [Connecting the Camera to the Network](#), p. 70).

CAUTION! To prevent damage from condensation, using supplied patch cable 1.4 with sealing is mandatory.



2. The supplied network cable 1.4 has an integrated rubber sealing. Push the network cable through the top hole of the mounting plate, so that the funnel of the rubber plug ① points toward the camera.



Prepare the Mounting Plate when using the Connector Box LSA

1. Cut the tip of the upper white plug in the mounting plate ① and two steps of the lower white plug in the mounting plate ② :

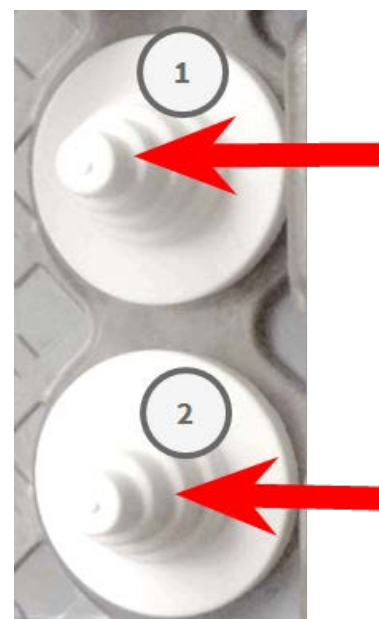

2. Rearrange the plugs in the mounting plate as required.

Mounting

Connecting the camera

3. Guide the ground wire through the upper cable plug ① and the network cable through the lower cable plug ② of the mounting plate as shown:

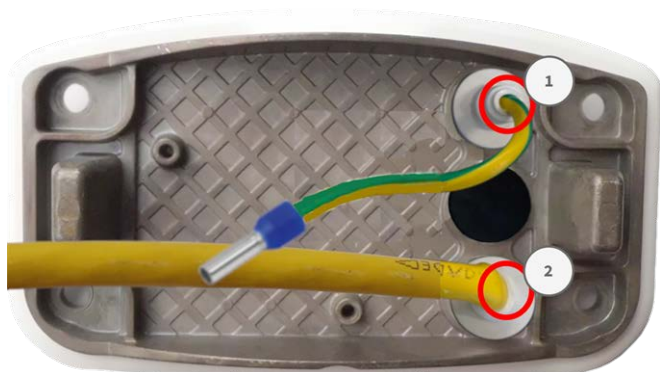

Installing the Mounting Plate

Place the mounting plate over the drilled holes (red circles in figures below) and use the four screws [M.12](#) with one washer [M.11](#) each and the TORX wrench TX20 [M.8](#) to mount the plate to the wall.

CAUTION! Install on flat surface only. Unevenness must not exceed 0.5 mm/0.02 in.

Connector Box RJ45



Fig. 16: Installed and ready for Connector Box RJ45

Connector Box LSA



Fig. 17: Installed and ready for Connector Box LSA

Connecting the camera

All connections to the camera (network, power supply, inputs/outputs) can be made on the camera's connector box. No further accessories are required for this. A PoE switch provides the camera's power supply.

Connecting the Camera to the Network

There are two ways to connect the camera to the network - with the Connector Box RJ45 or with the Connector Box LSA. A PoE switch provides the camera's power supply.

NOTE!

- An EN54-4 certified power supply must be used.
- The PoE switch must provide Class 4 according to PoE Plus (802.3at-2009) as well as the 100/1000 Mbps Ethernet interface of the camera.
- The maximum length of the network cable for remotely supplying power is 100 m (300 ft).



Fig. 18: Power supply using PoE switch according to PoE Plus (802.3at-2009).

Network connection with the Connector Box LSA

An Connector Box LSA is required to connect the camera to the network, to supply power via PoE and to protect the camera from electrical surge. The Connector Box LSA is not part of the scope of delivery (see [Delivered Parts and Dimensions](#)) and must be ordered in addition to the camera.



Fig. 19: Connector Box LSA with rubber plug black C.3 ① , rubber plug single-wire C.4 ② , USB plug ③ and two blue locks

Mounting

Connecting the camera

NOTE! You will need an LSA+/Krone tool for this procedure:



Fig. 20: LSA+/Krone tool

Prepare Mounting Plate and Cables

1. Cut the tip of the upper white plug in the mounting plate ① and two steps of the lower white plug in the mounting plate ② :

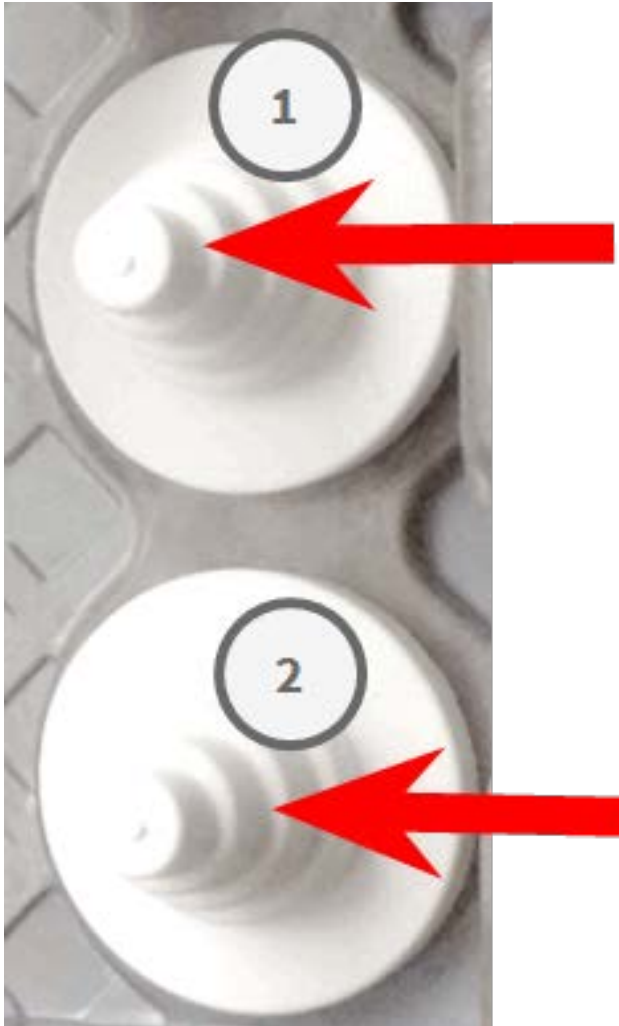

2. Rearrange the plugs in the mounting plate as required.

Mounting

Connecting the camera

3. Guide the ground wire through the upper cable plug and the network cable through the lower cable plug of the mounting plate as shown:



Fig. 21: Mounting plate with ground wire and network cable

4. Insert the network cable into the white rubber plug C.5:



Fig. 22: Network cable with rubber plug C.5

5. Remove the insulation from the network cable as shown below:

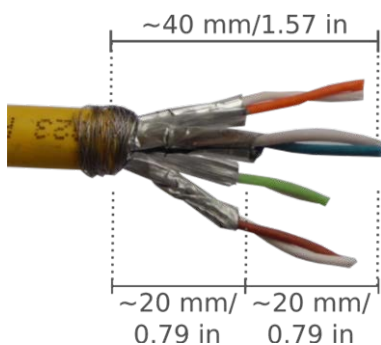

Attach the Network Cable to the Connector Box

1. Remove the black plug from the left-hand opening (plug ① in Connector Box LSA with rubber plug black C.3 ① , rubber plug single-wire C.4 ② , USB plug ③ and two blue locks, p. 71.

2. Insert the network cable into the connector box and make sure the rubber plug is properly seated all around the opening:



Fig. 23: Network cable inserted, plug properly seated

3. Insert the cable tie into the blue guides and tie down the network cable onto the copper-colored ground plate:

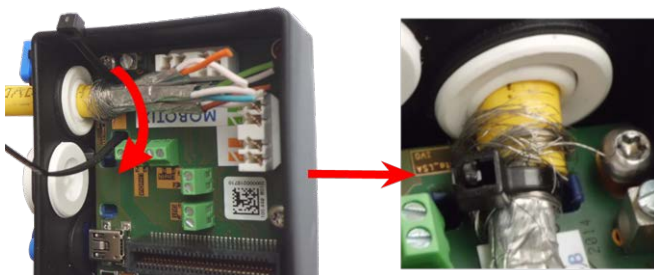

Fig. 24: Cable tie inserted beneath network cable

Mounting

Connecting the camera

4. Prepare the LSA+/Krone tool:

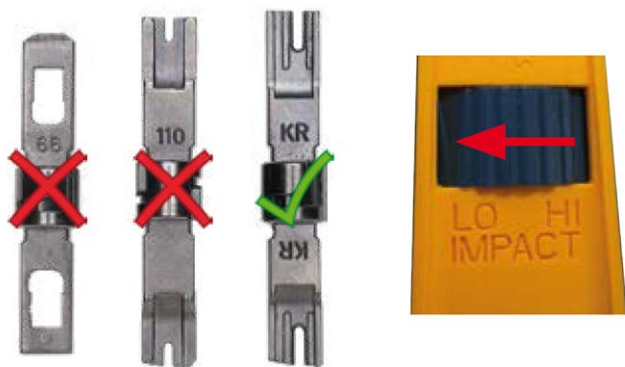

Fig. 25: LSA+/Krone tool set to LOW impact

CAUTION! Always use the proper LSA+/Krone blade and **set the tool to LOW impact.**

5. Connect the wires of the network cable using the LSA+/Krone tool according to the color code sticker inside the box:



Fig. 26: Network wires connected using LSA+/Krone tool

CAUTION! Remove all clipped wire ends to prevent short circuits!

6. Insert the ground wire into the white single-wire rubber plug C.4:

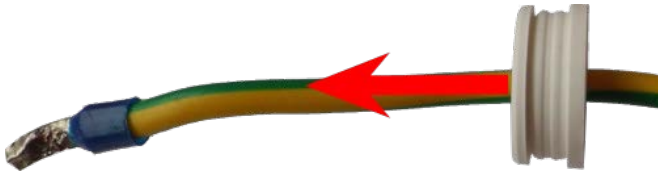

Fig. 27: Ground wire with single-wire rubber plug C.4

WARNING! For surge protection it is strongly recommended to attach the ground wire!

The maximum length of the grounding cable should be 1m to the ground potential (e.g. a potential equalization rail, a grounded pole or a grounding rod).

7. Insert the ground wire into the connector box and make sure the rubber plug is properly seated all around the opening:

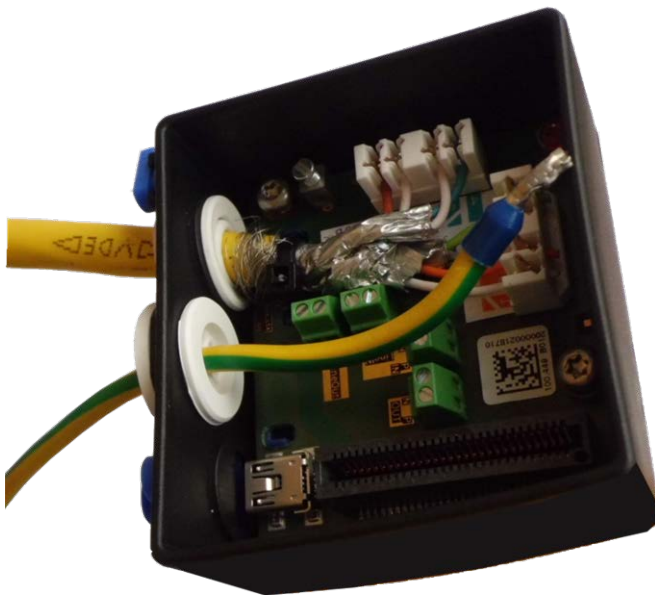

Fig. 28: Ground wire inserted, plug properly seated

Mounting

Connecting the camera

- Loosen the screw of the ground wire terminal, insert the ground wire and properly fasten the screw of the terminal:



Fig. 29: Ground wire connected to terminal

- Using the [TORX wrench TX10 M.9](#) and the two pre-mounted screws (highlighted red in the figure), fixate the connector box on the mounting plate:

NOTE! These are self-tapping screws. Make sure to properly tighten but do not over tighten them.

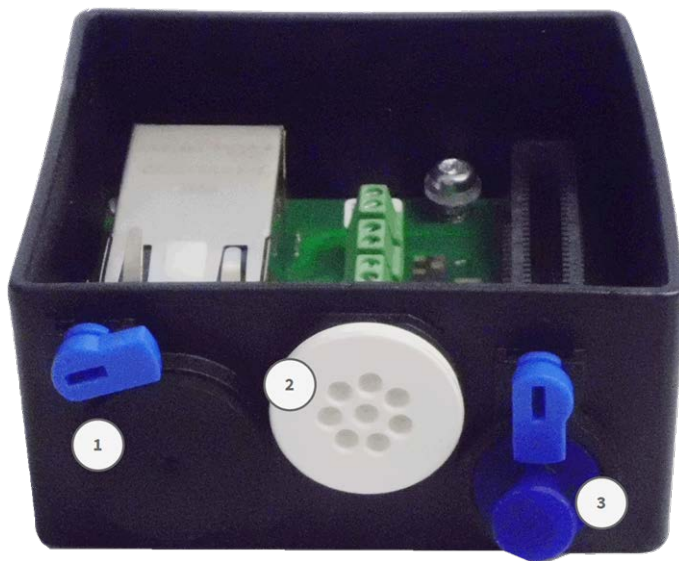

Fig. 30: Mount the Connector Box LSA (top view) using the two screws (highlighted red in the figure) on the mounting plate

CAUTION! Make sure that the connector box is properly fastened on the mounting plate as shown above. Failing to do so could damage the mainboard of the camera!

Continue with [Finishing the Installation of the Camera, p. 82](#).

Network connection with the Connector Box RJ45



1. Remove the black plug from the left-hand opening ① .
2. Plug the supplied network cable 1.4 into the network connector ① of the connector box.
3. Connect the other wires/cables as required (inputs/outputs, USB).
4. Secure the connector of the network cable by turning the blue lock clockwise as shown:

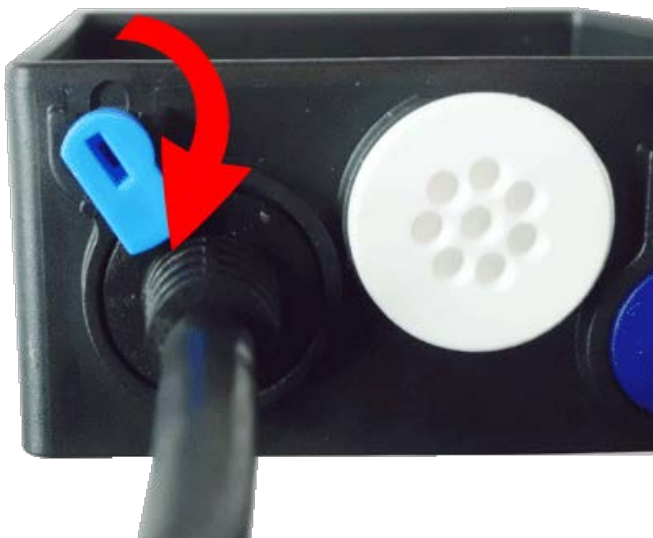

Mounting

Connecting the camera

- Using the [M.9](#) and the two pre-mounted screws (highlighted red in the figure), fixate the connector box on the mounting plate:

NOTE! These are self-tapping screws. Make sure to properly tighten but do not over tighten them.

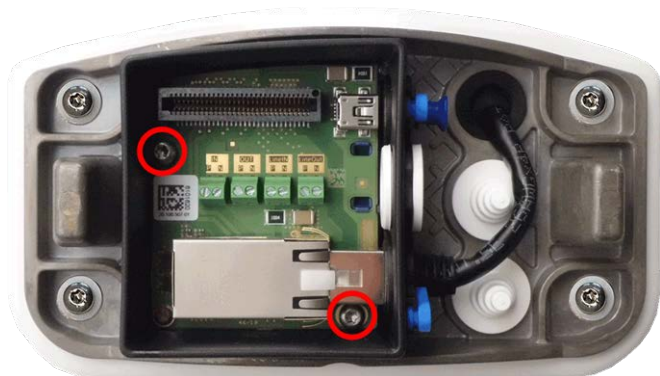

CAUTION! Make sure the connector box is properly fastened on the mounting plate as shown above. Failing to do so could damage the main board of the camera!

Continue with [Finishing the Installation of the Camera](#), p. 82.

Terminal Connectors

All connections to the camera (network, power supply, inputs/outputs) can be made directly on the connector box which part of the camera. A PoE switch provides the camera's power supply (see [Connecting the Camera to the Network](#), p. 70).

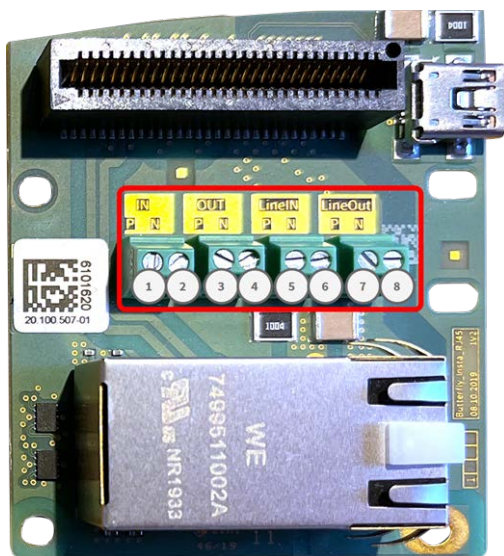

Terminal connectors Connector Box RJ45

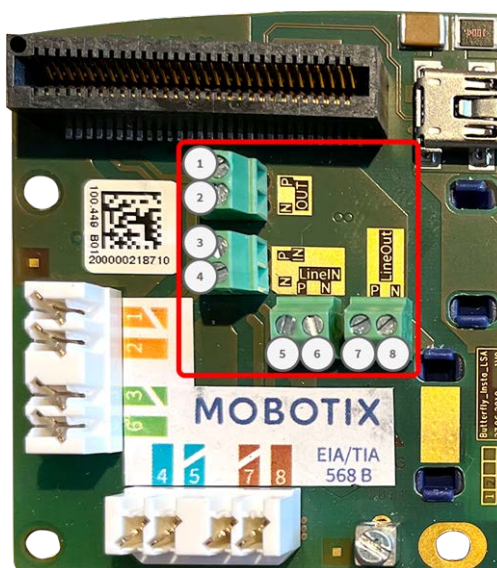

Terminal connectors Connector Box LSA

Allowed cable dimensions for cables connected to the PCB terminals

| | |
|-----------------------|---|
| AWG | 20 - 26 |
| Rigid | 0.14mm ² - 0.5mm ² |
| Flexible | 0.14mm ² - 0.5mm ² |
| Flexible with ferrule | 0.25mm ² - 0.34mm ² |

| Terminal | Remark |
|----------|--|
| Line In | Standard Line In: (0dB) Vrms=1V |
| Line Out | Headphones with 20mW @ 16 Ohm or 32 Ohm. Audio inputs as a Line Out function to 10k Ohm impedance of receiver. Audio level while connected to 10k Ohm equals -10dbV |
| IN | <ul style="list-style-type: none"> ▪ Contact Closure (no galvanic isolation necessary) or up to 50V AC/DC ▪ max. length for cables: 50m |
| OUT | <ul style="list-style-type: none"> ▪ requires pull-up resistor and external power supply (10mA / max. 50V DC - no AC) ▪ Output may be loaded with max. 50mA ▪ max. length for cables: depends on loop impedance of the connected cable. |

Example: switching an LED light using the P7 outputs

The outputs in the M73 Interface board are using an optocoupler with an open collector.

- The outputs will require the use of an external DC power supply up to 50 volts.
- The optimal output current of the optocouple output is around 10mA.
- The maximum limit of the output current is 50mA.
- This must be maintained by an external pull-up resistor.

NOTE! They outputs are not capable of dry connect closure or direct use with AC power

Mounting

Finishing the Installation of the Camera

The example shows a simple low voltage low current application such as switching an LED light using the P7 outputs.

The value of the pullup resistor depends on the forward voltage of the LED at the specific current you want to run through it.

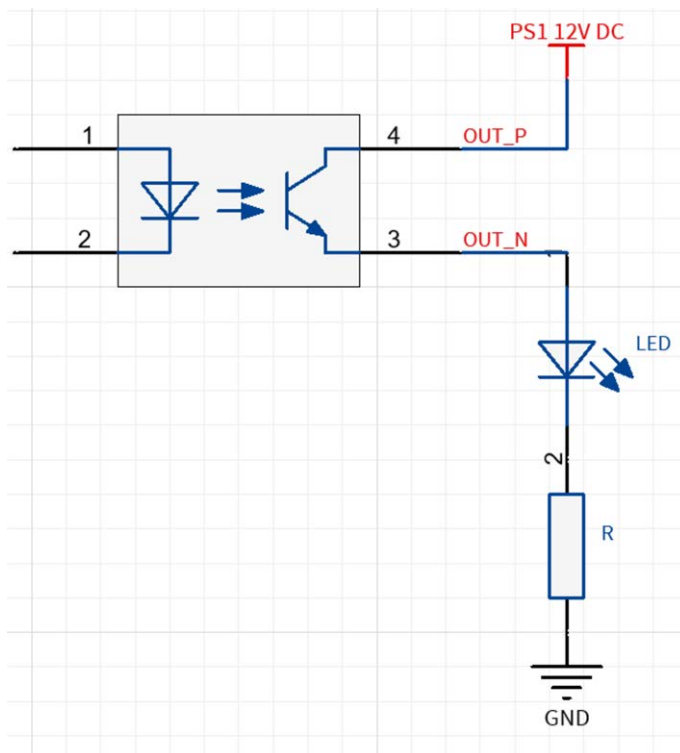

EXAMPLE:

- Amperage through LED: 10mA
- LED Forward Voltage @ 10mA: 2 V
- Power supply: 12V DC
- Resistor value = $(12V - 2V) / 10mA = 1 \text{ k}\Omega$

NOTE! For further examples take a look at the MOBOTIX Online Community: [https://-community.mobotix.com/](https://community.mobotix.com/)

Finishing the Installation of the Camera

To finish the installation of the MOBOTIX M73, the entire camera is mounted onto the mounting plate using the two lock screws. The connections of the camera are established automatically. The installation is finished by applying the remaining cover plugs to ensure the water-proofness of the housing.



You will need:

- Allen wrench 5 mm [M.6](#)
- 2 housing plugs silicone white [M.3](#)
- 2 caps for screw plastic white [M.15](#)

Mounting

Finishing the Installation of the Camera

1. Press the camera body onto the installed mounting plate, so that the wall sealing snugly seals off the camera body.



2. Tighten the two Allen screws using the Allen wrench M.6.



Mounting

Finishing the Installation of the Camera

3. Insert the two housing plugs in [M.3](#) firmly into the holes of the fastening screws.



4. Roughly point the camera into its direction of view.
5. Fixate the camera by tightening the two Allen screws (① , panning) and the two Allen screws (② , tilting) of the center pivot.

NOTE! To properly point the camera into the desired direction of view, read the section [Adjust the Camera](#).



6. Press the two covers m [M.15](#) onto the two Allen screws (② , upper figure) of the center pivot.



Operating the Camera

This section contains the following information:

| | |
|--|-----------|
| Getting Started | 90 |
| Boot Options of the Camera | 91 |
| Network Settings | 93 |
| Focusing the TELE 15° Sensor Module | 97 |

Getting Started

You can use the MOBOTIX M73 with any current browser – or with MxManagementCenter.

You can download MxManagementCenter free-of-charge from www.mobotix.com > [Support](#) > [Download Center](#) > [Software Downloads](#).

- 1. Connect the camera to the network.** The network cable will also provide power to the camera (see [Connecting the Camera to the Network](#), p. 70).
 - 1. Establish a connection to the camera and adjust the network settings if required:** By factory default, MOBOTIX cameras are booting as DHCP client with an additional fixed IP address in the 10.x.x.x range (e.g., 10.16.0.128). Local computer networks usually have IP addresses in the 172 or 192 ranges. Depending on whether a DHCP server is present on the local network or if the network has been set up to use fixed IP addresses, there are several possibilities for establishing a connection to the camera and to change its [Network Settings](#), p. 93:
 - **Network with dynamic IP addresses**

Using a browser: If you know the IP address that the DHCP server assigned to the camera, simply enter that address in the browser address bar to directly connect to the camera

Using MxManagementCenter: With MxManagementCenter, you can show and integrate the camera without having to know its current IP address.
 - **Network with static IP addresses**

In order to access the camera, it must have an IP address within the range of the local network. To set the camera's network parameters, you can use one of these methods:

Manually using a web browser: You may have to adjust the network settings of your computer.
 - **Automatically using MxManagementCenter:** The camera is displayed in MxManagementCenter although the IP address is not part of the local network, allowing you to reconfigure its settings.
 - 2. Configure camera:** You can use the user interface of the camera in a browser or in MxManagementCenter.

LED states

Camera LED on top of the camera body displays the following states by default:

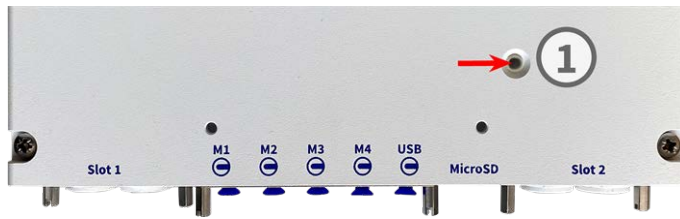

| LED status | Meaning |
|-----------------------|-------------------------------------|
| green steady on | normal operation |
| green steady flashing | technical error or misconfiguration |

Boot Options of the Camera

By default, the camera starts as DHCP client and automatically tries to get an IP address from a DHCP server. To start the camera in a mode different from the default mode, you can activate the boot menu of the camera.



NOTE! Pressing the key of the camera will let the camera announce the current IP address of the camera on the speaker (if a speaker is attached to the camera).

1. Prepare the camera:

- Disconnect the camera's power supply.
- Remove the allen screw ② using the Allen wrench 2.5 mm [M73: Scope of Delivery, p. 14](#). Take care not to loose the plastic washer.
- Take a suitable tool for operating the boot menu (e.g. the enclosed screwdriver [M73: Scope of Delivery, p. 14](#) or the Allen wrench 2.5 mm [M73: Scope of Delivery, p. 14](#).) **but do not use a paper clip or pointed objects!**
- Reconnect the power supply of the camera.

Operating the Camera

Boot Options of the Camera

2. **Activate the boot menu:** The red LED ① lights up 5 to 10 seconds after establishing the power supply and will stay on for 10 seconds. Press the key by inserting the tool into the hole ② . The camera enters the boot menu, ready for selecting one of the boot options. The LED will flash once. The flash signal will be repeated every second.

NOTE! The number of flashes corresponds to the current boot option.

3. **Switch the boot option:** Briefly press the key (< 1 sec). After the last boot option, the camera returns to the first boot option (LED flashes once).

| LED flashes | Boot Option | Meaning | Audio Confirmation* |
|-------------|----------------------|---|---------------------|
| 1x | ./• | This option is not supported on this camera model. | ./• |
| 2x | Factory Defaults | Starts the camera with factory defaults (factory default IP address, users and passwords will not be reset). | Boing |
| 3x | Automatic IP Address | Starts the camera as DHCP client and tries to obtain an IP address from a DHCP server. If a DHCP server cannot be found or no IP address can be obtained, the camera starts with its factory default address. | Boing-Boing |
| 4x | Recovery System | Starts the camera with the recovery system, e.g., in order to recover from a failed update of the camera software. | Alarm Sound |

*Only on cameras with audio option and installed speaker.

4. **Select a boot option:** Press the key longer (> 2 sec). The camera confirms the selection by flashing the LED rapidly for 3 seconds. After 20 sec, the camera will play a sound according to the table above.
5. Insert the Allen screws and the plastic washer using the Allen wrench 2.5 mm M.7 and take care not to over-tighten the screw.

NOTE! If you do not select a boot option, the camera will resume its normal boot process after a certain time.

CAUTION!

Note that you can restore specific parts of the camera configuration afterwards by using "Restore" to re-apply the settings still stored in the camera.

As opposed to resetting the camera using **Admin Menu > Reset configuration to factory defaults**, the user information will not be reset if the camera is booted using the factory defaults.

When starting the camera with DHCP support (option 2), make sure that the network has a properly functioning DHCP server. If this is not the case, the camera cannot obtain a valid IP address and will fall back to its last IP address.

You should also make sure that the cameras always get the same IP addresses by mapping the MAC addresses of the cameras to the desired IP addresses.

Network Settings

Once the camera has been connected to the network, you need to set up the MOBOTIX camera's network interface accordingly. This step involves setting up and checking the network parameters of the camera. If your network has an active DHCP server or if it is already running on a 10.x.x.x network with a 255.0.0.0 network mask) you do not need to change the camera's network parameters. You can directly access the camera. If neither your network nor your computer use an IP address in the 10.x.x.x network (e.g. a 192.168.x.x or 172.x.x.x network), you should follow one of the following methods for changing the camera's network parameters:

- Manual setup
- Automatic setup using MxManagementCenter

NOTE! For the following examples, we will use a camera with the factory IP address 10.16.0.99. Replace this IP address with the IP address of your camera. You will find this address on a small sticker on the camera. Make sure that the IP addresses used in the following examples are not used by any other devices on your network.

Windows

1. Open the Windows **Control Panel > Network and Internet > Network and Sharing Center > Change Adapter Settings > Ethernet.**

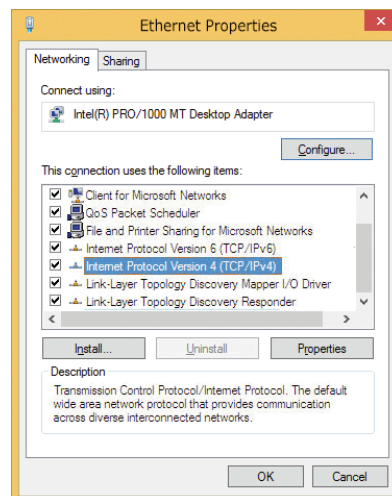

2. Right-click on the relevant network adapter and select **Properties.**
3. Open the properties of **Internet Protocol Version 4 (TCP/IPv4).**

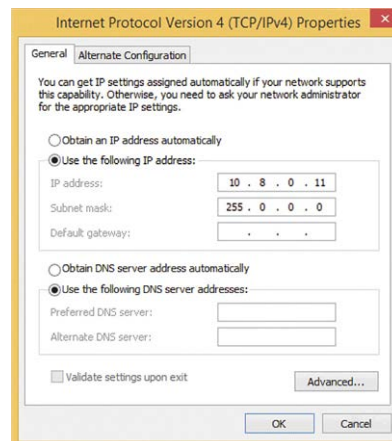

4. Activate **Use the following IP-address.** Enter an IP address in the 10.x.x.x range in this field (e.g. 10.16.0.11).
5. Click on **OK** to apply the settings.

Mac

1. Open **System Settings > Network**.

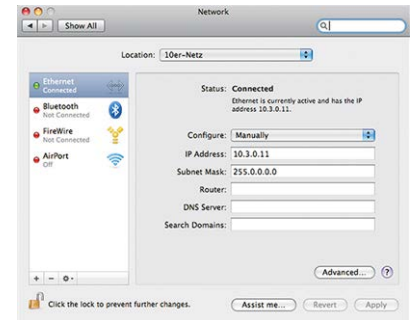

2. Click on **Ethernet** and in the **Configuration** field, select the *Manual* list entry and enter an IP address in the 10.x.x.x IP address range (e.g., 10.16.0.11).
3. Click on **Apply** to apply the settings.

Linux / Unix

1. Open a terminal as `root` user.
2. Enter the following command: `ifconfig eth0:1 10.16.0.11`.
3. The computer now has the additional IP address 10.16.0.11.

Network Settings on the Camera in the Webbrowser

1. Use a web browser to access the web interface of the MOBOTIX camera and enter the factory IP address (e.g. 10.16.0.99).

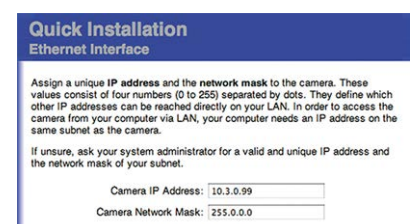

2. Click on the **Admin Menu** button in the user interface of the camera. The Quick Installation automatically starts after entering the access credentials of the admin user.

NOTE! Factory access credentials:

*User name:*admin

*Password:*meinsm

NOTE! You can also run the Quick Installation later on (**Admin Menu > Network Configuration > Quick Installation**; see Reference Manual).

3. Enter the network parameters of the camera in the course of the quick installation.

NOTE! You can also change the network parameters later on by running **Admin Menu > Network Configuration > Quick Installation**.

4. Reboot the camera to apply the network settings.

Network Settings on the Camera in MxMC

MxManagementCenter is a video management software for setting up and using the entire video surveillance system that provides a range of functions for different tasks and user groups. You can download the newest release of MxManagementCenter from the MOBOTIX website (www.mobotix.com > Support > Download Center > Software Downloads, MxManagementCenter section).

When starting MxManagementCenter for the first time, the configuration wizard opens and automatically starts searching for MOBOTIX cameras. The number of found cameras is shown as a counter next to the **Add Devices** icon. This number is updated automatically if the number of MOBOTIX cameras on the network has changed (i.e., by connecting new/disconnecting existing cameras).

1. Click on **Add Devices**. The cameras are displayed either in a list or as tiles. Use the List and Tile buttons to change the display mode.



The application automatically monitors and displays the operating status of all cameras using corresponding icons.

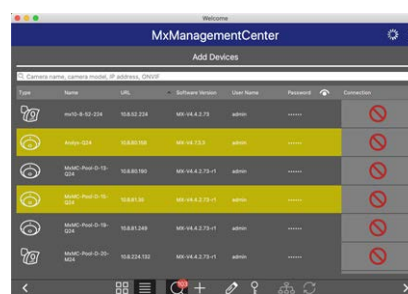

EXAMPLE:

- The camera is not in the same subnet as the computer.
- The user name and password of the camera are not known.

NOTE! Using the Bonjour service ([en.wikipedia.org/wiki/Bonjour_\(software\)](https://en.wikipedia.org/wiki/Bonjour_(software))), the application finds not only MOBOTIX cameras on the same subnet, but also in other subnets. Normally, you would not be able to establish any connection to cameras in a different network or subnet.

NOTE! This is the case, for example, if you are integrating cameras into a network without DHCP server (i.e. with fixed IP addresses) and the IP address range is different from the 10.x.x.x range supported by the cameras in addition to DHCP.

MxManagementCenter can automatically configure such a camera so that it is "integrated" into your existing network.

2. Select the camera you want to set up and click on **Edit Network Settings**  at the bottom of the program window. The **Change Network Settings for Selected Devices** dialog opens.



3. Enter the IP address and the subnet mask of the selected camera.

NOTE! The IP addresses of the other cameras are automatically incremented by 1.

4. Click on **Apply** to apply the settings.

NOTE! For more information on this feature, please read the MxManagementCenter online help or the Tutorial (see www.mobotix.com > Support > Download Center > Documentation > Brochures & Guides > Tutorials).

Focusing the TELE 15° Sensor Module

Once the camera has been mounted, the **TELE 15° sensor module** should be checked for proper sharpness. You will need the **lens wrench blue M.2** and the **module wrench gray M.1** that are part of the [M73: Scope of Delivery](#), p. 14.

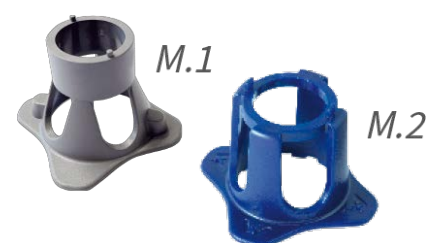

CAUTION! When adjusting the image focus or the field of view of the camera, always make sure that you can see the live image of the camera on your monitor.

To correct image sharpness, you can also make use of the visual **focusing aid** of the camera (see the **Camera Reference Manual**, section **The Live View of the MOBOTIX Camera**)

Operating the Camera

Focusing the TELE 15° Sensor Module

1. Show the live image of the camera on your monitor.
2. Insert the blue lens wrench into the notches of the sensor module.
3. Turn the wrench counter-clockwise until it stops



CAUTION! If the red security clips M.14 have not been installed, the sensor module will also rotate! If this happens, keep on turning until the sensor module stops in its position for removal.

4. Rotate the wrench to the left until the lens protection glass slides out of the sensor module.
5. Insert the gray module wrench (with its two small pins) into the holes of the lens and cautiously turn to the left and to the right. Adjust the image sharpness according to the live image on the computer monitor:

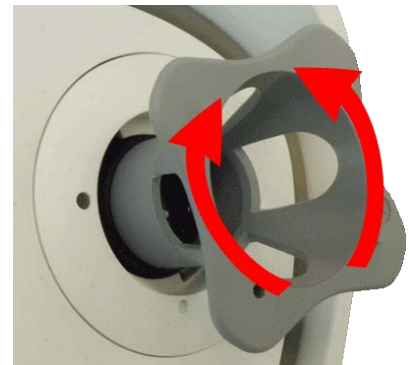

CAUTION! Never apply force when turning the lens and never screw the lens too deep into the thread since this could damage the image sensor! If in doubt, keep turning the lens counter-clockwise, then turn clockwise to focus the lens.

6. If required, clean the inside of the lens protection glass with a clean, lint-free cloth.



7. Set the lens protection glass onto the notches of the blue lens wrench and position the protection glass with its two prongs over the corresponding receptacles of the sensor module:

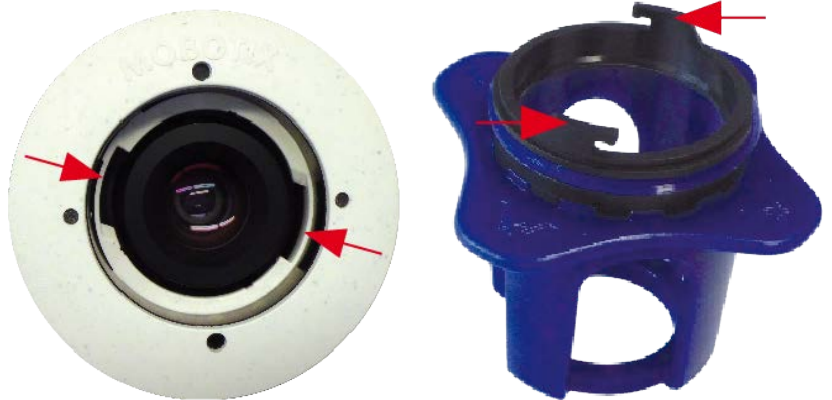

8. Using the lens wrench, press the lens protection glass firmly into the sensor module, until the glass fits flush with the sensor module housing.



9. Turn the lens protection glass clockwise using the blue lens wrench until it locks in place.
10. If required, clean the outside of the lens protection glass with a clean, lint-free cloth.

CAUTION! After adjusting the focus, make sure that the sensor module is aligned properly and that it is locked in place (use the gray module wrench to turn the sensor module clockwise until it stops).

Camera Software in the Browser

The integrated software of the MOBOTIX M73 features a multitude of functions, such as video motion detection, long-term recording, alarm messaging and video IP telephony. Especially remarkable are the AI-based analytics features and the possibility to install third-party apps on the camera. Thanks to the virtual PTZ features, you can continuously zoom into or out of the live image using either the mouse wheel or a joystick.

When recording images or video sequences, you can choose to store either the visible image area of the live image or the full sensor image. This also allows examining the parts of an image or video that had not been visible in the real-time image section on display at the time of the recording.

Instead of using a web browser, you can also download the free MxManagementCenter from the MOBOTIX website (www.mobotix.com > Support), which allows displaying multiple cameras on one monitor, allows for comfortably searching and evaluating the alarm video clips with audio and provides alerting features. For mobile iOS and Android devices, the free-of-charge MOBOTIX MOBOTIX LIVE App is available.

This section contains the following information:

| | |
|---|------------|
| Access the Camera in the Web Browser | 102 |
| Basic Settings | 102 |
| Configuring Sensor Modules | 103 |

Access the Camera in the Web Browser

Once the power and network connection of the MOBOTIX have been established, you can access the interface of the camera software in a web browser.

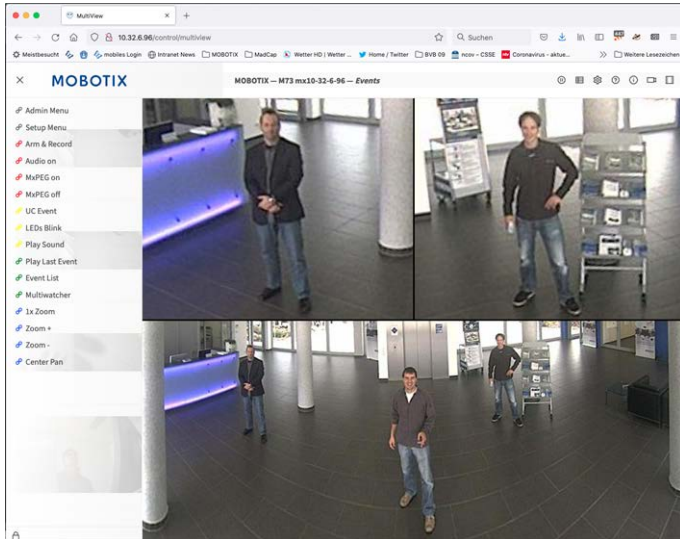

1. Enter the camera's IP address in the address field of a web browser.

NOTE! You can find the IP address of the camera, for example, in the camera housing or on the sticker on the packaging.

Basic Settings

Password for the Administration Menu: Accessing the administration area of the camera (Admin Menu button) in the browser is only possible after entering a user name and password.

- **Default user name:** admin
- **Default password:** meinsm

NOTE! You must change the password when logging in for the first time.

CAUTION! Make sure that you store information on user names and passwords in a secure place. If you lose the administrator password and cannot access the Administration menu, the password can only be reset at the factory. This service is subject to a service charge.

The Quick Installation wizard will appear automatically when accessing the Administration Menu for the first time. It provides an easy method to adjust the basic camera settings to the current application scenario. For

security reasons, it is highly recommended to change the default administrator password after the camera has been configured properly.

Administering the camera: You can modify the camera configuration in the Administration Menu or the Setup Menu:

- **Admin Menu:** This menu contains the basic configuration dialogs of the camera (e.g. passwords, interfaces, software update).
- **Setup Menu:** This menu contains the dialogs for configuring the image, event and recording parameters. Some of these settings can be changed using the corresponding Quick Controls in the Live screen.

NOTE! For more information, consult the Reference Manual of the camera.

Configuring Sensor Modules

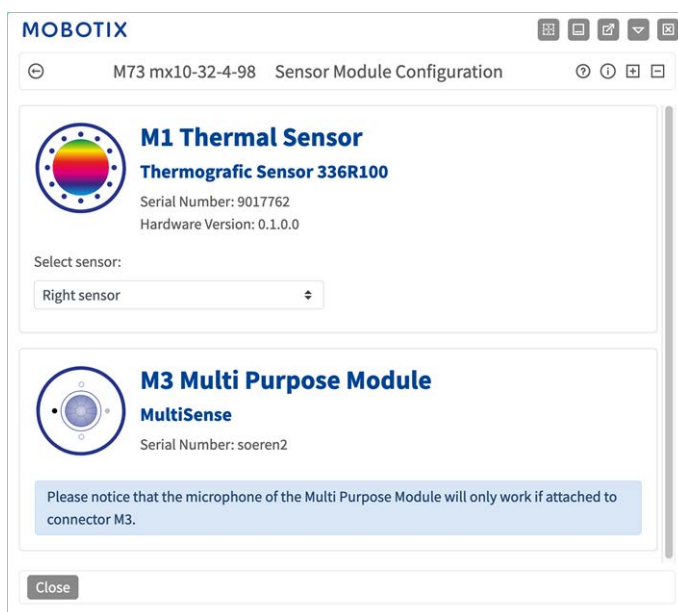

Using different combinations of sensor modules of the MOBOTIX M73 will have an influence on the display modes and configuration variants that are available.

An MOBOTIX M73 will automatically check and verify the installed sensor modules upon its first start and at every reboot thereafter (e.g., focal length, Day or Night variant). Please note the following:

- A Thermal Sensor Module (see [Installing a Thermal Front Plate, p. 50](#)), must be attached to connector **M1 (Thermal Sensor)**.
- If only one sensor module is attached, the camera will behave like a mono camera (i.e., there is no automatic Day/Night switching).

- If the modules are not exchanged within the first 12 operating hours, the camera will store the information of new sensor modules in the camera configuration.
- The camera will check the configuration on every reboot to see if the stored sensor modules are still present. If changes of the sensor module configuration have been detected (e.g., if a sensor module had to be replaced), the camera will show a corresponding message in the live image.

If required, the module configuration can be adjusted, e.g. you can define in which camera image (left or right) the sensor module should be displayed in a double image display.

1. Got to **Admin Menu > Hardware Configuration > Sensor Module Configuration**
2. Select the corresponding sensor module types

Do the **Sensor Module Configuration** in the following cases:

- **Switching the displayed camera images:** You want to show the left-hand camera image on the right (and vice versa), without having to physically swap the module connectors at the camera itself.

NOTE! Thermal sensor cannot be swapped, because they are pre-installed on a custom thermal front plate.

- **Exchanging sensor modules:** In this case, the MOBOTIX M73 will display a message box and will log a system message to inform you that sensor modules have been exchanged (see also [Installing the Sensor Modules to the Thermal Front Plate, p. 56](#)).
- **Adding/activating sensor modules:** You can activate modules that had been deactivated before.
- **Switching off/removing sensor modules:** If required, you can deactivate connected modules in this dialog.

For more information, consult the Reference Manual of the camera.

Maintenance

| | |
|--------------------------------------|-----|
| Opening the Camera Body | 106 |
| Replacing the microSD card | 109 |
| Cleaning the Camera and Lenses | 110 |

Opening the Camera Body

E. g. to replace the microSD card of the MOBOTIX M73, it is necessary to open the camera body.

The entire camera is mounted onto the mounting plate using the two lock screws.



You will need:

- Allen wrench 5 mm [Mounting Supplies: Scope of Delivery, p. 18](#)

Procedure

1. Remove the two housing rubber plugs [M.3](#) from the holes of the fastening screws.



Maintenance

Opening the Camera Body

2. Open the two allen screws using the Allen wrench [M.6](#).



3. Carefully pull the camera body off the mounting plate.



Replacing the microSD card

CAUTION! To remove, insert or exchange the microSD card, the camera must be disassembled.

Before removing the microSD card, deactivate the recording function and restart the camera. Non-observance can lead to data loss!

The microSD card must not be write-protected!

Do not touch the circuit board when exchanging the microSD card!

Step by step

1. **Deactivate storage:** If storage on microSD card is still activated deactivate it in the cameras web interface: **Admin Menu > Storage on external file server / flash media**, then reboot the camera .
2. **Open the camera body:** see [Opening the Camera Body](#), p. 106.



3. **Unlock the microSD card holder:** Carefully flip up the metal cover of microSD card (e.g. with a fingernail).

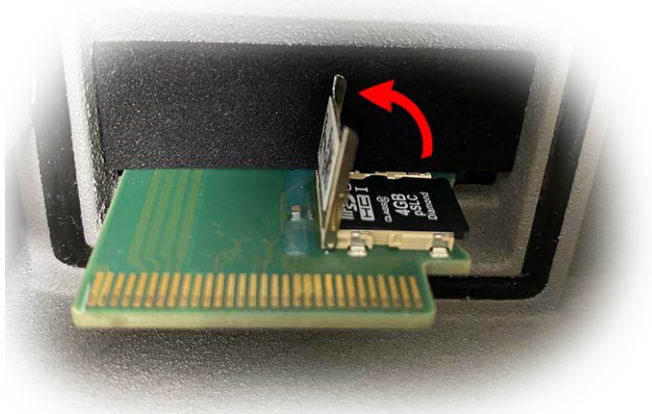

4. **Remove the microSD card**
5. **Insert microSD card:** Insert the new microSD card in the holder and close the metal cover with light pressure until it snaps in.

6. **Close the camera body:** (see [Finishing the Installation of the Camera](#), p. 82).
7. **Activate storage:** If the microSD card already is formatted with MxFFS has been inserted, storage can be activated in Admin Menu > Storage on External File Server/Flash Device. After rebooting the camera, recording is activated automatically. .

Cleaning the Camera and Lenses

Clean the camera housing using a mild alcohol-free detergent without abrasive particles.

To protect the lens protection glass, only use the supplied mounting supplies (see [Mounting Supplies: Scope of Delivery](#)).

Cleaning the lens protection glass

- Use the wide end of the gray module wrench [M.1](#) to remove/install the lens protection glass. The narrow side of the wrench is used to adjust the sharpness (focal length) of the tele lenses.
- You should clean the lens protection glasses and domes regularly using a clean, lint-free cotton cloth. If the dirt is more persistent, add a mild alcohol-free detergent without abrasive particles.
- Make sure you instruct cleaning personnel on how to clean the camera.

MOBOTIX

BeyondHumanVision

[EN_03/25](#)

MOBOTIX AG • Kaiserstrasse • D-67722 Langmeil • Tel.: +49 6302 9816-103 • sales@mobotix.com • www.mobotix.com

MOBOTIX is a trademark of MOBOTIX AG registered in the European Union, the U.S.A., and in other countries. Subject to change without notice. MOBOTIX do not assume any liability for technical or editorial errors or omissions contained herein. All rights reserved. © MOBOTIX AG 2019