



Technical Specifications

MOBOTIX ONE M1A-S (FIX & VARIO) - The one of a kind Video Security System

A robust maintenance-free German IP video system with outstanding design and high-quality components: glass fiber-reinforced, salt-water-resistant housing, high-end processors, image sensors for excellent quality, and cyber-secure firmware by MOBOTIX with integrated AI for top-level perimeter protection and intrusion detection.

- Comprehensive codec support: H.264, H.265, MxPEG+ and MJPEG
- Wide range of optics with application-oriented fixed and varifocal lenses
- 4K UHD resolution for crisp and detailed images at day and night
- Two integrated IR LED lights (near and long distance)
- Wide Dynamic Range (WDR) with up to 120 dB
- Internal DVR including 64 GB microSD card (up to 1 TB supported)
- Integrated MOBOTIX ActivitySensor with AI-based Object Recognition
- Robust in all environmental conditions: -40 to 65 °C, IP66, NEMA 4X and IK10
- 'Quick&Easy' installation with integrated bracket, concealed cabling and varifocal optics



BeyondHumanVision

MOBOTIX

Table of Contents

Order Information	2
Hardware	2
Image and Video Properties	5
General Software Features	6
Video Analysis	7
Video Management Software	7
Supported Lenses and Sensor	8
Order Information	8
Dimensions	10

Order Information

Name	MOBOTIX ONE M1A-S (FIX & VARIO)
------	---------------------------------

Order Code:	Mx-ONE-M1A-S-8XXXXX
-------------	---------------------

Hardware

Feature

Properties

Image sensor (color or B&W sensor)

up to 4K UHD 3840x2160, 16:9, 1/1,8"

Available Lenses

Varifocal Wide (4.3-9.3mm F/1.3/112-47°),

Varifocal Tele (11-29mm F/1.7/42-15°),
--

Fixed lens (see Supported Lenses and Sensor, p. 8)

Optical zoom

Yes (for varifocal models)

Light sensitivity

▪ Color sensor (day): 0,1 lx @ 1/60s; 0,005 lx @ 1s

▪ BW sensor (night): 0,02 lx @ 1/60s; 0,001 lx @ 1s

Feature	Properties
Exposure control	Manual and automatic mode 1 s to 1/16,000 s
IK protection class	IK10 (housing except lens)
IP / NEMA protection class	IP66 / NEMA 4X
Intended use	Not use in hazardous areas (Ex area)
Operating temperature range	-40 to 65 °C/-40 to 149 °F
Min. cold start temperature	-25 °C/-22 °F
Relative Humidity	95 % non-condensing
Internal DVR Storage	Internal microSD card (SDHC/SDXC), 64 GB out of the box, max. 1 TB.
I/Os	<p>INPUT</p> <ul style="list-style-type: none"> ▪ Contact Closure (no galvanic isolation necessary) or up to 50V AC/DC ▪ max. length for cables: 50m <p>OUTPUT</p> <ul style="list-style-type: none"> ▪ 2x Dry contact, form A (AC/DC, up to 50V / 60 W/ 2A)
Microphone/Speaker	<ul style="list-style-type: none"> ▪ Embedded ▪ Microphone Sensitivity: -35 +/-4 dB (0 dB = 1 V/pa, 1 kHz) ▪ 1 Embedded Speaker: 0.9 W at 8 Ohm ▪ 1 External Speaker optional
Integrated illumination	2 x embedded IR LEDs, 850nm, up to 30 m/100 ft (may be more depending on scene)
Shock detector (tamper detection)	Yes
Max. power consumption	max. 12,95 W (average may be significantly lower)
Electrical surge protection	Overvoltage Protection Box (not part of the scope of delivery)
PoE standard	PoE (802.3af-2003)/Class 3

Technical Specifications

Feature

Interfaces

Properties

- Ethernet 1000BaseT (RJ45 according to EIA/TIA-568B)
- USB 2.0 via USB-C connector
- 12-24VDC power supply
- Input / Output
- Ext. Speaker

Mounting Options

Wall-mountable (default)
Ceiling- or pole-mountable (with accessory, compatible with M26)

Dimensions
(height x width x depth)

222 x 131 x 238 mm

Weight

Approx. 0,973 kg/2,15 lbs

Housing

PBT-30GF

Standard accessories

1 Ethernet patch cable, 50 cm/19.7 in (installed)
1 SD card 64 GB (installed)
1 Important Safety Information
1 Sticker with EAN number of camera
1 Sticker with IP address of camera
1 Module wrench (yellow) *M1A-S FIX only
1 Sealing ring for VarioFlex and wall mounts)
5 Screw caps plastic white
1 5mm Allen wrench
4 Stainless steel washers Ø5.3 mm
4 Wood screws 4.5x60 mm
4 Dowels S8
1 Tweezers for replacing the SD card

Tiltability of camera

- Wall & pole mounted
Horizontal: 180°
Vertical: 110°
- Ceiling mounted
Horizontal: 360°
Vertical: 110°

Detailed technical documentation

www.mobotix.com > [Support](#) > [Download Center](#) > [Marketing & Documentation](#)

Feature	Properties
MTBF	100,000 hours
Certificates	EN 55032, EN 55035, EN 61000-6-1, EN 61000-6-2, EN 61000-6-3, EN 61000-6-4, EN 62368-1, EN 63000, AS/NZS CISPR32, 47 CFR Part 15b
Protocols	DHCP (client and server), DNS, ICMP, IGMP v3, IPv4, IPv6, HTTP, HTTPS, FTP, FTPS, NFS, NTP (client and server), MQTT, RTP, RTCP, RTSP, SFTP, SIP (client and server), SMB/CIFS, SNMP, SMTP, SSL/TLS 1.3, TCP, UDP, VLAN, VPN, Zeroconf/mDNS
Manufacturer warranty	5 years

Image and Video Properties

Feature	Properties
Available video codecs	<ul style="list-style-type: none"> ▪ H.264, H.265 ▪ MxPEG+ ▪ MJPEG
Image resolutions	VGA 640x360, XGA 1024x576, HD 1280x720, FullHD 1920x1080, QHD 2560x1440, 4K UHD 3840x2160
Max. image resolution	4K UHD 3840x2160 (8MP)
Multi streaming	H.264, H.265
Multicast stream via RTSP	Yes
Max. frame rate	MxPEG: 20@4K, H.264: 30@4K, H.265: 30@4K

General Software Features

Feature	Properties
Software features	<ul style="list-style-type: none">▪ H.264, H.265 Multistreaming▪ Multicast stream via RTSP▪ Digital pan, tilt, zoom/vPTZ (up to 8x zoom)▪ Genetec protocol integration▪ Programmable exposure zones▪ Snapshot recording (pre/post-alarm images)▪ Continuous recording▪ Event recording▪ Time-controlled flexible event logic▪ Weekly schedules for recordings and actions▪ Event video and image transfer via FTP and email▪ Playback and QuadView via web browser▪ Animated logos on the image▪ Master/Slave functionality▪ Privacy zone scheduling▪ Remote alarm notification (network message)▪ Programming interface (HTTP-API)▪ MxMessageSystem
ONVIF compatibility	Profile G, S, T, (M with later firmware release)
Master/Slave functionality	Yes
Remote alarm notification	email, network message (HTTP/HTTPS), SNMP, MxMessageSystem, MQTT
DVR/image storage management	<ul style="list-style-type: none">▪ On internal microSD card▪ On external USB and NAS devices▪ Different streams for live image and recording▪ MxPEG+ only▪ MxFFS with buffered archive, pre- and post-alarm images, storage monitoring with error reporting

Feature	Properties
Camera and data security	User and group management, SSL connections, IP-based access control, IEEE 802.1X, intrusion detection, digital image signature
Digitally signed firmware	Yes (to prevent firmware file tampering)

Video Analysis

Feature	Properties
Video motion detection	Yes
MxActivitySensor	Version 1.0, 2.1, 3.0 (incl. AI Motion and Loitering Detection)
MOBOTIX App support	Yes with a later FW release

Video Management Software

Feature	Properties
MOBOTIX HUB	Yes www.mobotix.com > Support > Download Center > Software Downloads
MxManagementCenter	Yes (latest version recommended) www.mobotix.com > Support > Download Center > Software Downloads
MOBOTIX Cloud	Streaming & Events supported
MOBOTIX LIVE App	Yes (available in Google Play Store (Android) and Apple App Store (iOS)).
3rd Party VMS Software	see ONVIF Profile S, T and G specification

Supported Lenses and Sensor

Lens	Sensor
Fixed lens (120°, 95°, 60°, 45°, 30°, 15°)	4K Sensor as D/N IR cut / Night Version
Varifocal Tele Lens 42°-15°	4K Sensor as D/N IR cut / Night Version
Varifocal Wide Lens 112°-47°	4K Sensor as D/N IR cut / Night Version

Order Information

Varifocals

Mx-ONE-M1A-S-8DNTELE	M1A-S with 4K DN Tele Varifocal (Day/Night), 42° - 15°
Mx-ONE-M1A-S-8DNWIDE	M1A-S with 4K DN Wide Varifocal (Day/Night), 112° - 47,5°

Fix Lenses

Mx-ONE-M1A-S-8DN040	M1A-S with 4K DN040 (Day/Night), 120°x60°
Mx-ONE-M1A-S-8DN050	M1A-S with 4K DN050 (Day/Night), 95°x50°
Mx-ONE-M1A-S-8DN080	M1A-S with 4K DN080 (Day/Night), 60°x33°
Mx-ONE-M1A-S-8DN100	M1A-S with 4K DN100 (Day/Night), 45°x25°
Mx-ONE-M1A-S-8DN150	M1A-S with 4K DN150 (Day/Night), 30°x17°
Mx-ONE-M1A-S-8DN280	M1A-S with 4K DN280 (Day/Night), 15°x8,5°
Mx-ONE-M1A-S-8N040	M1A-S N with 4K N040 (Night) 120°
Mx-ONE-M1A-S-8N050	M1A-S N with 4K N050 (Night), 95°
Mx-ONE-M1A-S-8N080	M1A-S N with 4K N080 (Night), 60°
Mx-ONE-M1A-S-8N100	M1A-S N with 4K N100 (Night), 45°
Mx-ONE-M1A-S-8N150	M1A-S N with 4K N150 (Night), 30°
Mx-ONE-M1A-S-8N280	M1A-S N with 4K N280 (Night), 15°

Mounts

Mx-MH-SecureFlex-ESWS (TBC)	Pole mount for M1x, M2x, M1A-S
MX-M-CM-M1	Ceiling Mount

Dimensions

NOTE! Download the drilling template from the section or on the MOBOTIX website: www.mobotix.com > [Support](#) > [Download Center](#) > [Marketing & Documentation](#) > [Drilling Templates](#).

CAUTION! Always print or copy the drilling template at 100% of the original size!

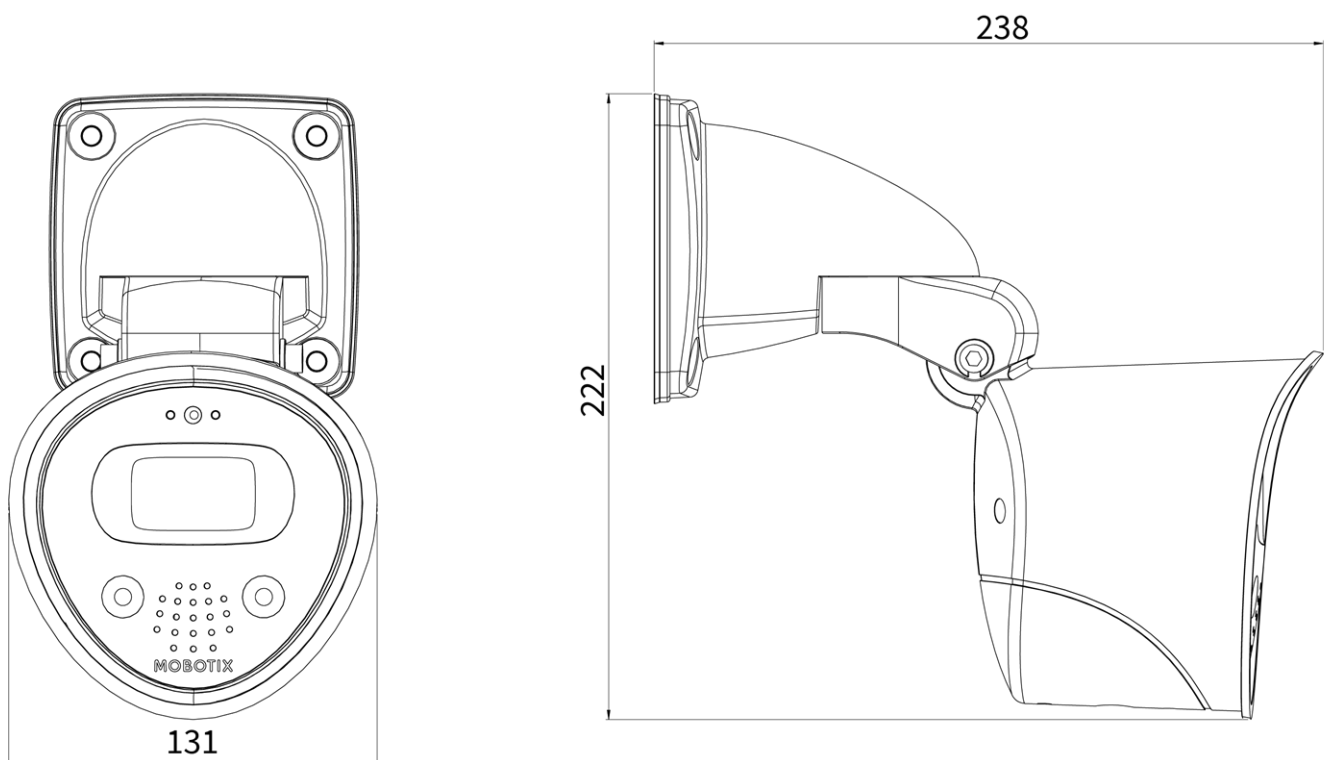

Fig. 1: MOBOTIX ONE M1A-S (FIX & VARIO): All measurements in mm

MOBOTIX

BeyondHumanVision

[EN_01/25](#)

MOBOTIX AG • Kaiserstrasse • D-67722 Langmeil • Tel.: +49 6302 9816-103 • sales@mobotix.com • www.mobotix.com

MOBOTIX is a trademark of MOBOTIX AG registered in the European Union, the U.S.A., and in other countries. Subject to change without notice. MOBOTIX do not assume any liability for technical or editorial errors or omissions contained herein. All rights reserved. © MOBOTIX AG 2019