

# User Guide

## MOBOTIX MOVE Vandal Multisensor PTZ Combo 20MP Video Analytics Camera

© 2025 MOBOTIX AG



BeyondHumanVision

**MOBOTIX** MOVE

# Table of Contents

---

<b>Table of Contents</b> .....	<b>2</b>
<b>Before You Start</b> .....	<b>9</b>
Support .....	10
MOBOTIX Support .....	10
MOBOTIX eCampus .....	10
MOBOTIX Community .....	10
Safety Notes .....	11
Legal Notes .....	12
Instructions for use .....	13
When using the machine via the Internet .....	13
For long-term stable performance .....	13
If the power supply is turned off and on repeatedly, failure of the equipment may result; handle with care .....	13
When an error is detected, restart automatically. ....	14
Operation status detection function .....	14
CMOS sensor .....	14
For maintenance .....	14
Cleaning the dome cover .....	15
Consumables .....	15
Motor operation noise .....	15
About the AVC Patent Portfolio License .....	15
In the event the camera is transferred or disposed of .....	16
Connection to the Internet .....	16
Protection of personal information .....	16
HEVC (High Efficiency Video Coding) Patent .....	16
About Routers .....	17
Time Setting .....	17
<b>Overview</b> .....	<b>19</b>
Features .....	20
Package Contents .....	21
Dimensions .....	22
Accessories for Multisensor Cameras .....	23
Dimensions .....	24

---

Accessories for All Cameras .....	25
Further Reading .....	29
<b>Installation .....</b>	<b>31</b>
General Remarks .....	32
Camera Installation .....	32
<b>Operation .....</b>	<b>33</b>
Initial Settings .....	34
Administrator registration .....	34
Language/time and date .....	37
Screen settings .....	39
Set position .....	40
Viewing images from a PC .....	40
IP Address or DDNS Name? .....	40
View camera images .....	42
About live image pages .....	44
Viewing images from smart phones/tablet computers .....	57
IP Address or DDNS Name? .....	57
Viewing images from smart phones .....	58
Viewing images from tablet computers .....	66
Manually saving images on the SD Card .....	78
Operation when alarm is generated .....	79
Alarm type .....	79
Operation when alarm is generated .....	80
Display the log list .....	81
① Recording period .....	82
② Recording stream .....	83
③ Event .....	83
④ Recording time .....	83
⑤ Search button .....	84
⑥ Log list .....	84
Playing back images/video streams from the SD card .....	85
Playing back JPEG images .....	87
Playing back videos .....	89
<b>Basic settings .....</b>	<b>93</b>
The Configuration panel .....	94
Accessing the configuration panel .....	94
Editing the configuration .....	94
Setting the Panel Screen .....	95

---

## Table of Contents

---

Basic settings .....	96
Basic .....	97
Date and time and Characters on screen .....	97
Stream settings .....	98
Common .....	98
Stream .....	98
JPEG .....	99
Image quality settings .....	100
Image quality .....	100
Zoom settings (EX zoom) .....	101
Zoom .....	102
Audio settings .....	102
Audio .....	102
Alarm settings .....	103
Alarm .....	103
Switching to Detailed settings for displayed images .....	104
<b>Detailed settings .....</b>	<b>107</b>
About network security .....	108
Security function of the unit .....	108
The camera settings menu .....	109
Accessing the camera settings menu .....	109
Editing the camera settings .....	111
The Settings menu buttons .....	112
Function extension software .....	115
Using the AI-VMD function extension software .....	115
Installing, uninstalling, and upgrading extension software .....	116
Scheduling extended software operation .....	121
Checking the Control log of function extension software .....	123
Using Easy Setup .....	124
Configuring event actions .....	124
Basic setup of the camera .....	147
Basic settings .....	147
SD card options .....	154
Detecting tampering .....	165
Configuring overlay images .....	167
Configuring image and audio options for recordings .....	172
Setting image modes .....	172
Configuring JPEG image options .....	174

---

Configuring streaming options .....	177
Configuring image quality .....	187
Configuring audio options .....	224
Setting the PTZ options .....	227
Configuring PTZ camera functions .....	227
Setting PTZ positions .....	232
Configuring auto tracking .....	249
Setting up auto track alarms .....	255
Working with alarms .....	258
Configuring alarms .....	258
Configuring output terminal alarms .....	262
Using alarms to change the AUX name .....	264
Using alarms to execute camera actions .....	265
Configuring motion detection using VMD areas .....	271
Configuring screen change detection using SCD areas .....	281
Configuring audio detection .....	285
Configuring alarm notifications .....	287
Managing users .....	293
Configuring user authentication .....	293
Configuring host authentication .....	296
Setting a prioritized stream .....	297
Configuring IEEE 802.1X .....	298
Setting up data encryption .....	304
Configuring the network .....	309
Basic network settings .....	309
Advanced network settings .....	314
MxMessageSystem settings .....	341
Using schedules .....	345
Defining schedules .....	346
Deleting schedules .....	350
Camera maintenance .....	350
Checking the system log entries .....	350
Upgrading the software .....	351
Checking the camera status .....	354
Initializing/restarting the camera .....	357
Backing up/restoring configuration data and logs .....	358

---

## Table of Contents

---

Support .....	360
<b>Technical Support Information .....</b>	<b>361</b>
Technical Specifications .....	362
DORI Specifications .....	367
Multisensor Cameras .....	368
PTZ Camera .....	368
Turret Cameras .....	368
<b>Appendix .....</b>	<b>369</b>
AI-VMD for object detection and counting .....	370
Introduction .....	370
Before using this product .....	374
Configuring AI-VMD .....	375
Demo screen .....	397
Using AI-VMD .....	400
Open Source Software Licenses .....	402
System log explanations .....	405
SMTP .....	405
Visual.Net .....	405
Dynamic DNS update .....	406
NTP .....	406
HTTPS .....	407
MQTT .....	407
Login .....	407
Unique alarm notification .....	408
HTTP alarm notification .....	408
SD card security .....	409
Firmware upgrade .....	409
Installation status .....	409
FTP/SFTP .....	410
Troubleshooting .....	411
Cannot access camera from web browser .....	411
Cannot access camera from Internet .....	412
High latency when displaying images .....	413
Camera cannot be accessed from mobile or tablet terminal .....	414
No image .....	414
Blurred image .....	414
Image not focused after booting .....	414
Image is not updated .....	415

Images are dark .....	415
Images are too bright .....	415
Images are flickering .....	415
Images not saved on SD card or read/write errors .....	416
Cannot use voice transmission .....	416
No audio from network disk recorders or PC software .....	416
Live image not displayed .....	417
Camera icon not displayed in Windows Network .....	417
Image not updated or displayed .....	417
H.265/H.264 stream is choppy .....	417
Back button of Web browser does not show correct screen .....	417
"Access is concentrated. Run later." message on live page .....	418
Browser messages incomplete/broken .....	418
SD card folder structure .....	419
Folder structure of the PTZ camera .....	419
Folder structure of the Multisensor Camera .....	420
Minimum hardware requirements for computers .....	421





## Before You Start

This section contains the following information:

<b>Support</b> .....	<b>10</b>
<b>Safety Notes</b> .....	<b>11</b>
<b>Legal Notes</b> .....	<b>12</b>
<b>Instructions for use</b> .....	<b>13</b>

# Support

## MOBOTIX Support

If you need technical support, please contact your MOBOTIX dealer. If your dealer cannot help you, he will contact the support channel to get an answer for you as quickly as possible.

If you have internet access, you can open the MOBOTIX help desk to find additional information and software updates.

Please visit [www.mobotix.com](http://www.mobotix.com) > [Support](#) > [Help Desk](#).



## MOBOTIX eCampus

The MOBOTIX eCampus is a complete e-learning platform. It lets you decide when and where you want to view and process your training seminar content. Simply open the site in your browser and select the desired training seminar.

Please visit [www.mobotix.com/ecampus-mobotix](http://www.mobotix.com/ecampus-mobotix).



## MOBOTIX Community

The MOBOTIX community is another valuable source of information. MOBOTIX staff and other users are sharing their information, and so can you.

Please visit [community.mobotix.com](http://community.mobotix.com).



## Safety Notes

- This camera must be installed by qualified personnel and the installation should conform to all local codes.
- This product must not be used in locations exposed to the dangers of explosion.
- Do not use this product in a dusty environment.
- Protect this product from moisture or water entering the housing.
- Install this product as outlined in this document. A faulty installation can damage the product!
- Do not replace batteries of the camera. If a battery is replaced by an incorrect type, the battery can explode.
- This equipment is not suitable for use in locations where children are likely to be present.
- External power supplies must comply with the Limited Power Source (LPS) requirements and share the same power specifications with the camera.
- When using a power adapter, the power cord shall be connected to a socket-outlet with proper ground connection.
- Do not use this product in the following locations:
  - Locations where a chemical agent is used (e.g. swimming pools).
  - Locations subject to moisture or oil smoke (e.g. kitchens).
  - Locations with an atmosphere containing flammable substances.
  - Locations subject to high levels of magnetic or electromagnetic fields (e.g. X-rays, strong radio waves).
  - Locations near coasts with high levels of atmospheric salt or other corrosive substances (e.g. coast lines, hot springs, volcanic gases, etc.).
  - Locations subject to vibrations (e.g. vehicles, marine vessels, above production lines).
  - Locations subject to high levels of condensation (e.g. near the outdoor unit of an air conditioner).
  - Locations near rubber products containing sulfur (e.g. packaging, rubber feet, etc.).
- To comply with the requirements of EN 50130-4 regarding the power supply of alarm systems for 24/7 operation, it is highly recommended to use an uninterruptible power supply (UPS) for backing up the power supply of this product.

**NOTE!** Observe the [MOBOTIX MOVE Installation Hints](#) document to ensure optimum performance of the camera features.

# Legal Notes

## Legal Aspects of Video and Sound Recording

You must comply with all data protection regulations for video and sound monitoring when using MOBOTIX AG products. Depending on national laws and the installation location of the cameras, the recording of video and sound data may be subject to special documentation or it may be prohibited. All users of MOBOTIX products are therefore required to familiarize themselves with all applicable regulations and to comply with these laws. MOBOTIX AG is not liable for any illegal use of its products.

## Declaration of Conformity

The products of MOBOTIX AG are certified according to the applicable regulations of the EC and other countries. You can find the declarations of conformity for the products of MOBOTIX AG on [www.mobotix.com](http://www.mobotix.com) under **Support > Download Center > Marketing & Documentation > Certificates & Declarations of Conformity**.

## RoHS Declaration

The products of MOBOTIX AG are in full compliance with European Unions Restrictions of the Use of Certain Hazardous Substances in Electrical and Electronic Equipment (RoHS Directive 2011/65/EC) as far as they are subject to these regulations (for the RoHS Declaration of MOBOTIX, please see [www.mobotix.com](http://www.mobotix.com), **Support > Download Center > Marketing & Documentation > Brochures & Guides > Certificates**).

## Disposal

Electrical and electronic products contain many valuable materials. For this reason, we recommend that you dispose of MOBOTIX products at the end of their service life in accordance with all legal requirements and regulations (or deposit these products at a municipal collection center). MOBOTIX products must not be disposed of in household waste! If the product contains a battery, please dispose of the battery separately (the corresponding product manuals contain specific directions if the product contains a battery).

## Disclaimer

MOBOTIX AG does not assume any responsibility for damages, which are the result of improper use or failure to comply to the manuals or the applicable rules and regulations. Our General Terms and Conditions apply. You can download the current version of the **General Terms and Conditions** from our website at [www.mobotix.com](http://www.mobotix.com) by clicking on the corresponding link at the bottom of every page.

It is the User's responsibility to comply with all applicable local, state, national and foreign laws, rules, treaties and regulations in connection with the use of the Software and Product, including those related to data privacy, the Health Insurance Portability and Accountability Act of 1996 (HIPPA), international communications and the transmission of technical or personal data.

## Instructions for use

### When using the machine via the Internet

In order to prevent unintended access by third parties, keep the user authentication setting **On**. Change the password for accessing the camera periodically. Refer to the following for how to change.

→[Configuring user authentication, p. 293](#)

### For long-term stable performance

Do not use the product in a place with high temperature and high humidity for a long time.

Degradation of parts shortens the life of the product.

Improve the heat dissipation in the installation area and prevent direct exposure to heat such as heating.

### **If the power supply is turned off and on repeatedly, failure of the equipment may result; handle with care**

Do not drop or apply strong shock or vibration. Failure to heed this warning may result in failure. Do not touch the dome cover directly.

If dirty, image quality may deteriorate.

## When an error is detected, restart automatically.

The camera automatically restarts when an error is detected for some reason. When restarting, the operation cannot be performed for approximately 2 minutes as it was when the power was turned on.

## Operation status detection function

If abnormal operation is continued for 30 seconds or longer due to external noise or the like during operation, the camera will restart automatically and return to normal operation. The restart operation is the same as when the power is turned on. However, if the restart occurs frequently, external noise may be generated frequently in the installation environment of this equipment.

Consult your dealer as soon as possible, as this may cause a malfunction. Periodic distortion of the screen

If the camera is installed in a place where it vibrates in small increments (for example, close to a vibrating device), the screen may periodically become distorted to extend and contract lengthwise. This is a characteristic phenomenon that occurs when the CMOS sensor is used for the image pickup device. It is caused by periodic movement of the screen and the timing of reading out the image from the image sensor, and it is not an error in the camera. Reassess the installation condition and ensure the stability of the camera body to alleviate the problem.

We shall not be liable for any loss of, or direct or indirect damage caused by, any compensation, recording, or editing of the contents that could not be correctly recorded or edited due to a defect in the machine or the microSD card. The same shall apply to the case of repair of the camera.

## CMOS sensor

If a portion of the screen is bright, such as spot light, the color filter inside the CMOS sensor may deteriorate, resulting in discoloration. When the direction of fixed monitoring is changed, spot light on the previous screen will change color and remain.

When you shoot a fast-moving object, you may see the object bending diagonally across the screen.

## For maintenance

Turn off the power before starting operation. Doing so may result in injury.

Do not apply or use organic solvents such as benzene and thinner. The case may become discolored. Follow the precautionary statement when using chemical foil.

Do not loosen or remove the screws not specified in the operation manual.

## PTZ camera

After maintenance, the camera may have changed its orientation. Be sure to refresh the position or restart the machine. For details, please refer to the following.

→[Initializing/restarting the camera, p. 357](#)

## Cleaning the dome cover

If the dome cover is dirty, clean it with a lens cleaning paper (for cleaning cameras and eyeglasses).

Picture shaking correction function

Depending on the installation location, the shaking correction function may not be sufficiently effective.

## Consumables

In some models, consumables are included in parts.

## Motor operation noise

Depending on the operation speed of the pan or tilt, the operation sound may become louder. If you are concerned about the operation sound from the auto pan, you can improve it by lowering the set speed of the auto pan.

## About the AVC Patent Portfolio License

This product is licensed under the AVC Patent Portfolio License and is not licensed except for your personal and non-commercial use of the following:

Image information shall be recorded in accordance with the AVC standard (hereinafter referred to as AVC video).

Playing AVC videos recorded by consumers engaged in personal activities or AVC videos obtained from licensed providers. See the MPEG LA, LLC home page (<https://www.mpegla.com/>) for more information.

Position Refresh **PTZ camera**

If the camera is used for a long time, the preset position may be misaligned. It is recommended to set position refresh using the schedule function and periodically correct camera misalignment. Please refer to the table below for the setting.

→[Using schedules, p. 345](#)

## **In the event the camera is transferred or disposed of**

The contents of the information recorded on the camera and the contents of the information recorded on the storage media used with the camera may correspond to "personal information." When handing over the unit to a third party for disposal, transfer, repair, etc., pay careful attention to the handling. When discarding the storage media, it is recommended to physically destroy the data after deleting it with a PC, etc.

## **Connection to the Internet**

The camera cannot be connected directly to communication lines (including public wireless LANs) of telecommunications carriers (mobile carriers, fixed carriers, Internet providers, etc.). When connecting the camera to the Internet, be sure to connect via a router.

## **Protection of personal information**

Personal information shot using the system is subject to the Personal Information Protection Law. Handle video information properly in accordance with the law.

※Refer to the "Guidelines for the Act on the Protection of Personal Information (General Rules)" of the Personal Information Protection Committee for examples corresponding to personal information.

## **HEVC (High Efficiency Video Coding) Patent**

This product is within the scope of one or more claims of the HEVC patent listed on [patent.list.accessidvance.com](http://patent.list.accessidvance.com).



## About Routers

When connecting the camera to the Internet and using a router, use a broadband router with a port forwarding function (NAT, IP masquerading). Please refer to the following for an overview of the port forwarding function.

→[Basic network settings, p. 309](#)

## Time Setting

It is necessary to set the time before starting operation. For the time setting, refer to the following.

→[Initial Settings, p. 34](#)



## Overview

This section contains the following information:

<b>Features</b> .....	<b>20</b>
<b>Package Contents</b> .....	<b>21</b>
<b>Dimensions</b> .....	<b>22</b>
<b>Accessories for Multisensor Cameras</b> .....	<b>23</b>
<b>Accessories for All Cameras</b> .....	<b>25</b>
<b>Further Reading</b> .....	<b>29</b>

## Features

The MOBOTIX MOVE Vandal Multisensor PTZ Combo 20MP Video Analytics Camera incorporates four 5MP fixed-lens sensors plus one 2MP (1080p) PTZ network camera with remote-controlled 21x zoom/-focus lens for optimum positioning and alignment to the application needs. The camera provides four individual video-streams plus a combined stream of all four video streams for undistorted 360° views, making it ideally suited for surveillance of large areas or road intersections. Multiple sensor modules and the integrated AI-VMD analytics features enable the detection of vehicles and motion, as well as object tracking via the motorized PTZ unit.

- 4 x 5MP multi-directional camera + 2MP (1080p) 21x PTZ camera
- Fixed-focus lens 3.2 mm (<Multisensor>) and 21x motorized zoom/focus lens 4.0 to 84.6 mm (<PTZ>)
- WDR up to 144 dB
- Quad streaming H.264/H.265/MJPEG
- Intelligent encoding, smart low-bitrate control
- MOBOTIX MxMessageSystem
- ONVIF Profile S/G/T/M support
- Integrated AI-VMD analytics
- microSD/SDHC/SDXC card support up to 512 GB
- Audio Line In/Out
- PoE++ (IEEE802.3bt compliant) DC54 V: max. 35.6 W
- Operating temperature range -40 to 55 °C/-40 to 131 °F
- Outdoor protection rate IP66/IP67, IK10
- NDAA and NEMA 4x compliant
- Built-in FIPS 140-2 Level 3-certified TPM hardware/firmware

This camera includes the pre-installed and ready-to-use AI-VMD function extension software. It uses artificial intelligence to classify and count objects moving into detection areas or crossing counting lines. Please see the →[AI-VMD for object detection and counting, p. 370](#) section in the appendix on how to use this software.

**NOTE!** Observe the [MOBOTIX MOVE Installation Hints](#) document to ensure optimum performance of the camera features.

# Package Contents

Check the package for the items listed below.

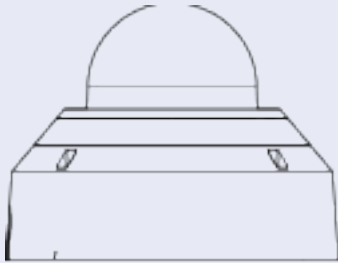

Vandal Multisensor PTZ Combo 20MP Video Analytics Camera



Base plate (attached to camera)



Grommet for cable (2x; one to use, one spare)



Torx TX20 drill bit



Ethernet cable

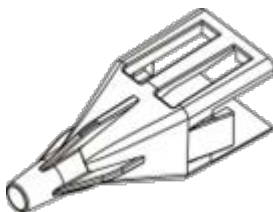

RJ-45 cap



Drilling template

**NOTE!** To purchase a power adapter, contact MOBOTIX for further information.

# Dimensions

**NOTE!** Download the drilling template from the MOBOTIX website: [www.mobotix.com](http://www.mobotix.com) > [Support](#) > [Download Center](#) > [Marketing & Documentation](#) > [Drilling Templates](#).

**CAUTION!** Always print or copy the drilling template at 100% of the original size!

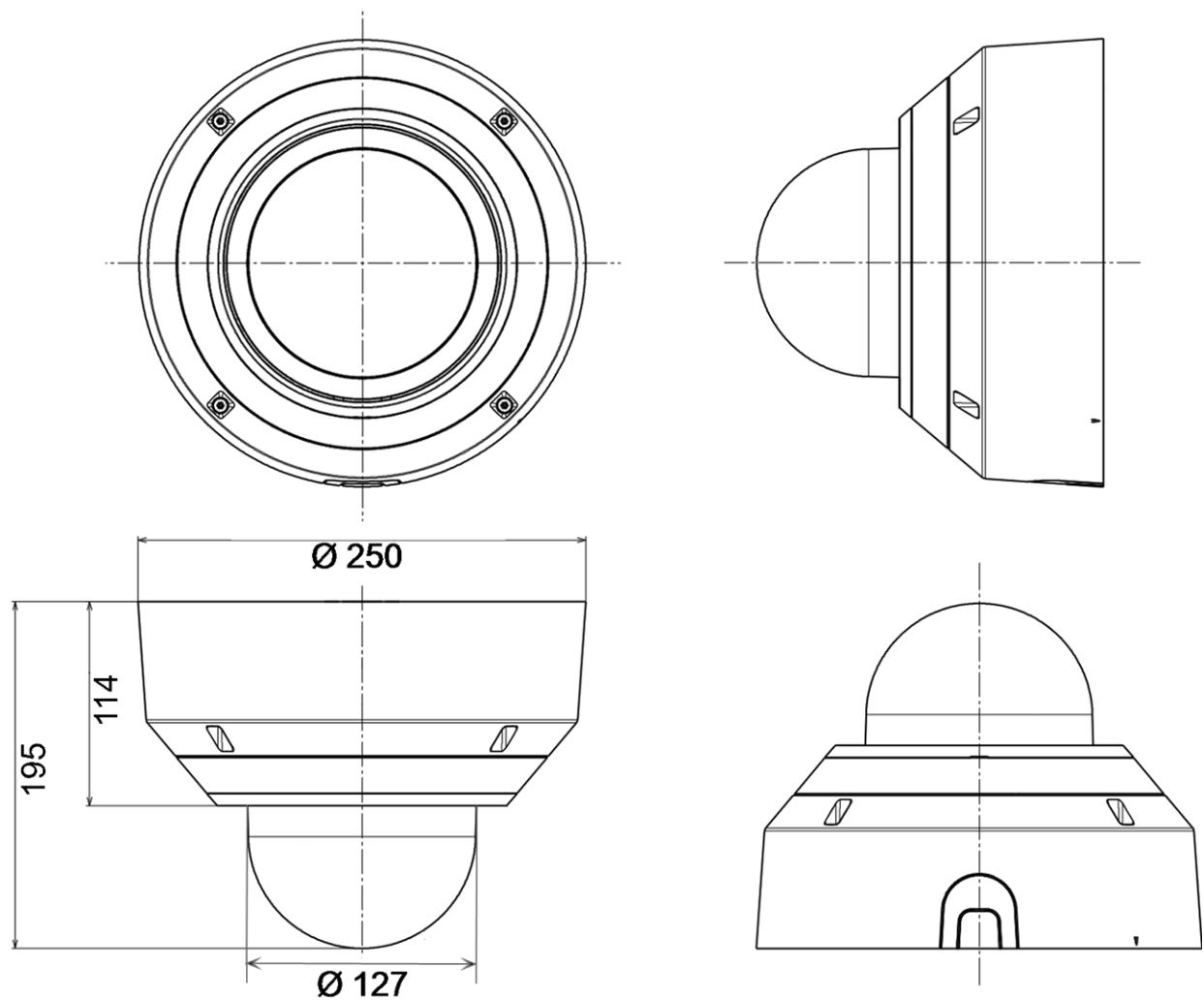

Fig. 1: Mx-VMSD1A-2021-VA: All measurements in mm

## Accessories for Multisensor Cameras

Picture/ Order Code	Description	Compatible Products	Material/ Color	Weight
 <p>Mx-M-VMSD-AP</p>	Adapter mounting plate for MOVE Vandal Multisensor PTZ Combo camera Mx-M-VMSD-2021-VA.	MOVE Vandal Multisensor PTZ Combo camera Mx-M-VMSD-2021-VA.	Die-cast ADC12 aluminium alloy, powder-coated RAL9003	1.57 kg
 <p>Mx-M-VMSD-IC</p>	Indoor in-ceiling mount for MOBOTIX MOVE Vandal Multisensor PTZ Combo camera Mx-M-VMSD-2021-VA.	MOVE Vandal Multisensor PTZ Combo camera Mx-M-VMSD-2021-VA.	Die-cast ADC12 aluminium alloy, powder-coated RAL9003	3.5 kg

# Dimensions

Order Code

Dimensions

Mx-M-VMSD-AP

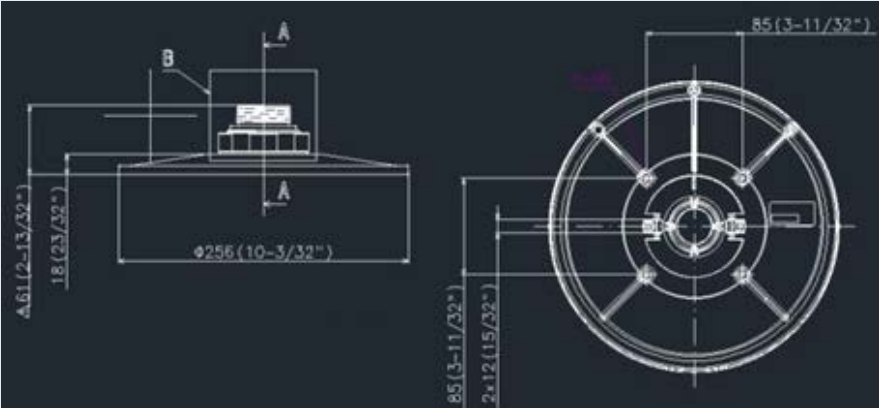

Mx-M-VMSD-IC

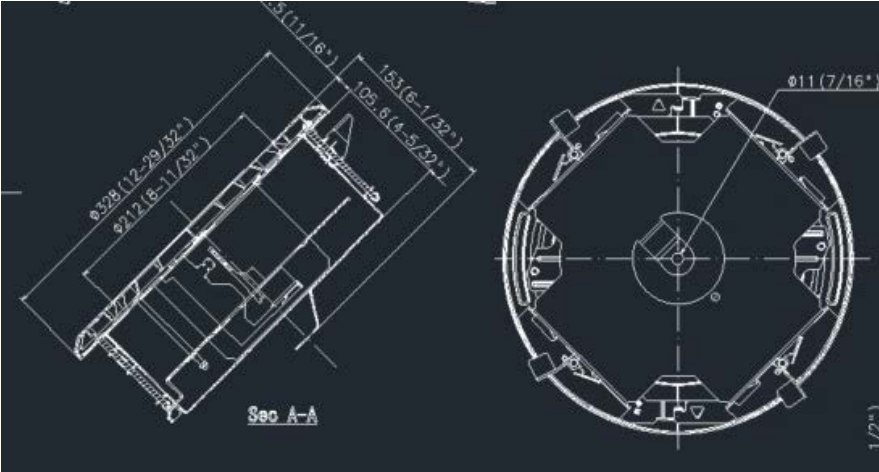



# Accessories for All Cameras

Picture/ Order Code	Description	Compatible Products	Material/ Color	Weight
 MX-NPA-UPOE1A-60W	UPoE Power Injector 60W. PoE++ 60W Network Power injector • AC Input Voltage: 100 to 240 VAC (50 to 60Hz) • AC Input Current: 1.5A @100-240 VAC • Operating Ambient Temperature: • -10° to 40°C @60W • -10° to 50°C, humidity 10 to 90% @30W • IEEE 802.3bt compliant • Output power of 60W over 4-pairs • Supports 10/100/1000Base-T applications • Plug-and-play installation • Full Protection OVP, OCP• Supports 10/100/1000Base-T applications.	All cameras.	Plastic housing, black	0.45 kg
 Mx-A-ETP1A-2601-SET	Media converter set Ethernet(PoE+) – Twisted-Pair. Complete set consisting of two two-wire transmit/receive units for establishing an Ethernet transmission path via twisted-pair cables. •	All cameras. Requires Mx-A-ETP1A-2601-POW.	Plastic housing, black	0.368 kg

Picture/ Order Code	Description	Compatible Products	Material/ Color	Weight
	<p>Transmission of Ethernet and PoE+ power supply via two-wire line according to IEEE1901.</p> <ul style="list-style-type: none"> <li>• Simple connection of 10/100 Mbps Ethernet end devices</li> <li>• Max. 95 Mbps transmission bandwidth, range up to 600 m/656 yd for data only, 300 m/328 yd for PoE depending on the quality of the twisted-pair link</li> <li>• 128 bit AES network data encryption</li> <li>• Power supply 2-wire transmitter (Tx) and receiver (Rx) as well as end device via PoE+ network switch or external power supply 56VDC / 1.2A (not included!)</li> <li>• Connected end devices are supplied via PoE switch IEEE802.3af(PoE), IEEE802.3at (PoE+), UPoE up to 60W (requires ext. power supply unit).</li> <li>• Status LEDs (data, power supply, data link, PoE)</li> <li>• Integrated Overvoltage protection (IEC 61000-4-5 4kV(1.2 / 50us), 2kA(8 / 20us))</li> <li>• Power Supply: TX: T-Linx or DC12V~57V, RX: PoE Switch or</li> </ul>			

---

Picture/ Order Code	Description	Compatible Products	Material/ Color	Weight
 <p data-bbox="236 817 523 842">Mx-A-ETP1A-2601-POW</p>	<p data-bbox="608 365 911 483">Plug-type power supply for Mx-A-ETP1A-2601-SET.</p> <p data-bbox="608 506 911 719">Output: 57V DC +/-3% / 1.2 A • Input: 90-260V AC (47-63Hz) • 68,4 Watt • Operating Temperature: 0-40°C/32-122°F</p>	<p data-bbox="932 365 1091 439">Mx-A-ETP1A-2601-SET</p>	<p data-bbox="1123 365 1235 483">Plastic housing, black</p>	<p data-bbox="1278 365 1366 389">0.49 kg</p>
 <p data-bbox="244 1216 517 1240">Mx-A-KBD1A-PTZ-JOG</p>	<p data-bbox="608 880 911 999">MOBOTIX USB Keyboard with PTZ Joystick &amp; Jog-Shuttle.</p> <p data-bbox="608 1021 911 1189">USB control panel for operating MOBOTIX MxMC 2.6 and higher and MOBOTIX HUB incl.</p> <p data-bbox="608 1211 911 1330">Control of software PTZ and motorized PTZ cameras and pan/tilt devices</p> <ul data-bbox="608 1352 911 1648" style="list-style-type: none"> <li>• Integrated 3-axis joystick</li> <li>• Integrated jog shuttle</li> <li>• 38 control keys with backlight pre-defined for MxMC functions or freely definable for MOBOTIX HUB</li> </ul> <p data-bbox="608 1671 911 1789">Integrated alarm buzzer</p> <ul data-bbox="608 1812 911 2018" style="list-style-type: none"> <li>• Suitable for operation as HID device on MOBOTIX VMS with Windows and MAC based operating systems via USB 2.0</li> <li>• Suitable for right- and left-handed</li> </ul>	<p data-bbox="932 880 1091 904">All cameras.</p> <p data-bbox="932 927 1091 1189">Requires Windows or macOS computer with USB 2.0 or better.</p>	<p data-bbox="1123 880 1235 999">Plastic housing, black</p>	<p data-bbox="1278 880 1366 904">1.9 kg</p>

## Overview

### Accessories for All Cameras

Picture/ Order Code	Description	Compatible Products	Material/ Color	Weight
 MX-SWITCH1	<p>users • Power supply: USB, max. 350 mA • Operating temperature: 0°–45°C/32–113 °F.</p> <p>MOBOTIX network switch for DIN (top-hat) rail mounting.</p> <p>5x RJ45 port with 100 MBit/s (1x uplink, 4x PoE+ with max. 75 W). Supply: 48 V DC, max. 75 W. Simplified cabling for door stations due to available connectivity for anti-theft protection, door opener and MxBus. MxBus, anti-theft protection, door and lock contact can be connected via separate wires of Ethernet cable.</p>	All cameras.	Plastic housing, gray	0.31 kg

## Further Reading

[Manuals and Quick Installation documents](#)



[Technical Specifications](#)



[MOBOTIX MOVE Installation Hints](#)



[MOBOTIX Community](#)





## Installation

This section contains the following information:

<b>General Remarks</b> .....	<b>32</b>
<b>Camera Installation</b> .....	<b>32</b>

# General Remarks

Read the instructions provided in this chapter thoroughly before installing the camera.

**NOTE!** This camera must be installed by qualified personnel and the installation must conform to all local codes.

**NOTE!** Observe the [MOBOTIX MOVE Installation Hints](#) document to ensure optimum performance of the camera features.

# Camera Installation

The Vandal Multisensor PTZ Combo 20MP Video Analytics Camera can be mounted to walls or ceilings without accessories. Please refer to the camera's Quick Installation guide available on [www.mobotix.com](http://www.mobotix.com) > [Support](#) > [Download Center](#) > [Marketing & Documentation](#) > [Manuals](#) in the **MOBOTIX MOVE Accessories** section

Using accessories (such as a pendant mount, for example) will increase the application scenarios for this camera. Please refer to [Accessories](#) to find the type of mount that is suitable for your situation.

To install the camera using one of these accessories, please refer to the corresponding Quick Installation document available on [www.mobotix.com](http://www.mobotix.com) > [Support](#) > [Download Center](#) > [Marketing & Documentation](#) > [Manuals](#) in the **MOBOTIX MOVE Accessories** section.



## Operation

This section contains the following information:

<b>Initial Settings</b> .....	<b>34</b>
<b>Viewing images from a PC</b> .....	<b>40</b>
<b>Viewing images from smart phones/tablet computers</b> .....	<b>57</b>
<b>Manually saving images on the SD Card</b> .....	<b>78</b>
<b>Operation when alarm is generated</b> .....	<b>79</b>
<b>Display the log list</b> .....	<b>81</b>
<b>Playing back images/video streams from the SD card</b> .....	<b>85</b>

# Initial Settings

## Administrator registration

The administrator registration screen is displayed when the camera is first accessed (or when the camera is initialized).

Enter an administrator's user name and password to ensure that there are no mistakes. Use the following login.

## Administrator registration

The initial setup of the administrator name and password is required on this screen.

Manage them safely and be sure not to forget them.

Perform the initial setting of both the PTZ camera and the multi-directional camera.

Set to both cameras

PTZ Camera

User name (1 to 32 characters)

Password (8 to 32 characters)

Retype password

Multi-directional camera

User name (1 to 32 characters)

Password (8 to 32 characters)

Retype password

Set

Note:

- (1) If you want to operate the PTZ camera and multi-directional camera in cooperation with screen clicking or alarm notification, Set the same user name and password on both cameras.
- (2) Distinguish between upper- and lower cases.
- (3) Entry of the following is not allowed as a user name: 2-byte characters, and 1-byte symbols " & ; ; ¥
- (4) Entry of the following is not allowed as a password: 2-byte characters, and 1-byte symbols " &
- (5) For the password, use three or more types of characters from upper- and lowercase alphabetic characters, numbers, and symbols.
- (6) Keep the user name and password at hand so as not to lose.
- (7) It is recommended to change the password periodically.
- (8) Set the password which does not include the user name.

### Set to both cameras

When the setting is performed with the checkbox checked, the **User name** and **Password** entered into the PTZ camera are also set for the Multisensor camera.

## Operation

### Initial Settings

---

If you want to set up different administrator information for the PTZ camera and the Multisensor camera, uncheck the checkbox and enter **User name** and **Password**.

#### **User name (1 to 32 characters)**

Enter an administrator username.

- Number of characters that can be entered: 1 to 32 characters
- Characters that cannot be entered: Double-byte and single-byte symbols " &; ¥

#### **Password (8 to 32 characters)/Retype password**

Enter the administrator's password.

- Number of characters that can be entered: 8 to 32 characters
- Characters that cannot be entered: Double-byte and single-byte symbols " &

#### **NOTE!**

- Enter case-sensitive data.
- Use at least three of the following passwords: uppercase alphabetic characters, lowercase alphabetic characters, numbers, and symbols.
- Configure the password so that it does not contain the user name.
- If you want the PTZ camera and the Multisensor camera to work together by screen clicking or alarm notification, set the same user name and password for both cameras.

#### **CAUTION!**

- If the set user name or password is lost, the camera must be initialized. When the camera is formatted, all settings will be cleared. Keep the user name and password out of the eyes of third parties. Refer to the Operation Manual Web Guide for the formatting method.
- Change the password periodically.
- Do not use other cameras, devices, or other passwords.

After registering the user name and password of the administrator, the Language/Datetime setting screen is displayed.

## Language/time and date

### Language/time and date setting

Menu language	Date/time display	Time display format	Date/time display format
<input style="width: 100%;" type="text" value="Auto"/>	<input style="width: 100%;" type="text" value="On"/>	<input style="width: 100%;" type="text" value="24h"/>	<input style="width: 100%;" type="text" value="Mmm-DD-YYYY"/>

Date	Time	Date/time position
<input style="width: 100%;" type="text" value="Jan-13-2023"/>	<input style="width: 100%;" type="text" value="11:43:52"/>	<input style="width: 100%;" type="text" value="Upper left"/>

Set PC time to the camera

Time zone

Summer time(daylight saving)

### Screen setting

Color	Operation panel layout
<input style="width: 100%;" type="text" value="Light"/>	<input style="width: 100%;" type="text" value="Bottom"/>

Fig. 2: Language/Datetime Settings

### Menu language

Select the first language that appears when you access the camera from the list below. **Auto/English/Japanese/Italian/French/German/Spanish/Chinese/Russian/ Portuguese**

**Auto** automatically selects the languages used by the browser. If your computer is not compatible with the language, the English language is selected.

### Time display format

Select the time display method from 24h/12h.

#### Date/time display format

Select the date display format. If **Date/time** is set to **13:10:00 on April 1, 2021**, the display formats are as follows.

- DD/MM/YYYY: 01/04/2021 13:10:00
- MM/DD/YYYY: 04/01/2021 13:10:00
- DD/Mmm/YYYY: 01/Apr/2021 13:10:00
- YYYY/MM/DD: 2021/04/01 13:10:00
- Mmm/DD/YYYY: Apr/01/2021 13:10:00

#### Date

Click the  button to set the camera date.

Click the  button to get the date of the PC and display it.

#### Time

Click the  button to enter the camera time.

Click the  button to acquire the time of the PC and display it.

#### NOTE!

If you need to set the time more accurately in system operation, use the NTP server.

→[Configuring NTP, p. 327](#)

#### Date/time position

Select the position where the date and time are displayed on the image.

- **Upper left:** Displayed in the upper left corner of the window.
- **Lower left:** Displays in the lower left corner of the window.
- **Upper center:** Displayed in the center of the window.
- **Lower center:** Displays at the bottom center of the window.
- **Upper right:** Displayed in the upper right corner of the window.
- **Lower right:** Displays in the lower right corner of the window.

#### NOTE!

To show/hide date and time information on the images, use the **Basic** pages in the **Advanced** menu.

→[Basic setup of the camera, p. 147](#)

### Time zone

Select the time zone for the camera area.

### Summer time (daylight saving)

Use **In**, **Out** and **Auto** to specify whether to use Daylight Saving Time. Set in the region where Daylight Saving Time is used.

- **In** sets the time to Daylight Saving Time. \* is displayed in the time display.
- **Out** cancels Daylight Saving Time.
- **Auto** switches to Daylight Saving Time according to the start date and time and end date settings (month, week, day of the week, and time).

### Start time & dateEnd time & date

When **Auto** is selected in **Summer time(daylight saving)**, the start date and time of Daylight Saving Time and the end date and time of Daylight Saving Time are set in Month, Week, Day of Week, and Time.

## Screen settings

### Character color

Select the background color of the operation panels and **Detailed settings** menus from the **LightDark**.

→[Detailed settings, p. 107](#)

### Operation panel layout

Select the position of the control panel from **Right**, **Left**, and **Lower**.

## Set position

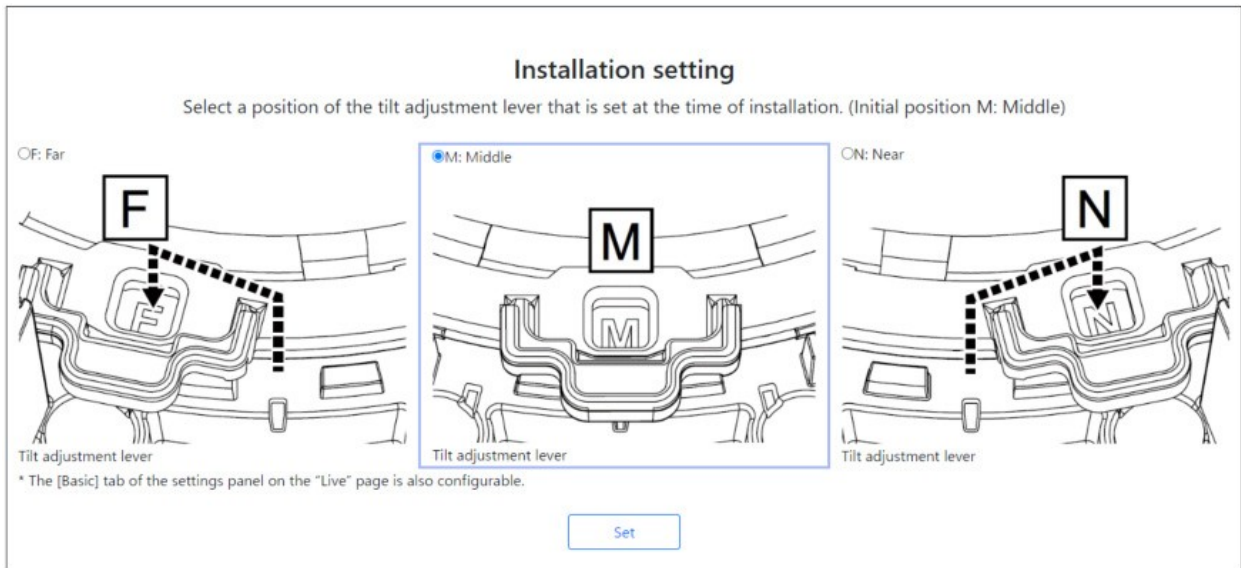

Set **Tilt adjustment lever position** to the same position you selected when installing the camera.

**NOTE!**

The **Tilt adjustment lever position** can also be set from the **Basic** tabs of the **Live Picture Settings** pane. Please refer to the following for details.

→[Basic settings, p. 96](#)

## Viewing images from a PC

### IP Address or DDNS Name?

As a general rule, you can use the IP address of a camera when accessing the camera from within the same LAN (Local Area Network). Example: `http://192.168.1.210`



When accessing the camera from *outside the LAN*, you can use one of these methods:

- **Preferred method:** Use a VPN connection to the router of the camera LAN (most modern routers support VPN connections). See the manual of your router manufacturer to see how to establish a VPN connection.

**NOTE!**

When accessing the camera from a different LAN, make sure the IP address range of this LAN is different from the IP address range of the camera LAN.

Example:

- Camera IP address in camera LAN: 192.168.1.210
  - Computer IP address in home LAN: 192.168.178.53
- Register the camera with a DDNS (Dynamic Domain Name Service) server. **Using HTTPS for this method is strongly advised!**

Example: `https://my-entrance-cam.my-ddns-server.net/`

## View camera images

1. Start the PC web browser.
2. Enter the IP addresses set in the IP Easy Configuration software in the **Address** boxes of the web browser.

Example IPv4 address:

`http://192.168.0.10/`



Example IPv6 address:

`http://2001: db8:: 10/`

### NOTE!

- If the HTTP port number is changed from **80**, enter `http://Camera IP address:<port>` in the **Address** box.  
Example for port number set to 8080: `http://192.168.0.11: 8080`
- If your camera is in a local network, configure the proxy server (**Set > Network and Internet > Proxy**) to avoid using the proxy server for the local address.
- When IPv6 is accessed, the stream image cannot be displayed on the live screen. If you want to display the stream image on the live screen, please access it via IPv4.

### NOTE!

- Due to browser limitations, there is an upper limit on the number of browsers that can display video simultaneously. If you try to display images in multiple browsers, the images may not be displayed.
- When using HTTPS, access `https://IP address: port/`.  
→[Configuring the network, p. 309](#)

3. Press the **Enter** key to display the user name and password entry screen.

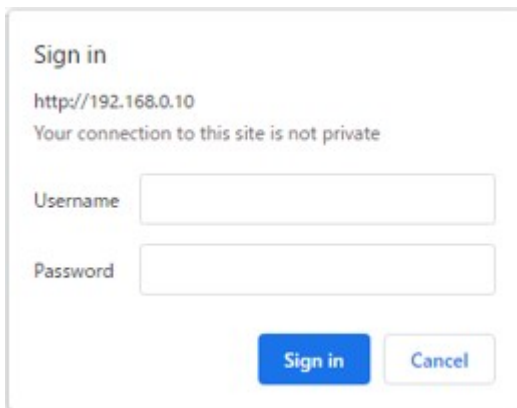

A screenshot of a 'Sign in' dialog box. The title is 'Sign in'. Below the title, it shows the URL 'http://192.168.0.10' and a warning message: 'Your connection to this site is not private'. There are two input fields: 'Username' and 'Password'. At the bottom, there are two buttons: a blue 'Sign in' button and a white 'Cancel' button with a grey border.

**NOTE!**

If **User auth.** is set to **Off**, the Username and Password entry window will not be displayed prior to the live page.

4. Enter the user name and password, and click the **OK** button to display the live picture page. For more information on live picture pages, please refer to the following.

→[About live image pages, p. 44](#)

#### CAUTION!

- Change the password periodically.
- If you try to display multiple H.265 (or H.264) images on a single PC, depending on the performance of the PC, the image may not be displayed.

#### NOTE!

- Users with simultaneous access to the camera are up to the total number of users who receive H.265 (or H.264) images and those who receive JPEG images. However, depending on the **Bandwidth control (bit rate)Bit Rate\* per Client** setting, the number of accessible users may be limited to **Max Users** or less. If the number of accessible users exceeds **Maximum number of users**, an access excess message is displayed. When **StreamTransmission type** is set to **Multicast**, the second and subsequent users receiving H.265 (or H.264) images are not counted as accesses.
- **Maximum number of users** depends on the camera part you are accessing.
  - <Multisensor>: 24 users
  - <PTZ>: 14 users
- When **Stream transmission** is set to **On**, the H.265 (or H.264) images are displayed according to the **Stream encoding format** settings. When set to **Off**, JPEG images are displayed. JPEG images can be displayed even if **Stream transmission** is set to **On**. However, in this case, the image update rate of the JPEG image is limited as shown in the table below.

→[Configuring streaming options, p. 177](#)
- The frame rate for JPEG images may be slow depending on the network environment, PC performance, subject, and number of accesses.

## About live image pages

#### NOTE!

Buttons and settings displayed on the live image page can be changed depending on the user's privileges. The user privileges are set in **User mng. > User auth.**

→[Configuring user authentication, p. 293](#)

### Live image pages for Multisensor/PTZ cameras

**NOTE!** The Multisensor and PTZ cameras have different IP addresses! To access the live image pages, enter either the IP addresses for the Multisensor camera or for the PTZ camera.

#### Multisensor camera



## Operation

### Viewing images from a PC

## PTZ camera

### Note:

**MULTI\_PTZ** The live image pages for each camera are displayed by accessing the IP addresses set for the PTZ camera and the Multisensor camera.

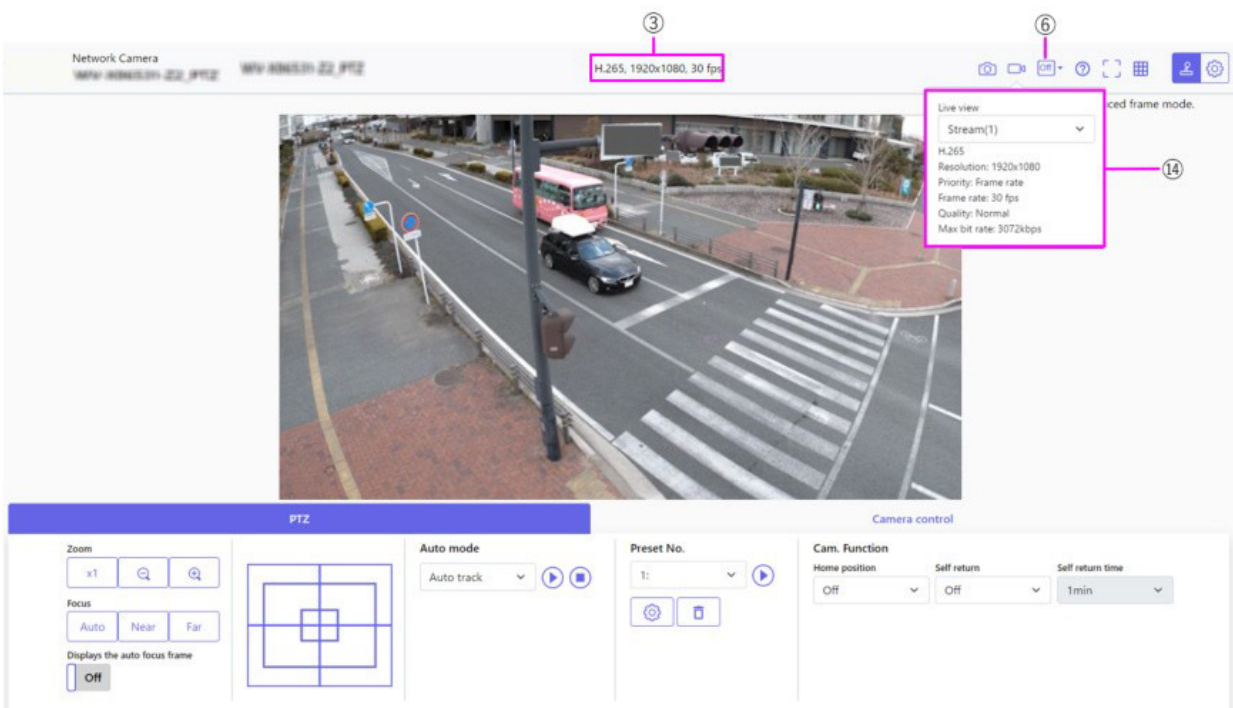
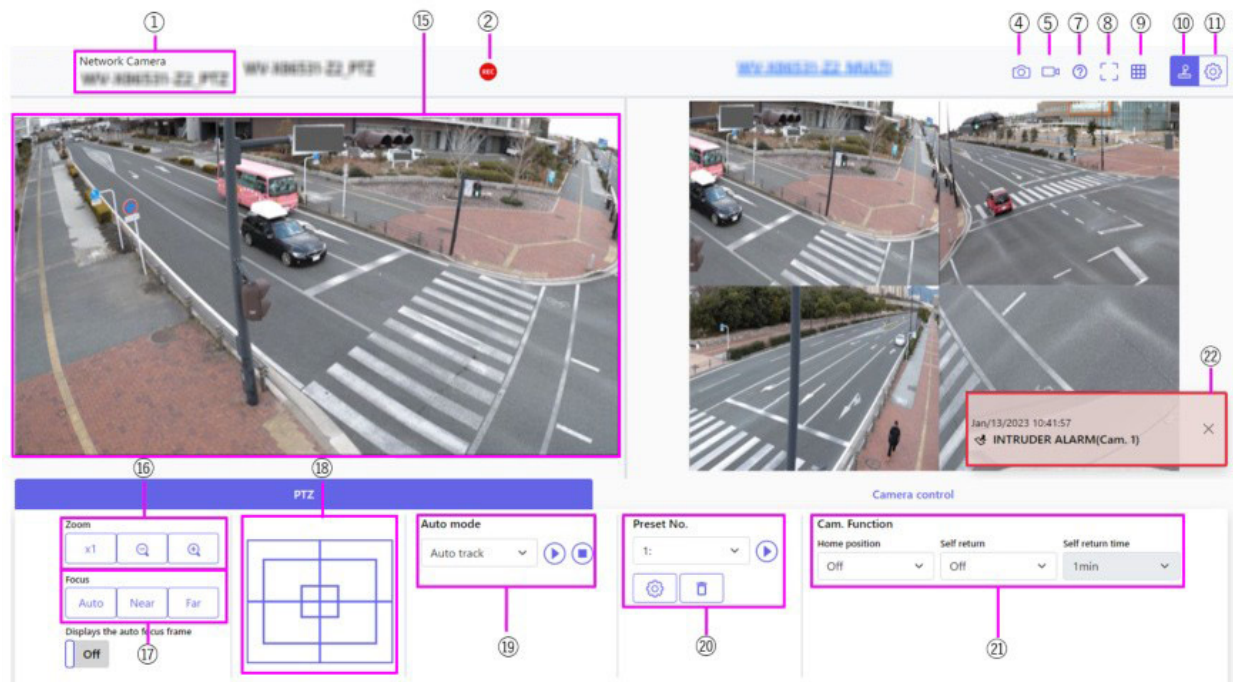

### ① Camera TitleBasic

The title of the camera entered in **Camera title** on the tab is displayed.

## ② SD Storage Status Display

Displays the storage status on the SD card.

When saving starts, the SD save status indicator turns red. The LED turns OFF when saving stops.

This is displayed when the **Save trigger** in the Setup menu is set to **Manual** or **Schedule**.

→SD card options, p. 154

## ③ View Stream Information

Displays the compression method, resolution, and frame rate of live video.

## ④ Snapshot button

A snapshot (one still image) is acquired and the image is displayed in a separate window. Right-click on the image to save the image using the web browser function.

### NOTE!

- If it takes more than a certain period of time to acquire a snapshot depending on the network environment, the image may not be displayed.
- If the specified resolution of JPEG cannot be acquired, the JPEG image with the available resolution is displayed.

Therefore, if you snapshot a JPEG image and refer to it on a PC, the image size may differ from the displayed image size.

## ⑤ Stream Selection Display button

You can toggle between displaying and hiding popup displays on the stream selection screen. In the streaming selection window, you can set the **Live view** etc.

## ⑥ Before/after image comparison toggle button

Click the icon to acquire and display the still image. You can compare the acquired still images as images before changing the image quality setting.

 **1** Displays the downloaded still image and the latest image in the same size.

 **1:** The latest image is doubled in size between the downloaded still image and the latest image.

 **View:** Only the latest image is displayed.

## ⑦ Support button

Click the Support button to display our Technical Information website in a separate window. Our technical information website includes technical information, FAQ (Frequently Asked Questions), etc.

#### ⑧ Full Screen Display Button

A new window opens displaying the full screen image.

#### ⑨ Grid display buttons

You can switch the grid display ON/OFF that can be used to adjust the machine's position when using the function extension software.

For the size of adjustments for each of the functional extensions we sell and provide, our technical information website <Control No.: C0320 > It is listed.

#### ⑩ Camera Control Panel View button

The camera control panel can be displayed or hidden. The camera control panel can be set to **Brightness**, etc.

#### ⑪ Set button

You can view or hide the setting panel.

→Basic settings, p. 93

#### ⑫ Select Streams > Live view pull-down menu

The image to be displayed in the main area can be selected from the following.

##### **PTZ camera**

**Multisensor + PTZ/[Stream(1)/Stream(2)/Stream(3)/Stream(4)]/JPEG(1)/JPEG(2)**

##### **Multisensor camera**

**Camera to be displayed** when **Quad/Triple** is selected: **Multisensor + PTZ/Stream (2)/JPEG**

**Camera to be displayed** when 1, 2, 3, or 4 are selected: **Multisensor + PTZ/Stream(1)/Stream (2)/JPEG**

The main area image is displayed according to the settings in the stream and JPEG. You can also configure the **Initial display stream** of the **Image** tabs to show the first streams that appear when you are accessing the cameras.

→Stream settings, p. 98



**NOTE!**

- When the resolution is **1280x720** or higher, the size of the browser screen may be smaller than the actual size.
- <Multisensor>: This item is not displayed when **Image capture mode** is in quad mode.
- <Multisensor>: When selecting 1, 2, 3, or 4, if the resolution is **1280x720** or higher or **Image capture mode** is Quad-mode, the size of the browser screen may be smaller than the actual size. When **QuadTriple** is selected, the size of the browser screen may be smaller than the actual size at any resolution.

### ⑬ Select Streams > Refresh Rate pull-down menu

This pull-down menu is displayed only when the JPEG image is displayed. Select how the JPEG image is displayed.

MJPEG: Displays a JPEG image as a series (MJPEG: Motion JPEG).

**Still image updates: 1 second/Refresh interval: 3s/Refresh interval: 5s/Refresh interval: 10s/Refresh interval: 30s/ Refresh interval: 60s:** Updates JPEG images (still images) at specified intervals.

**NOTE!**

- The JPEG format (still image) update interval may not be updated at the specified interval, depending on your network environment or PC.
- <Multisensor>: When **Quad/Triple** is selected in the **Live view** pull-down menu, **Refresh interval: 1s** and **Refresh interval: 3s** cannot be selected.

### ⑭ Select stream > View stream information

Displays the settings of the compression method, resolution, bit rate, frame rate, etc. of the live image being displayed.

**NOTE!**

Displays the value set in the stream. The actual bit rate and frame rate vary depending on your network environment and PC.

### ⑮ Main area

Displays the camera image.

The current date and time are displayed according to the set **Time display format** and **Date/time display format**.

→[Basic settings, p. 147](#)

The set text is displayed on the screen. The number of lines is two.

When H.265 is displayed, when the bit rate is high, it may be displayed at the refresh interval.

#### NOTE!

- Users with low access levels may temporarily change the display but do not affect the operation of the camera.
- When the shooting scene changes significantly depending on the PC, tiring (a phenomenon in which a part of the screen is misaligned) may occur due to constraints in the OS drawing process.
- When the data encryption function is enabled, the image cannot be viewed on the live screen. Use the corresponding equipment.
- When a high zoom factor image is displayed, the clicked position may not be the center of the image.
- As the tilt angle approaches 90 degrees, the difference between the specified position and the actual direction of movement will become larger, and the specified image angle may not be achieved.
- If the mouse is dragged to move to an angle that exceeds the rotational range of the camera, the camera moves to the position where it can be operated, and then the zoom factor is automatically adjusted.

#### 16 PTZ-Panel > Zoom Buttons

Adjust the zoom manually.



: Zoom out of the image (increase **Wide angle**) by a zoom factor of 1.



: Show unzoomed image (zoom factor 1.0).



: Zoom into the image (increase **Tele**) by a zoom factor of 1.

#### 17 PTZ-panel > Focus

Adjust the focus manually with the buttons.

- **Auto:** Automatically adjust focus.
- **Near:** Adjust the focus to the **Near**.
- **Far:** Adjust the focus to the **Far**.
- **Displays the auto focus frame:** When you draw a frame with the image **On**, adjust the focus (focus) to match the frame.

**NOTE!**

The following subjects cannot be focused with auto focus. Focus manually.

- A subject that is bright or reflects strong light
- Subjects over water droplets or dirty glass
- Remote and nearby subjects mixed together
- Subjects (white walls, etc.) without contrast
- A horizontal subject, such as a blind-an oblique subject-a dark subject

**18 PTZ panel-[Control pad]**

Left-click the pads and buttons to adjust the horizontal and vertical position of the image (pan tilt).

The faster the camera operates, the faster the outside of the pad is clicked. You can also drag and adjust the mouse. Zoom and focus by right-clicking.

Clicking on the upper half of the pad in the upper and lower directions will zoom in the telephoto, and clicking on the lower half will zoom in the wide angle. Clicking on the left half in the left and right directions will bring the focus (focus) close to you, and clicking on the right half will bring it far away. You can also adjust the zoom by using the mouse wheel.

**19 PTZ-panel > Auto mode**

Selecting Operation from the pull-down menu starts the selected operation.

When panning, tilting, zooming, or focusing is performed, or when the operation set in **Self return** or **Camera action on alarm** starts, it is also terminated.

→[Configuring PTZ camera functions, p. 227](#)

→[Using alarms to execute camera actions, p. 265](#)

**Automatic Tracking:** When a pre-set object to be detected is detected, the object is automatically tracked.

→[Configuring auto tracking, p. 249](#)

**Auto Pan:** The start and end positions of the predetermined pan are automatically rotated. The pivot operation continues even after the zoom and focus operations (when the **x1** button of the **Zoom** button is clicked, the pivot operation stops).

→[Configuring auto pan, p. 241](#)

**Preset Sequence 1, Preset sequence 2, Preset sequence 3:** Move the pre-registered preset positions in order from the lowest preset number.

→[Setting preset sequences, p. 239](#)

#### NOTE!

If the content of **Self return** operates at the time set by **Self return time** during the auto mode operation, the auto mode operation stops.

→[Configuring PTZ camera functions, p. 227](#)

#### ⑩ PTZ-panel > Preset No.

Select the preset position from the pull-down menu and click the **Move** button to move the camera's orientation to the preset position registered beforehand.

→[Setting preset sequences, p. 239](#)

**H** next to the number indicates the home position. Select **HomePosition** to move the orientation of the camera to the home position.

→[Configuring PTZ camera functions, p. 227](#)

If **Preset ID (0 – 9,A – Z)** is registered, the position name is displayed next to the number.

#### ⑪ PTZ-panel > Cam. Function

##### Home position

You can set the preset position as the home position. When the home position is set, **H** is displayed next to the preset position number.

→[Setting preset sequences, p. 239](#)

#### NOTE!

If you want to move to the home position when the power is turned on, set **HomePosition** to **Self return**.

##### Self return

When the time set by **Self return time** has elapsed after the manual operation is completed, the camera can automatically return to the operation mode set by the camera.

#### NOTE!

- If you want to perform the above operations when turning on the power, it is convenient to use the self-return function.
- The self-return function works even when the setting menu is displayed.
- **Patrol** can be set only when patrols are set.  
→[Configuring patrol patterns, p. 243](#)
- **Preset sequence** can be set only when preset sequence is set.  
→[Setting preset sequences, p. 239](#)

### Self return time

After the manual operation is completed, select the time before returning to the operation set by **Self return**.

### 22 Alarm notification

When an alarm is generated, it is displayed as a popup. Clicking the **X** button resets the output terminal and the display disappears.



→[Operation when alarm is generated, p. 79](#)

#### NOTE!

The alarm notification is not linked to the alarm notification operation such as recording to the SD card or mail transfer. Check the respective operation settings.

### 23 Camera Control Panel > Brightness

It can be adjusted from 0 to 255.

- Click the  button to brighten the image.
- Click the  button to darken the image.
- Click the  button to return to the default settings.

### 24 Camera Control Panel > Mic input volume (Camera to PC)

This item can be set in the following settings.

→[Audio settings, p. 102](#)

If **Audio transmission mode** is set to **Mic input** or **Interactive(Full-duplex)Interactive (Half-duplex)**

If **Audio input encoding format** is set to **AAC-LC**

Click the  buttons or move the volume cursor to adjust the earpiece volume in four steps: Off/weak/medium/strong.

Click the Listen button to turn on/off the earpiece voice (heard on PC).

#### NOTE!

- When **Audio volume control mode** is set to **Adjust Mic input** in the Setup menu, the volume cursor is not displayed when using **Audio recording** or **Audio detection**.
- →[Audio settings, p. 102](#)
- When the camera is restarted, the earpiece volume changed by the volume cursor returns to the earpiece volume set in the **Audio** tabs of the setting menus.
- →[Audio settings, p. 102](#)
- On the screen, the volume cursor can be fine-tuned, but actually it is set to one of four levels of volume.
- If you open multiple camera browsers simultaneously on the same PC, you cannot
- hear the sound of the camera browser opened later. Access and check one by one.
- If network communication is unstable, voice reception may be stopped. In this case, restart voice reception by turning on and off the earpiece button.

#### ②5 Camera Control Panel > Audio output volume (PC to Camera)

This can only be set if **Audio transmission mode** is set to **Audio output** or **Interactive(Full-duplex)Interactive(Half-duplex)** in the configuration menus.

→[Audio settings, p. 102](#)

Click the  buttons or move the volume cursors to adjust the volume of the call by four levels: **Off**, **Low**, **Middle** and **High**.

Click the Talk button to turn on/off the talking voice (from PC).

**NOTE!**

- Transmission voice can only be used when connected with HTTPS.
- If **Interactive(Half-duplex)** is set while one user is talking, the other user's listening will be stopped and the earpiece button and the talk button will not be operable. If set to **Inter-active(Full-duplex)**, other users will not be able to use the call key.
- The maximum call duration per call is set on the **Audio** tabs of the video and audio pages. The call stops after the set continuous call time. If you want to make another call, click the call button.
- When the camera is restarted, the earpiece volume/voice volume changed by the volume cursor will return to the earpiece volume/voice volume set in the **Audio** tab of the image/-voice page.
- →[Audio settings, p. 102](#)
- On the screen, the volume cursor can be fine-tuned, but actually it is set to one of four levels of volume.

## ②6 Camera Control Panel > AUX Buttons

This setting is available only when **Terminal 3** of **Alarm** is set to **AUX output** in the **Detailed settings** menu.

→[Configuring trigger conditions and actions for alarms, p. 128](#)

**Open** button: The AUX terminal is open.

**Close** button: The AUX terminal will be closed.

**NOTE!**

The names of **AUX**, **Open**, and **Close** can be changed.

→[Using alarms to change the AUX name, p. 264](#)

## ②7 SD Cards > Rec. on SD

This can only be set when **Save trigger** is set to **Manual** on the **SD card** tabs. You can manually save images to SD cards by clicking **Start**. To manually save images on the SD card, refer to the following.

→[Manually saving images on the SD Card, p. 78](#)

## ②8 SD Cards > Log/Play

Clicking **Start** displays the log list and plays back the images stored on the SD card. Please refer to the following for details of the log list and how to play back the image.

→[Display the log list, p. 81](#)

#### 29 Camera to be displayed

Select the camera to be displayed in the main area.

**Quad:** Displays images of cameras 1, 2, 3, and 4 in quadrants.

**Triple:** Displays images of cameras 1, 2, and 3 in triplicate.

1: Displays images of camera 1.

2: Displays images of camera 2.

3: Displays images of camera 3.

4: Displays images of camera 4.

#### NOTE!

This item is not displayed when **Image capture mode** is in Quad mode.

#### 30 Select Streams > Layout pull-down menu

This pull-down menu is displayed when **Camera to be displayed** is displayed in **QuadTriple** or when **Multisensor + PTZ** is selected in **Live view**.

Select the display layout of the camera image to be displayed in the main area from the following.

When **Camera to be displayedQuad/Triple** is selected: **Quadruple/ 360 deg./ 270 deg.**

When **View live imageMultisensor + PTZ** is selected: **Up/Down/Left/Right**

#### NOTE!

- **MULTI\_PTZ** If **Left/Right** is selected in **Layout**, the displayed Multi- directional camera window will be **4 split**.
- **MULTI\_PTZ** If **Up/Down** is selected in **Layout**, the displayed Multi- directional camera will be **360 deg. or 270 deg..**
- **MULTI\_PTZ** If the Multisensor camera **Image capture mode** is set to **Quad Mode**, **Up/Down** cannot be selected in **Layout**. If the Multisensor camera **Image capture mode** is changed to **Quad Mode** while **Layout** is selected as **Up/Down**, **Layout** is changed to **Left/Right**.

#### 31 Select Streams > Refresh Rate pull-down menu

This pull-down menu is displayed when **Multisensor + PTZ** is selected in **Live view**. Toggle the JPEG and stream display methods.

**MJPEG:** Displays a JPEG image as a series (MJPEG: Motion JPEG).

**Still image updates: 1 second/Refresh interval: 3s/Refresh interval: 5s/Refresh interval: 10s/Refresh interval: 30s/ Refresh interval: 60s:** Updates JPEG images (still images) at specified intervals.

**Stream:** Displays the image in stream format.



**NOTE!**

**MULTI\_PTZ** When selecting a stream, the image of the PTZ camera displays the stream (3) and the Multisensor camera displays the stream (2).

**③ PTZ-panel > PTZ**

The link to the PTZ camera is displayed with the name of the PTZ camera. When this name is clicked, the live picture of the PTZ camera is displayed.

**NOTE!**

**MULTI\_PTZ** The PTZ operation is available from the PTZ panel <PTZ>: on the PTZ camera.

## Viewing images from smart phones/tablet computers

### IP Address or DDNS Name?

As a general rule, you can use the IP address of a camera when accessing the camera from within the same LAN (Local Area Network). Example: `http://192.168.1.210`

When accessing the camera from *outside the LAN*, you can use one of these methods:

- **Preferred method:** Use a VPN connection to the router of the camera LAN (most modern routers support VPN connections). See the manual of your router manufacturer to see how to establish a VPN connection.

**NOTE!**

When accessing the camera from a different LAN, make sure the IP address range of this LAN is different from the IP address range of the camera LAN.

Example:

- Camera IP address in camera LAN: `192.168.1: 210`
- Computer IP address in home LAN: `192.168.178.53`
- Register the camera with a DDNS (Dynamic Domain Name Service) server. **Using HTTPS for this method is strongly advised!**

Example: `https://my-entrance-cam.my-ddns-server.net/`

## Viewing images from smart phones

Connect a smart phone to your LAN (Local Area Network) to display the images (MJPEG and JPEG formats) of your camera.

The following models are supported (as of April 2022):

- iPhone (iOS 8 or later)
- Android device

### NOTE!

- If the Authentication dialog appears, enter your username and password. To ensure security, change the password periodically.  
→[Configuring user authentication, p. 293](#)
- In order to view images of your computer from a mobile device, it is necessary to set up a network to connect to the Internet in advance.  
→[Configuring the network, p. 309](#)

## Accessing the PTZ camera

Enter the address (`http://<IP or DDNS address>/cam`) and press the Enter button to display the image on the device.

### NOTE!

- When using a different HTTP port than the default 80 within the same LAN (Local Area Network), enter `http://<IP address>:<port>/cam`.
- When using DDNS (Dynamic DNS) and port forwarding from outside of the LAN, enter `http://<DDNS address of router>:<port>/cam`.
- When using **HTTPS** (**Network** page > **Advanced** tab > **Connection** > **HTTPS**), enter `https://<IP or DDNS address>:<port>/cam`
- If the **Authentication** dialog appears, enter the administrator's or general user's username and password. Depending on the mobile device, you may have to enter the password every time you are switching to a different screen.
- Mobile devices cannot receive the audio stream.
- Some mobile devices may not be able to display large images. When this happens, change the **Image quality setting** of **JPEG** to a lower quality.  
→[Configuring JPEG image options, p. 174](#)

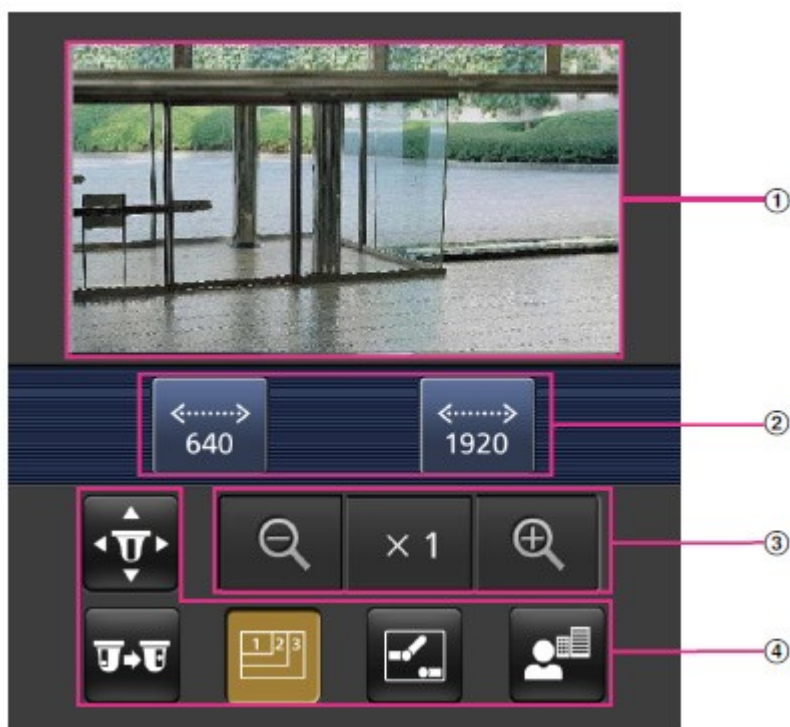

### ① Live image

Displays the area camera image.

### ② Operation button area

When the function is selected in the function selection area, the button to operate the function is displayed.

### ③ Zoom operation area

Displays the zoom button.

### ④ Function selection area

Displays and selects functions that can be operated, and the operation buttons are displayed in the operation button area.

#### NOTE!

The operation buttons displayed on the screen of the mobile terminal may not be displayed depending on the user privileges and function permission settings of the user to access. If you want to view the operations buttons, you need to set the user privileges and function permissions (**User mng. > User auth.**).

→[Configuring user authentication, p. 293](#)

Click the button of the function you want to operate.



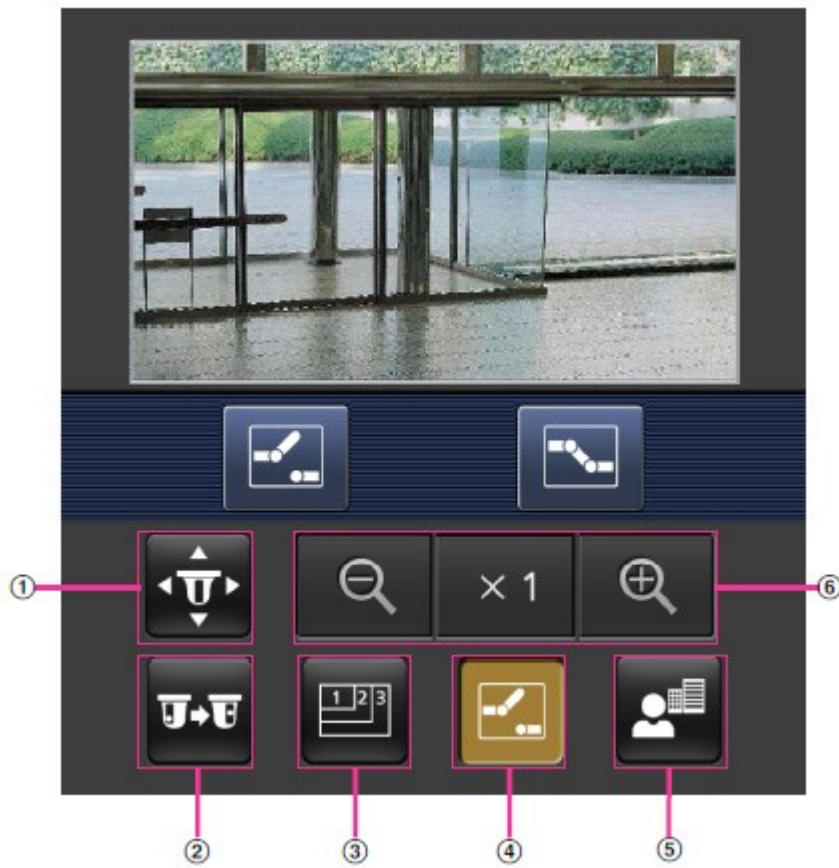

## Operation

### Viewing images from smart phones/tablet computers

---



#### ① Pan/Tilt

Press the  button to display the button to operate the pan/tilt. Use the     buttons to pan/tilt in the corresponding direction.

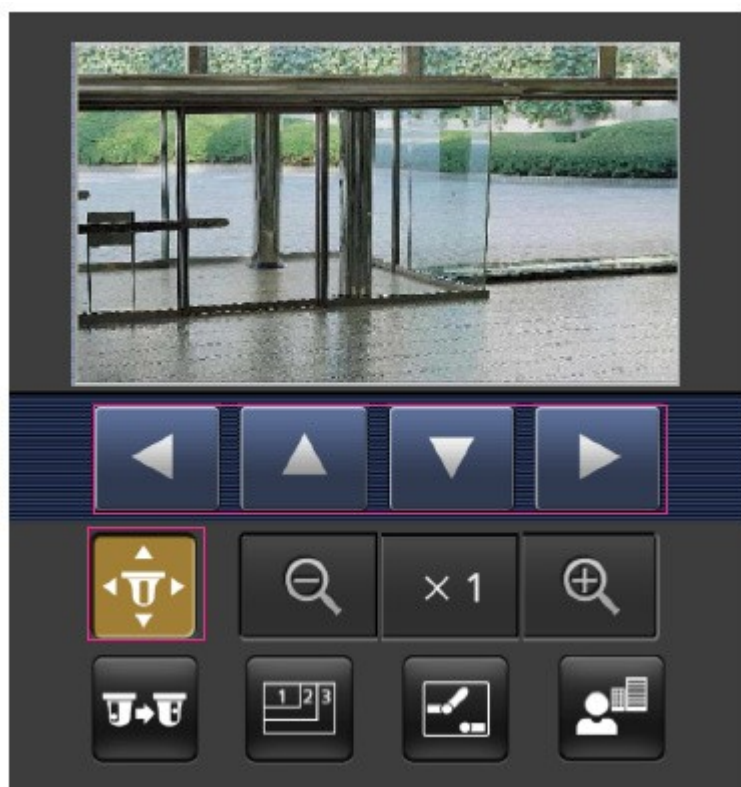

## ② Preset

Press the  button to display the button for selecting the preset position. By selecting the preset number from the displayed button, the camera image is displayed in the direction of the preset registered camera.

Only position numbers 1 to 4 are displayed for preset positions.

Only registered preset positions are displayed, and unregistered preset positions are not displayed.

## Operation

### Viewing images from smart phones/tablet computers

---

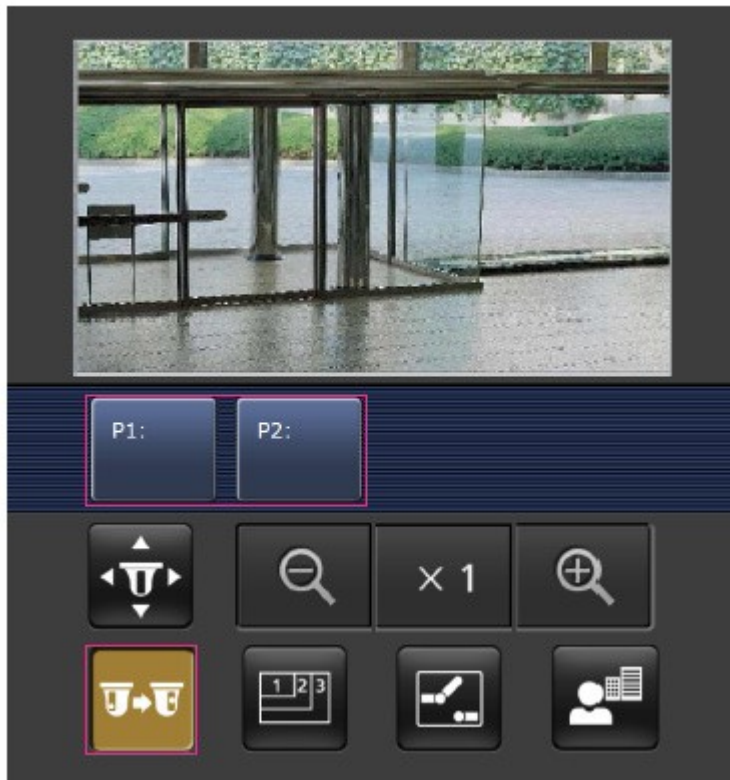

### ③ Resolution switchover



Press the  button to display the screen for selecting the resolution.

The resolution is switched by selecting the resolution from the displayed buttons.

The resolution set in **JPEG(1)/JPEG(2)** of the **JPEG** in the **Image** tab is displayed.



#### ④ Aux control

Press the  button to display the button to operate the AUX output. Use the / buttons to control the AUX output terminal.



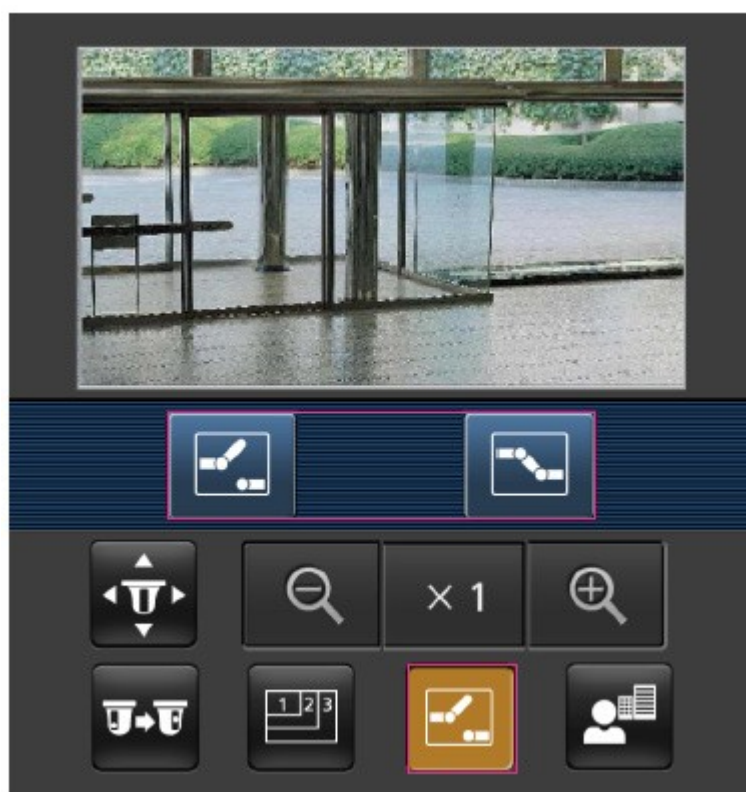

##### NOTE!

This message is displayed only when **Terminal 3** is set to **AUX output** in the operation setting menu.

→[Configuring alarms, p. 258](#)



#### ⑤ Focus Display

Press the  button to show the focus buttons. Use the // buttons to focus the camera image.



## Operation

### Viewing images from smart phones/tablet computers

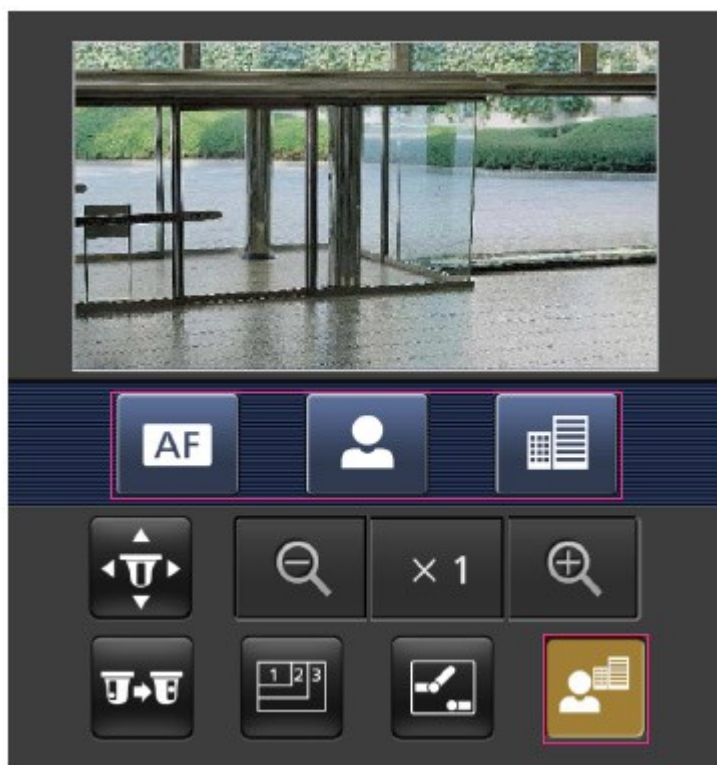
---



### ⑥ Zoom display

Use the    buttons to zoom the camera image.





**NOTE!**

The screen size displayed on the mobile phone can be changed by adding one of the following strings

- Display large: `http://<IP address>/cam/dl`
- Display medium: `http://<IP address>/cam/dm`
- Display small: `http://<IP address>/cam/ds`

The resolution displayed by **Resolution** will change, but the image size will not.

## Accessing the Multisensor camera

Enter the address (`http://<IP or DDNS address>/cam`) and press the Enter button to display the image on the device.

**NOTE!**

- When using a different HTTP port than the default 80 within the same LAN (Local Area Network), enter `http://<IP address>:<port>/cam`.
- When using DDNS (Dynamic DNS) and port forwarding from outside of the LAN, enter `http://<DDNS address of router>:<port>/cam`.
- When using **HTTPS** (**Network** page > **Advanced** tab > **Connection** > **HTTPS**), enter `https://<IP or DDNS address>:<port>/cam`
- If the **Authentication** dialog appears, enter the administrator's or general user's username and password. Depending on the mobile device, you may have to enter the password every time you are switching to a different screen.
- Mobile devices cannot receive the audio stream.
- Some mobile devices may not be able to display large images. When this happens, change the **Image quality setting** of **JPEG** to a lower quality.

→[Configuring JPEG image options, p. 174](#)

## Operation

### Viewing images from smart phones/tablet computers

---

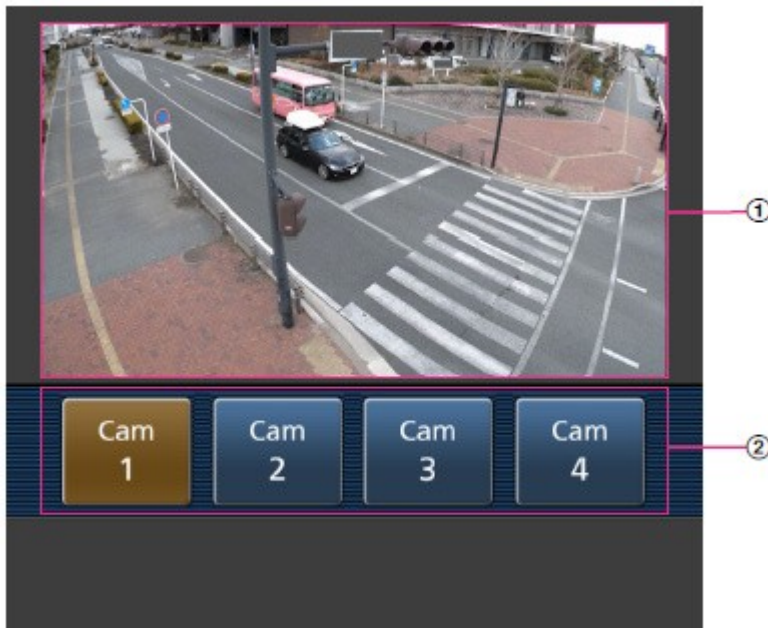

#### ① Live image

Displays the area camera image.

#### ② Camera selector

The button for selecting the camera to be displayed in the live image is displayed. Select the camera from the displayed button to change the displayed camera.

Images of cameras 1, 2, 3, and 4 are displayed at the resolution set in **JPEG** in the **Image** tabs.

#### **NOTE!**

The operation buttons displayed on the screen of the mobile terminal may not be displayed depending on the user privileges and function permission settings of the user to access. If you want to view the operations buttons, you need to set the user privileges and function permissions (**User mng.User auth.**).

→[Configuring user authentication, p. 293](#)

## Viewing images from tablet computers

Connect a tablet computer to your LAN (Local Area Network) to display the images (MJPEG and JPEG formats) of your camera.

The following models are supported (as of April 2022):

- iPhone (iOS 8 or later)
- Android device

**NOTE!**

- If the Authentication dialog appears, enter your username and password. To ensure security, change the password periodically.  
→[Configuring user authentication, p. 293](#)
- In order to view images of your computer from a mobile device, it is necessary to set up a network to connect to the Internet in advance.  
→[Configuring the network, p. 309](#)

## Accessing the PTZ camera

Enter the address (`http://<IP or DDNS address>/cam`) and press the Enter button to display the image on the device.

**NOTE!**

- When using a different HTTP port than the default 80 within the same LAN (Local Area Network), enter `http://<IP address>:<port>/cam`.
- When using DDNS (Dynamic DNS) and port forwarding from outside of the LAN, enter `http://<DDNS address of router>:<port>/cam`.
- When using **HTTPS** (**Network** page > **Advanced** tab > **Connection** > **HTTPS**), enter `https://<IP or DDNS address>:<port>/cam`
- If the **Authentication** dialog appears, enter the administrator's or general user's username and password. Depending on the mobile device, you may have to enter the password every time you are switching to a different screen.
- Mobile devices cannot receive the audio stream.
- Some mobile devices may not be able to display large images. When this happens, change the **Image quality setting** of **JPEG** to a lower quality.  
→[Configuring JPEG image options, p. 174](#)

## Operation

### Viewing images from smart phones/tablet computers

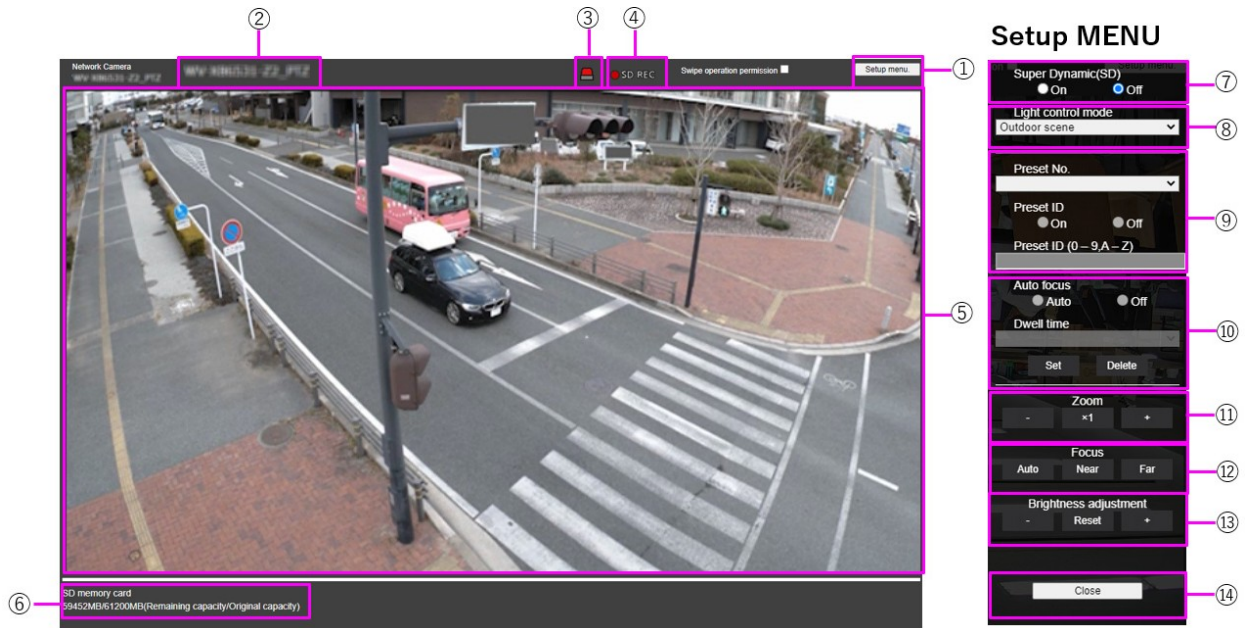

#### ① Setup menu button

**NOTE!** Only for users with access level set to **1. Administrator**.

Displays the setup menu.

#### ② Camera title

The title of the camera entered in **Camera title** on the **Basic** tab is displayed.

→Basic settings, p. 96

#### ③ Alarm Notification button

**NOTE!**

Only for users with access level set to **1. Administrator** or **2. Camera Control**

→Configuring user authentication, p. 293

The lamp flashes when an alarm is generated. Click the button to disappear.

**NOTE!**

The alarm notification button flashes in conjunction with an alarm notification such as mail transfer.

#### ④ SD Storage Status Display

Displays the storage status on the SD card. When saving starts, the SD save status indicator turns red. The LED turns OFF when saving stops.

This is displayed when the **Save trigger** in the Setup menu is set to **Manual** or **Schedule**.

→SD card options, p. 154

## ⑤ Main area

Live displays the camera image.

## ⑥ Capacity display

The remaining capacity and total capacity of the SD card are displayed.

## ⑦ Super dynamic setting

You can set **On** or **Off** to activate the super dynamic function. You can set for each preset position. This cannot be set when **Image capture mode** is in **60 fps mode** or **50 fps mode**. See **What is Super Dynamic** for details on super dynamic.

**On:** The Super Dynamic function is activated. **Off:** Stops the superdynamic function.

### NOTE!

- Set **Super Dynamic** to **Off** when the following phenomena are observed depending on the lighting condition.
  - When flickering or color changes occur.
  - When noise is generated in the bright area of the screen.
- If **Light control mode** is set to **Fix shutter**, **Super Dynamic** cannot be set to **On**.
- When **Stabilizer** is set to **On**, the superdynamic setting is **Off**.

## ⑧ Light control mode pull-down menu

Select the mode to control the light intensity from the following.

### Outdoor shooting

The brightness (illumination) controls the light intensity by combining the electronic shutter and automatic aperture. This setting is used when shooting bright objects such as outdoors. Be careful not to flicker under fluorescent lights, etc.

### Flickless (50 Hz)/[Flickless (60 Hz)]

Flicker is automatically corrected with a fluorescent lamp. 50 Hz/60 Hz will be used differently in different regions.

## Operation

### Viewing images from smart phones/tablet computers

---

#### Fixed shutter

If **Image capture mode** is in 30 fps or 15 fps mode:

**1/30 fixed, 3/120 fixed, 2/100 fixed, 2/120 fixed, 1/100 fixed, 1/120 fixed, 1/250 fixed, 1/500 fixed, 1/1000 fixed, 1/2000 fixed, 1/4000 fixed, or 1/10000 fixed**

If **Image capture mode** is in 25 fps or 12.5 fps mode:

**1/25 fixed/3/100 fixed/2/100 fixed/1/100 fixed/1/250 fixed/1/500 fixed/1/1000 fixed/1/2000 fixed/1/4000 fixed/1/10000 fixed**

When **Image capture mode** is 60 fps:

**1/60 fixed/1/100 fixed/1/120 fixed/1/250 fixed/1/500 fixed/1/1000 fixed/1/2000 fixed/1/4000 fixed/1/10000 fixed**

If **Image capture mode** is in 50fps mode:

**1/50 fixed/1/100 fixed/1/250 fixed/1/500 fixed/1/1000 fixed/1/2000 fixed/1/4000 fixed/1/10000 fixed**

#### NOTE!

- If you increase the shutter speed ( $\sim 1/10,000$ ), you will be less prone to blur even when the subject moves faster.
- Increasing the shutter speed decreases the sensitivity.
- If **Super Dynamic** is set to **On**, **Fix shutter** cannot be set. To configure **Fix shutter**, set **Super Dynamic** to **Off**.
- **Indoor scene(60Hz)** cannot be set when **Image capture mode** is in 25fps, 50fps, or 12.5fps modes.

## ⑨ Preset position setting

Sets the preset position.

Before registering the preset, move the camera in the direction you want to register.

To change the orientation of the camera, enable **Swipe operation permission** and select the image position to be centered on the image angle. The camera's orientation moves to a position centered on the clicked position.

If you want to zoom in, enable **Swipe operation permission** and select the zoom area in the picture.

**NOTE!**

When registering a preset position using a tablet, pay attention to the following.

- If updating of the image on the tablet is slow, it is recommended that you register the preset while viewing the image on the confirmation monitor.
- If you resize the screen with tablet operation, you may not be able to change the orientation or zoom in on the screen.
- If you cannot adjust the orientation of the camera with the tablet operation, refer to the following to move the camera orientation in the direction you want to register.

→[Viewing images from smart phones/tablet computers, p. 57](#)

**Preset No.**

Set the position number to be registered.

**Preset ID**

Use **On** and **Off** to set whether the position name is displayed. You can set for each preset position.

**On:** Displays the position name.

**Off:** The position name is not displayed.

**NOTE!**

- If you set a **Preset ID**, be sure to press **Register**.
- When set to **On**, the position name is displayed where you set the position in **Camera title position** on the **Basic** tab.

**Preset ID**

Enter the name to be displayed on the image for each preset position.

- Max. number of characters: 40
- Input characters: "0-9a-zA-Z" (single-byte), "! " # \$ % & ' ( ) \* +, -. /:; =?" (single or double-byte)

**NOTE!**

- If you set a **Preset ID**, be sure to press **Register**.
- The position name entered is displayed next to the preset position number in the pull-down. If **Preset ID** is set to **On**, it can also be displayed on the images.

**🔒 Auto focus**

Use **Auto** and **Off** to set whether auto focus is performed after the preset is moved. You can set for each preset position.

**Auto:** Auto focus is performed after the preset is moved.

## Operation

### Viewing images from smart phones/tablet computers

---

**Off:** Auto focus is not performed after moving the preset.

#### NOTE!

When presetting a subject whose depth does not change, a subject whose contrast is low, or a subject with high brightness such as a spotlight, etc., set **Off** and register the preset position after setting the focus.

### Stopping time

During the preset sequence operation, select the time to reflect the image of each preset position (the time when the camera stops rotating) from the following.

**5s/ 10s/ 15s/ 20s/ 25s/ 30s**

#### NOTE!

- The preset position set to **Off** does not move to that position during the preset sequence, but instead moves to the next preset position.
- Depending on the stop time setting, the camera may move to the next preset position during auto focus operation.
- Using this feature extensively will increase wear of the PTZ drive parts of the camera. You will have to replace the parts earlier than anticipated.

## ⑪ Zoom

Adjust the zoom manually.

-: Zoom out of the image (increase **Wide angle**) by a zoom factor of 1.

**x1:** Show unzoomed image (zoom factor 1.0).

+: Zoom into the image (increase **Tele**) by a zoom factor of 1.

## ⑫ Focus

Adjust the focus manually.

**Auto:** Automatically adjust focus.

**Near:** Adjust the focus to the **Near**.

**Far:** Adjust the focus to the **Far**.



**NOTE!**

The following objects cannot be focused with auto focus. Focus manually.

- Bright or intense light-reflecting objects
  - Objects over water droplets or dirty glass
- Remote and nearby objects mixed together
  - Objects (white walls, etc.) without contrast
  - Horizontal objects such as blinds or shades
- Oblique objects
- Dark objects

### **13** Brightness adjustment buttons

Adjust the brightness.

Press the **Light (+)** button to brighten the image.

Press the **Dark (-)** button to darken the image.

## Accessing the Multisensor camera

Enter the address (`http://<IP or DDNS address>/cam`) and press the Enter button to display the image on the device.

**NOTE!**

- When using a different HTTP port than the default 80 within the same LAN (Local Area Network), enter `http://<IP address>:<port>/cam`.
- When using DDNS (Dynamic DNS) and port forwarding from outside of the LAN, enter `http://<DDNS address of router>:<port>/cam`.
- When using **HTTPS** (**Network** page > **Advanced** tab > **Connection** > **HTTPS**), enter `https://<IP or DDNS address>:<port>/cam`
- If the **Authentication** dialog appears, enter the administrator's or general user's username and password. Depending on the mobile device, you may have to enter the password every time you are switching to a different screen.
- Mobile devices cannot receive the audio stream.
- Some mobile devices may not be able to display large images. When this happens, change the **Image quality setting** of **JPEG** to a lower quality.  
→[Configuring JPEG image options, p. 174](#)

## Operation

### Viewing images from smart phones/tablet computers

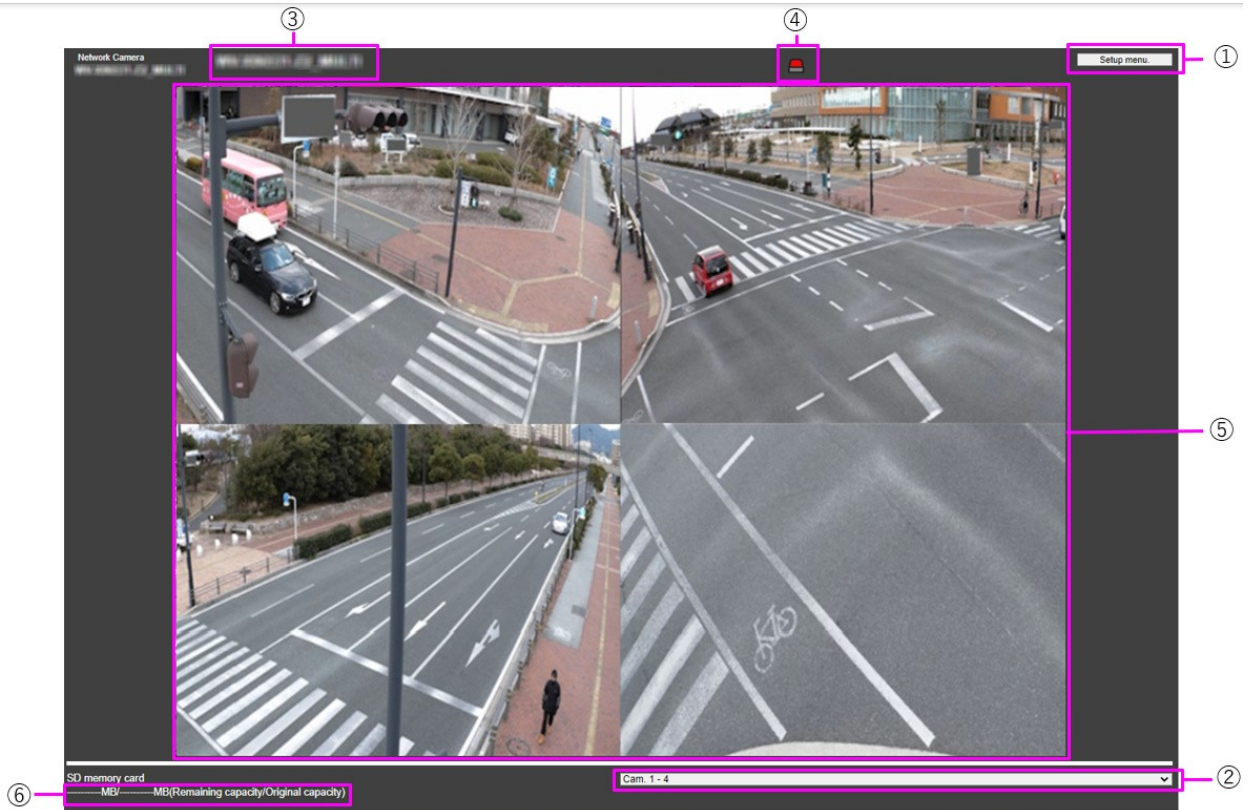

#### ① Setup menu buttons

**NOTE!** Only for users with access level set to **1. Administrator**.

These buttons will display the setup menu.

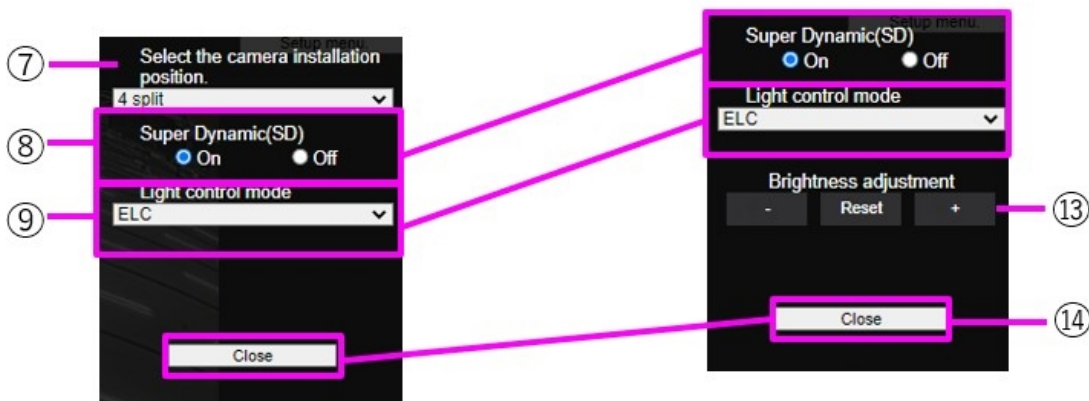

**Camera Selector** set to *Cam.1-4* or *Cam.1-3* **Camera Selector** set to *Cam.1*, *Cam.2*, *Cam.3*, or *Cam.4*

#### ② Camera Selector

Selects the camera image displayed in area ⑤.

**Camera 1 to Camera 4:** Images of camera 1, 2, 3, and 4 are displayed at the same time. Displayed according to the settings in ⑦ **Layout Setup** pull-down menu.

**Camera 1 to Camera 3:** Images of camera 1, 2, and 3 are displayed at the same time. Displayed according to the settings in ⑦ **Layout Setup** pull-down menu.

**Camera n:** Displays only the image of the selected camera.

### ③ Camera title

The title of the camera entered in **Camera title** on the **Basic** tab is displayed.

→Basic settings, p. 96

### ④ Alarm Notification button

#### NOTE!

Only for users with access level set to **1. Administrator** or **2. Camera Control**

→Configuring user authentication, p. 293

The lamp flashes when an alarm is generated. Click the button to disappear.

#### NOTE!

The flashing of the alarm notification button is not linked to the alarm notification operation such as recording to the SD card or mail transfer. Check the setting of each operation.

### ⑤ Main area

Displays the camera's live image.

### ⑥ Capacity display

Shows the remaining capacity and total capacity of the SD card.

### ⑦ Layout Settings pull-down menu

Select from **4 split**, **360 deg.** and **270 deg.** for the layout of the images to be displayed in area ⑤. The **Layout Setting** pull-down menu is displayed when **Camera 1** to **Camera 4** and **Camera 1** to **Camera 3** are selected from the **Camera Selector**.

**360-degree shooting:** Images of camera 1, 2, 3, and 4 are displayed side by side. Select this when you want to place camera 4 horizontally, such as when you want to take a wide range of pictures.

**270-degree shooting:** Images of camera 1, 2, and 3 are displayed side by side. Select this when you want to shoot a wide area.

**Divide into four pieces:** Images of cameras 1, 2, 3, and 4 are displayed in quadrants.

### ⑧ Super dynamic setting

You can set **On** or **Off** to activate the super dynamic function for each preset position. See **What is Super Dynamic** for details on super dynamic.

**On:** The Super Dynamic function is activated.

**Off:** Stops the superdynamic function.

#### NOTE!

Set **Super Dynamic** to **Off** when one of the following occurs:

- Flickering or color changes.
- Image noise in the bright area of the screen.

## ⑨ Light control mode pull-down menu

Select the mode to control the light intensity from the following.

**Flickeress (50 Hz)/Flickeress (60 Hz):** Flicker is automatically corrected with a fluorescent lamp. 50 Hz/60 Hz will be used differently in different regions.

**ELC:** The electronic shutter is used to control the light intensity.

## ⑩ Manual zoom adjustment

Adjust the zoom manually.

-: Zoom out of the image (increase **Wide angle**) by a zoom factor of 1.

**x1:** Show unzoomed image (zoom factor 1.0).

+: Zoom into the image (increase **Tele**) by a zoom factor of 1.

#### NOTE!

Observe the difference of the zoom (magnification) between the optical zoom and EX optical zoom:

- With mask area, privacy zone, operation detection area, screen change detection area, or VIQS area set, activating the EX optical zoom will shift the position.

You should therefore set the EX optical zoom first, then set each area.

→[Setting mask areas, p. 201](#)

→[Setting the privacy zone \(Privacy zone setting screen\), p. 210](#)

→[Defining VMD areas for motion detection, p. 279](#)

→[Defining SCD areas for screen change detection, p. 283](#)

→[Defining VIQS areas, p. 221](#)

## ⑪ Manual focus adjustment

Adjust the focus manually.

**Near:** Adjust the focus to the **Near**.

**Reset** returns focus (focus) to its default settings.

**Far:** Adjust the focus to the **Far**.

**NOTE!**

One-click on the **Near** or **Far** buttons may appear to have no change in focus due to trace adjustments. If you want to move the focus position by a large amount, press and hold the button for a long time.

## ⑫ Auto focus

When **Execute** is clicked, the auto focus function is activated to automatically adjust the focus to the subject in the center of the picture.

- If auto focus is executed while the slow shutter is running (e.g. at night) with the **Maximum shutter** set to a longer time than **1/30s maximum** (2/30s maximum], **4/30s maximum**, **6/30s maximum**, **10/30s maximum**, or **16/30s maximum**), it may take a lot of time to complete auto focus.
- The focus may not be adjusted automatically in the following locations or subject. In this case, adjust the focus manually.
  - Large variation in illumination
  - Low illumination
  - Extremely bright or reflected light
  - Where the dome cover is prone to contamination
  - When the image is flickering
  - When the image is switched from color to black and white in the near infrared region, the focus may shift due to the optical characteristics. If **Focusing at Day & Night switching** is set to **Auto** or **Preset**, the camera can focus automatically (it does not support the lighting change after the focus operation is completed).

## ⑬ Brightness adjustment buttons

Adjust the brightness. **Brightness adjustment** buttons are not displayed when **Camera 1** to **Camera 4** and **Camera 1** to **Camera 3** are selected from the **Camera Selector**.

Press the **Light (+)** button to brighten the image.

Press the **Dark (-)** button to darken the image.

Press **Reset** to return to the default brightness.

## ⑭ Close button

**NOTE!** Only for users with access level set to **1. Administrator**.

Hide the Setup menu.

## Manually saving images on the SD Card

You can manually save the image on the live image page to the SD card.

This function is available only when **Save trigger** is set to **Manual** by clicking the **SD card** tab on the Basic page of the Advanced Menu.

In the **Recording format** of the **Advanced** menus, you can opt to save either **JPEG** or **Stream**. If JPEG is selected in **Recording format**, a still image is saved. Selecting **Stream** will save a video.

### NOTE!

- **Recording format** can be set only for streams.
- **Manually** saves all camera videos at the same time.

1. Live image pages are displayed.  
→[View camera images, p. 42](#)
2. Click **Camera control** to view the **Camera control** panels.
3. **SD card**-starts saving to the SD card by clicking **Start** on the **Rec. on SD**. The SD save status indicator turns red during storage.  
→[About live image pages, p. 44](#)
4. The saved intervals are set on the **SD card** tabs of the basic pages.  
→[SD card options, p. 154](#)
5. To stop storing images on the SD card, press the **Stop** buttons for **SD card > Rec. on SD**. The SD save status indicator turns OFF when saving is stopped.
6. Close the **Camera Control Panel** by clicking **Camera control**.

**NOTE!**

- Images saved on the SD card can be downloaded from the Log List screen to the PC by clicking the **Start** button on the **Log/Play** button on the Live screen.  
The download function allows saving to the PC.  
→[Playing back JPEG images, p. 87](#)  
→[Playing back videos, p. 89](#). The destination for storing image data is the fixed folder in the SD card.  
→[SD card folder structure, p. 419](#)
- If you click the **Stop** button and then immediately click the **Start** button, the image may not be saved. If so, click **Start** again.
- To use this function correctly, format the SD card on your computer before using the SD card.

## Operation when alarm is generated

When the following alarms are generated, the machine performs an alarm operation according to the setting (camera operation associated with alarm generation).

### Alarm type

- **Terminal alarm:** When an alarm device such as a sensor is connected to the alarm input terminal, an alarm is activated when the connected alarm device operates.
- **VMD alarm:** When a change (movement) is detected in the image in the set operation detection area, an alarm is activated (VMD – Video Motion Detection).
- **Scene change detection (SCD) alarm:** The alarm is activated when the subject is changed by covering the camera with a cloth or a lid, or changing the camera direction significantly.  
**Command alarm:** When a unique alarm notification is received from the connected device via the network, an alarm is activated.
- **Audio detection alarm:** An alarm is activated when the set sound detection threshold is exceeded.  
**Alarm Notification from Function Extension Software:** When the function extension software with an alarm function is installed, an alarm is activated when an alarm is generated.

## Operation when alarm is generated

### Display alarm notification on live image page

When an alarm is generated, the alarm notification is displayed on the **Live** page.

→[About live image pages, p. 44](#)

### Notification of device connected to the output terminal of the alarm

When an alarm is activated, a signal can be output from the output terminal to sound an alarm, etc. The outputs are set on the **Alarm** tabs of the alarm pages.

→[Configuring output terminal alarms, p. 262](#)

### Save images on the SD card

When an alarm is activated, images (JPEG/H.265/H.264) are saved on the SD card. To save images on the SD card, use the **SD card** tab on the basic page and the **Alarm** tab on the alarm page.

→[SD card options, p. 154](#)

→[Configuring alarms, p. 258](#)

### Email notification

When an alarm is generated, an email notifying that an alarm has occurred (alarm notification) is sent to the previously registered email address. You register up to four mail messages to send alarms. You can also attach a still image to send an alarm mail. Alarm mail is set on the **Alarm** tab of the alarm page and on the **Advanced** tab of the network page.

→[Configuring alarms, p. 258](#)

→[Configuring SMTP \(E-mail\), p. 315](#)

### Alarm notification of the specified address

This function is useful when using devices manufactured by us (network disk recorder, etc.). When **TCP alarm notification** is set to **On**, the computer can be notified that it is in the alarm condition. You can set your own alarms by using the **Notification** tabs on the alarm pages.

→[Configuring unique alarm notifications, p. 288](#)



## HTTP alarm notification

When an alarm is generated, the alarm is sent to the pre-registered HTTP server. You can register up to five HTTP servers. You can also set the URL you want to send to the HTTP server. The HTTP alarm is set on the **Notification** tab of the alarm page.

→[Configuring HTTP alarm notifications, p. 291](#)

## Display the log list

The following history is displayed in the list.

**Alarm Log:** The alarm date and time, recording period, and alarm cause can be checked.

**Manual/Schedule Storage Log:** You can check the log and recording period when saved manually or in schedule settings.

1. Show live image pages.
2. Press the **View Camera Control Panel** button to display the camera control panel.
3. 3 SD card – When the **Start** button of the **Log/Play** is clicked, the Log List window is displayed in a separate window.

## Operation

### Display the log list

The screenshot shows a user interface for displaying log data. At the top, a time range is shown: "Time Jan/12/2023 16:19:21 - Jan/13/2023 13:59:42". Below this, there are two main sections. The first section, labeled "Event", has a radio button for "All" (selected) and a "Select" option with three checkboxes: "Alarm log", "Manual/Schedule log", and "FTP/SFTP trans. error log". The second section, labeled "Recording time", has "From" and "To" fields. The "From" field is set to "First recording" and the "To" field is set to "Last recording". Both fields have a date format "YYYY/MM/DD HH:MM:SS" and a corresponding input box. A "Search" button is located to the right of the "Recording time" section. Below these sections is a table with three columns: "Time & date", "Duration", and "Event". The table contains six rows of log entries. At the bottom of the screen, there is a section for "SD memory card" showing "59432MB/61200MB(rem./org.)" and three icons: a trash can, a download arrow, and a close button (X).

① Time Jan/12/2023 16:19:21 - Jan/13/2023 13:59:42

② Event  
 All  
 Select  
 Alarm log  
 Manual/Schedule log  
 FTP/SFTP trans. error log

③ Recording time  
From First recording [YYYY/MM/DD HH:MM:SS]  
To Last recording [YYYY/MM/DD HH:MM:SS]

④ Search

Time & date	Duration	Event
<a href="#">Jan/13/2023 13:57:02</a>	<a href="#">00:02:40</a>	MN/SC
<a href="#">Jan/13/2023 13:54:59</a>	<a href="#">00:00:29</a>	MN/SC
<a href="#">Jan/13/2023 10:49:13</a>	<a href="#">00:02:05</a>	MN/SC
<a href="#">Jan/13/2023 10:47:54</a>	<a href="#">00:01:14</a>	MN/SC
<a href="#">Jan/13/2023 09:45:18</a>	<a href="#">00:01:49</a>	MN/SC
<a href="#">Jan/12/2023 16:19:21</a>	<a href="#">00:01:05</a>	MN/SC

⑤

SD memory card  
59432MB/61200MB(rem./org.)

**NOTE!** The log list display screen cannot be accessed by multiple users simultaneously.

## ① Recording period

Displays the period of recording saved on the SD card.

## ② Recording stream

Select the recording stream in which you want to view the log.

**Camera *n*:** Shows the logs recorded by **Recording stream** for the selected camera.

### NOTE!

- Only the Multisensor camera can select the recording stream.
- Recorded images in the Quad mode include images from all cameras, so any camera can be searched.

## ③ Event

Select the type of log that is displayed in the log list.

**All:** Displays all logs.

**Select:** Only the logs of the selected type are displayed.

- **Alarm Log:** Displays the log when an alarm is generated.
- **Manual/Schedule Save Log:** Displays the log for manual saving and schedule saving.

## ④ Recording time

Specify the duration of the log to be displayed in the log list.

**From:** Sets the start point of the period to be displayed in the log.

- **First recording:** The first log saved on the SD card is displayed.
- **Today:** Displays today's logs.
- **Yesterday:** Displays logs from yesterday to today.
- **Last 7 days:** Displays logs from 6 days ago to the present day.
- **Last 30 days:** Displays logs from 29 days ago to today.
- **Date/time:** Displayed from the date and time log entered in the date and time specification box.

**To:** When **First recording** and **Date/time** are set in **Start**, set the end of the time period to be displayed in the log.

- **Last recording:** Displays the last log saved on the SD card.
- **Date/time:** The date and time log entered in the Date and Time Setting box is displayed.

## ⑤ Search button

**Event** searches for logs according to the condition specified by **Recording time**. The search results are displayed in the log list.

## ⑥ Log list

The log search results are displayed. **Time** allows playback of recorded data by clicking **Record Period**.

: Displays the first log.

: Displays the log list for the previous page.

: Displays the log list for the following pages.

: Displays the last log.

**Time & data**: Displays the date and time the log was recorded.

### NOTE!

- If **Time display format** is set to **24h**, the alarm date and time is displayed in 24-hour format.
- The timing of logging is as follows.
  - **Alarm Log**: The date and time of the alarm is logged.
  - **Manual/Schedule Save Log**: The date and time when saving to the SD card was started by manual or schedule setting is recorded as a log. To save continuously, logs are logged at hourly intervals (12 o'clock, 1 o'clock, 2 o'clock, etc.) when **Recording format** is JPEG. Also, when **Recording format** is streamed, logs are logged every hour from the beginning of recording.

**Duration**: Displays the length of time data was saved on the SD card.

### NOTE!

The difference between the recording end time and the recording start time is rounded to the nearest 0.1 second. Therefore, when only one JPEG image is recorded, the recording time is displayed as 00:00:00.

**Event**: Displays the cause of the log.

- MN/SC: Logs by Manual Save and Schedule Save
- TRM1: Alarm caused by alarm input to terminal 1
- TRM2: Alarm caused by alarm input to terminal 2
- TRM3: Alarm caused by alarm input to terminal 3

- VMD: Alarm due to operation detection alarm SCD: Alarm due to screen change detection alarm
- COM: Command Alarm
- AT: Alarm due to automatic tracking alarm
- INT: Intrusion alarm by AI-VMD
- LOI: Alarm on AI-VMD
- DIR: Direction alarm with AI-VMD
- CLD: Line cross alarm with AI-VMD

**SD card:** Displays the remaining capacity and total capacity of the SD card.

**Delete** button : Deletes the log list for all pages. When searched, the retrieved "b" deletes the list only. The image associated with the deleted log list is also deleted.

- If the SD card contains a lot of recorded data, it may take several hours to complete deletion. In such a case, format it. However, all images are deleted by formatting.
- During deletion, saving by alarm, manual saving, and schedule saving are not available.
- Do not turn off the power to the camera until deletion is complete. If the camera power is turned off during operation, data may remain on the SD card. In this case, click on  again in the log list screen where the deletion operation was performed.

**Download** button : You can download the total number of logs in the displayed list to the PC.

#### NOTE!

You can download up to 50,000 logs per SD card. If the number exceeds 50,000, it will be overwritten from the old log. If the total number of log lists is large, it may take longer to download.

**Close** button : Closes the **Log List** screen.

## Playing back images/video streams from the SD card

Click **Time** in the Log List window to switch the live image page to the Playback page. The display format varies depending on the **Recording format** of the SD card.

#### NOTE!

- The image updating speed may be slow during playback or downloading of the image.
- If the number of images stored on the SD card is large, it may take a long time before the images are displayed on the playback page.
- When the aspect ratio is **4:3**, the image is displayed in VGA size on the playback page regardless of the resolution of the image stored on the SD card. When the aspect ratio is **16:9**, the image is displayed in **640x360** on playback pages regardless of the resolution of the image stored on the SD card. Therefore, the playback page may look rough.
- During recording to the SD card, the playback updating speed may be slow.
- When playing back images recorded in H.265, the recording bit rate may be displayed at refresh intervals if it is high.
- Multiple cameras cannot be played simultaneously except in Quad mode.

## Playing back JPEG images



If the SD card contains an image associated with the date and time of clicking, the first image is displayed.

### ① Number of images

The total number of images saved at the time of clicking and the number of images being displayed are displayed.

#### **NOTE!**

Enter the number of the image to be displayed and press Enter on the keyboard. The image with the specified number is displayed on the screen.

## Operation

### Playing back images/video streams from the SD card

---

◀◀ **Fast Reverse Playback** button: Click this button to increase the playback speed. During fast reverse playback, click the ◀ button to return to normal playback speed.

◀ **Reverse playback** button: Starts playback in reverse mode.

▶ **Play** button: Starts regular playback.

▶▶ **Fast playback** button: Click this button to increase the playback speed. During fast playback, click the ▶ button to return to normal playback speed.

⏮ **First** button: Displays the first image.

◀ **Reverse frame advance** button: Click the button during playback to display the previous image and pause it. Click **Pause** to display the previous image each time you click the button.

#### NOTE!

Press and hold the button to count the number of images. When the button is released, the count-down of the image number stops and the image of the number when the button is released is displayed.

⏸ **Pause** button: Click to pause/resume playback.

■ **Exit** button: Exit the playback and return to the live image page.

▶▶ **Frame advance** button: Click the button during playback to display the next image and pause it. Click **Pause** to display the next image each time you click the button.

#### NOTE!

Press and hold the button to count the number of images. Releasing the button stops incrementing the counter and displays the number.

⏭ **Last** button: Displays the last image.

📄 **Download** button: The selected image is downloaded to the PC (download folder as set in the browser settings).



**NOTE!**

- During download, the playback screen cannot be operated. Operation should be completed after downloading.
- If **Cancel** is clicked during download, the download will be canceled. The video data downloaded prior to clicking **Cancel** is saved to the computer.
- If the video data is larger than approx. 60 MB, the camera will split it into chunks of that size.
- H.264 videos saved on a PC can be played back using Windows Media® Player or other suitable video players.
- Depending on the status of the SD card or Windows Media Player, you may not be able to play back H.264 videos.

## Playing back videos

**NOTE!**

- Depending on your network environment, downloading of videos may fail. If playback is in progress, it may be possible to download it by performing it again after stopping playback.
- Depending on the network environment and the camera status, you may not be able to perform each operation continuously on this screen.

## Operation

### Playing back images/video streams from the SD card

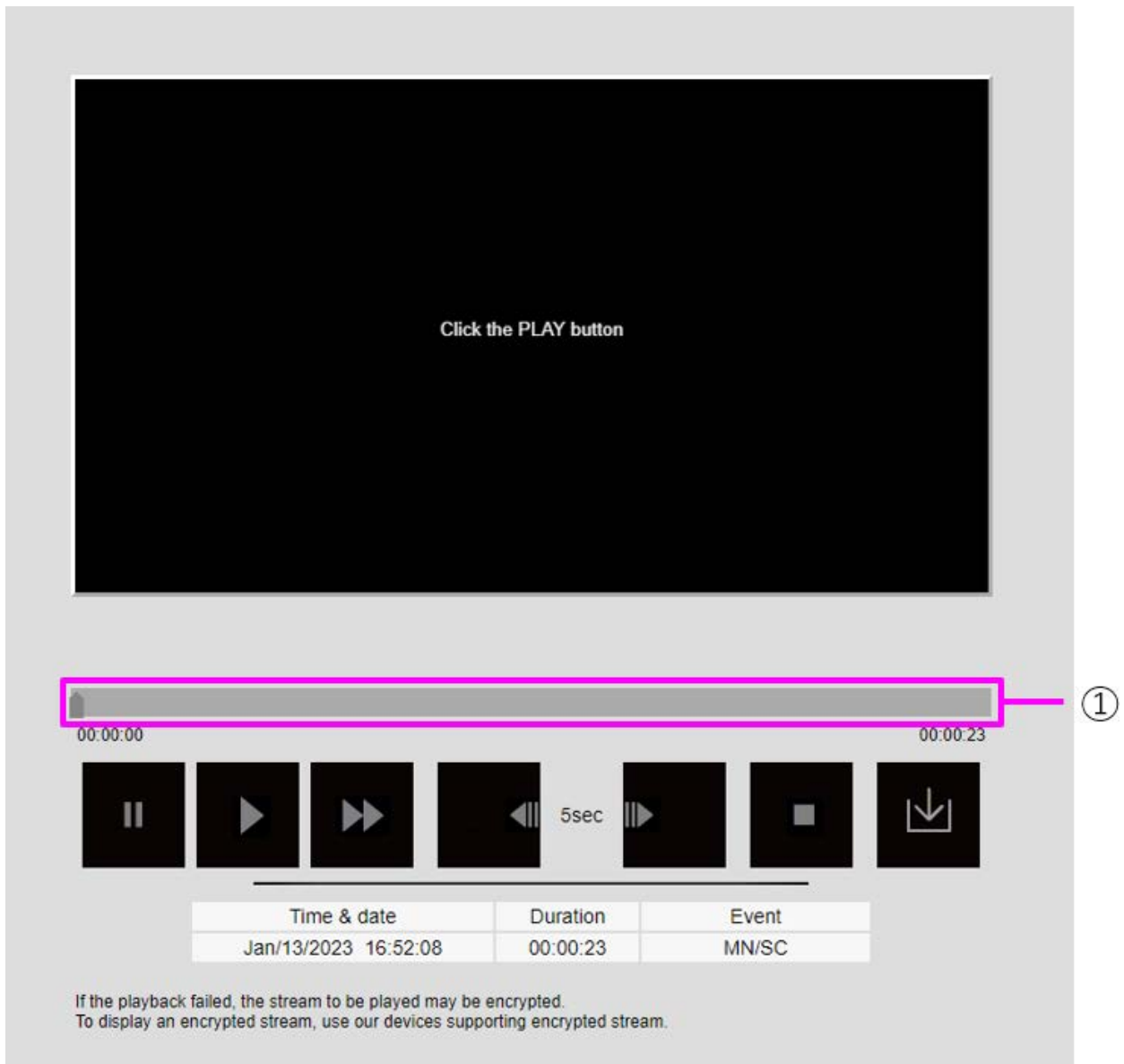

## ① Slider bar

You can press the slider bar and play it from any position. Operation is available only before start of playback, during pause, and after completion of playback.

### NOTE!



Move the slider bar to the I-picture at the position where you move it. For this reason, if streams with **GOP control** set to **Advanced (fixed GOP 60s + 1s keyframe)** are recorded, the movable position will be 60 seconds apart.

▮ **Pause** button: Click to pause/resume playback.

▶ **Play** button: Starts regular playback.

**NOTE!**

- When audio data is recorded, the recorded data is also played, but the image and sound are not synchronized. Therefore, there may be a slight deviation between the image and sound. During recording to the SD card, audio playback may be interrupted or sound quality may deteriorate.
- When playing back recorded data, the image updating speed of live videos or playback may be slow.
- If the **Audio transmission mode** in the **Audio** tab of the video/audio pages is **Off** or **Interactive(Half-duplex)**, the recorded data will not be played.

 **Fast playback** button: Click this button to increase the playback speed. During fast playback, click the  button to return to normal playback speed.

**NOTE!**

- The maximum speed of high-speed playback depends on the setting of **Stream recording > Max bit rate** on the SD card.
- During high-speed playback, the recorded data is not played.
- During high-speed playback, the display may be slowed or the display time may be skipped depending on the setting of **Stream recording > Max bit rate**.

 **Backward five seconds** button: Click the button to jump back by five seconds and resume reverse playback.

**NOTE!**

If streams with **GOP control** set to **Advanced (Fixed GOP 60s + 1s keyframe)** are recorded, the playback position may be returned for more than 5 seconds depending on the length of time the I picture is recorded.

 **Forward five seconds** button: Click the button to jump forward by five seconds and resume playback.

**NOTE!**

When the streams set to **Advanced (fixed GOP 60s + 1s keyframe)** in **GOP control** are recorded, the playback position may be returned depending on the length of time the I picture is recorded.

 **Exit** button: Exit the playback and return to the live image page.

**Time & data:** Displays the date and time the log was recorded.

**Duration:** Displays the time when the data is saved on the SD card.

**Event:** Displays the cause of the log.

## Operation

### Playing back images/video streams from the SD card

---

- MN/SC: logs saved manually and saved in schedule
- TRM1: Alarm due to alarm input to terminal 1
- TRM2: Alarm caused by alarm input to terminal 2
- TRM3: Alarm caused by alarm input to terminal 3
- VMD: Alarm due to operation detection alarm SCD: Alarm due to screen change detection alarm
- COM: Command Alarm
- AT: Alarm due to automatic tracking alarm
- INT: Intrusion alarm by AI-VMD
- LOI: Alarm on AI-VMD

#### NOTE!

The content displayed in **Event** depends on the camera model

 **Download** button: The selected image is downloaded to the PC (download folder as set in the browser settings).

#### NOTE!

- During download, the playback screen cannot be operated. Operation should be completed after downloading.
- If **Cancel** is clicked during download, the download will be canceled. The video data downloaded prior to clicking **Cancel** is saved to the computer.
- If the video data is larger than approx. 60 MB, the camera will split it into chunks of that size.
- H.264 videos saved on a PC can be played back using Windows Media® Player or other suitable video players.
- Depending on the status of the SD card or Windows Media Player, you may not be able to play back H.264 videos.

## Basic settings

This section contains the following information:

<b>The Configuration panel</b> .....	<b>94</b>
<b>Basic settings</b> .....	<b>96</b>
<b>Stream settings</b> .....	<b>98</b>
<b>Image quality settings</b> .....	<b>100</b>
<b>Zoom settings (EX zoom)</b> .....	<b>101</b>
<b>Audio settings</b> .....	<b>102</b>
<b>Alarm settings</b> .....	<b>103</b>
<b>Switching to Detailed settings for displayed images</b> .....	<b>104</b>

## Basic settings

### The Configuration panel

---

This chapter explains the items that can be set from the camera's live image. You can set general items for each function in live pictures.

- For how to display live pictures, refer to [→Viewing images from a PC, p. 40](#).
- For details on how to set each item from the **Detailed settings** menu, refer to [→Detailed settings, p. 107](#).

## The Configuration panel

The main settings of the camera are made on the Setup panel.

### NOTE!

Configuration panels can only be operated by users with **1. Administrator** access levels. For details on how to set the access level, refer to the following.

[→Configuring user authentication, p. 293](#)

## Accessing the configuration panel

- Live image pages are displayed.  
[→View camera images, p. 42](#)
- On live image pages, click the  button to display the setting panel.  
Press again to hide it. For more information on this panel, please refer to the following.  
[→Setting the Panel Screen, p. 95](#)

## Editing the configuration

Click on each tab in the Settings panel.

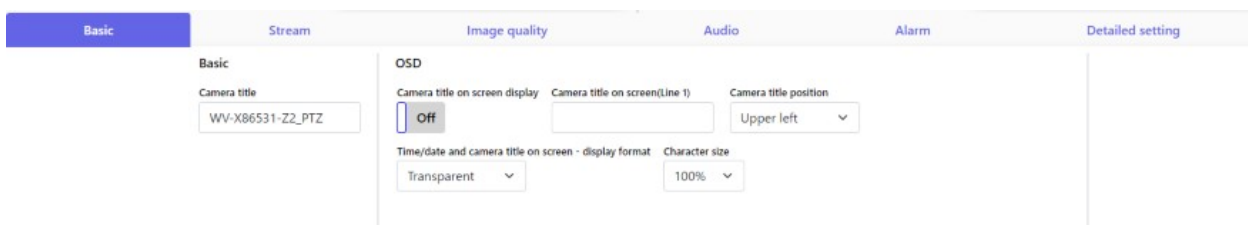

The screenshot shows the configuration panel with the following settings:

Basic	Stream	Image quality	Audio	Alarm	Detailed setting
<b>Basic</b> Camera title WV-X86531-Z2_PTZ		<b>OSD</b> Camera title on screen display: <input type="checkbox"/> Off Camera title on screen(Line 1): <input type="text"/> Camera title position: Upper left <input type="button" value="v"/> Time/date and camera title on screen - display format: Transparent <input type="button" value="v"/> Character size: 100% <input type="button" value="v"/>			

Enter each item on the setting page.

**NOTE!**

Some items cannot be set depending on the main area display.

If the desired item is not displayed, click on  or press the scroll bar to display the items you want to set.

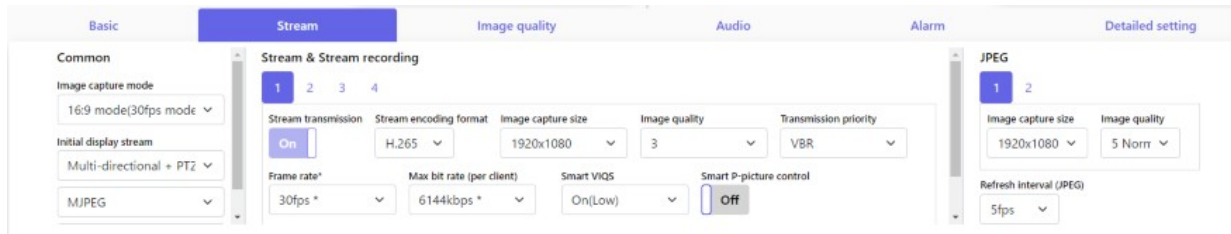

Once the entry is complete, click to confirm the entry if **Set** is available. Otherwise, it is confirmed when the set value is selected.

**NOTE!** If there are several buttons in the **Set**, **Register**, and **Execute** pages, click the **Set**, **Register**, and **Execute** button for each item.

## Setting the Panel Screen

### PTZ camera

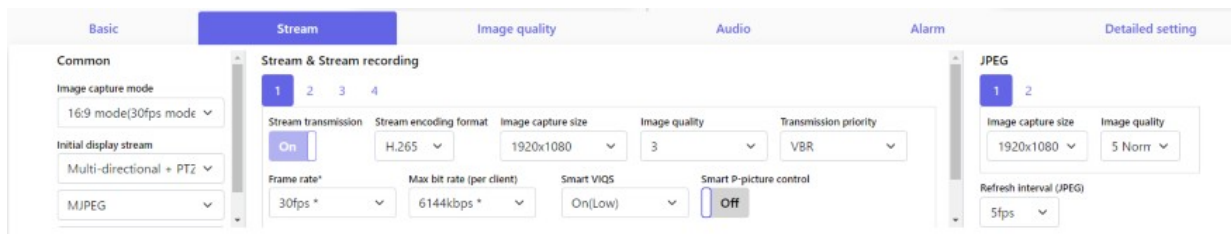

### Multisensor camera

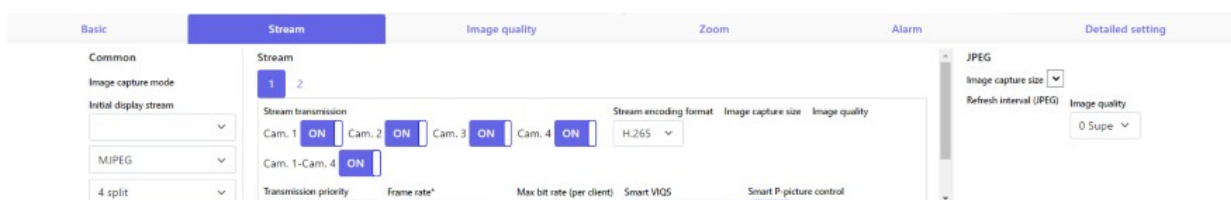

#### ① Basic tabs

On the **Basic** tab, you can set the camera titles and display characters.

→[Basic settings, p. 96](#)

## ② Stream tabs

On the **Stream** tabs, you can set up imaging modes, JPEGs, streams, etc.

→[Stream settings, p. 98](#)

## ③ Image quality tabs

On the **Image quality** tabs, you can set the image quality.

→[Image quality settings, p. 100](#)

## ④ Zoom tabs

On the **Zoom** tab, you can set zooming and other settings.

→[Zoom settings \(EX zoom\), p. 101](#)

→[Adjusting the zoom/focus, p. 205](#)

## ⑤ Audio tabs

The **Audio** tabs configure audio-related settings.

→[Audio settings, p. 102](#)

## ⑥ Alarm tabs

The **Alarm** tabs configure the alarm settings.

→[Alarm settings, p. 103](#)

## ⑦ Detailed setting tabs

On the **Detailed setting** tabs, you can migrate to **Detailed settings** menus and set up control panels.

→[Switching to Detailed settings for displayed images, p. 104](#)[displayed images](#)

# Basic settings

The **Basic** tabs set the camera titles and display settings. See the **Basic** tabs on the Advanced Basic Page for a detailed explanation of the settings and notes for settings.

→[Basic setup of the camera, p. 147](#)



## Basic

Set basic items such as camera title.

### Camera title

Enter the name of the camera. The entered name is displayed in the camera title.

**NOTE!**

**Image rotation** according to a camera's settings in **Date and time** and **Characters on Screen**.

## Date and time and Characters on screen

Specify the display position and size of the character string to be displayed on the screen.

### Camera

Select from **Camera 1** to **Camera 4** to individually set the following items for the selected camera.

#### Image rotation

ON/OFF is used to set whether to rotate the image.

**NOTE!** Depending on the camera model, you may not be able to set image rotation.

#### Camera title on screen display

Use **On/Off** to set whether the strings are displayed on the images.

When set to **On**, the character strings entered in **Camera title on screen** are displayed at the position selected in **Position**.

#### Camera title on screen(Line 1) / Camera title on screen(Line 2)

Enter a character string to be displayed in the image.

#### Camera title position

Select the position where the character string is displayed in the image.

#### Time/date and camera title on screen - display format

Sets the display format to either **Permeation** or **Opaque**.

#### Character size

Select the date and time displayed in the image and the character size of the character string.

## Installation position

### Tilt adjustment lever position

Set **Tilt adjustment lever position** to the same position you selected when installing the camera.

## Stream settings

The **Stream** tabs configure settings for JPEG, H.265, and H.264 images.

For a detailed explanation of the settings and notes for setting, refer to the **Image** tabs on the image/audio pages in the detailed settings.

→[Setting image modes, p. 172](#)

## Common

Set the common items for JPEG and stream.

### Image capture mode

Select the image to be displayed on the live image, etc.

### Initial display stream

Select the image to be displayed on the live image page.

## Stream

Select the number of the stream and set the **Stream transmission**.

### Stream transmission

On/Off sets whether to deliver H.265 (or H.264) images.

### Stream encoding format

Select the compression method for the stream to be delivered.

### Image capture size

Select the resolution of the H.265 (or H.264) image.

**Image quality**

Select the quality of the H.265 (or H.264) image.

**Transmission priority**

Set the stream delivery mode.

**Frame rate**

Sets the frame rate.

**Max bit rate (per client)**

Select the H.265 (or H.264) bit rate for one client.

**Auto VIQS**

Images are distributed so that the quality of images in moving places is high and the amount of data in other places is low.

**Smart VIQS**

Images are distributed so that the amount of data decreases while maintaining high image quality in areas with objects (head, people, cars and motorcycles) and low/medium/medium image quality in other areas.

**Smart P-picture control**

To reduce the amount of data, control the generation of data (macroblock) as little as possible except where there is an object (head, person, car, or motorcycle).

**GOP control**

The GOP control reduces the amount of data.

## JPEG

Configure the JPEG **Image capture size****Image quality****Transmission interval**.

**Image capture size**

When displaying JPEG images, select the resolution of the images to be displayed.

**Image quality**

Set the quality of JPEG images at each resolution.

**Refresh interval (JPEG)**

Select the rate at which the JPEG image is updated from the following.

# Image quality settings

For a detailed explanation of the settings and notes for setting, refer to the **Image quality** tabs on the image/audio pages in the detailed settings.

→[Configuring image quality, p. 187](#)

## Image quality

You can set various image quality adjustments such as brightness and sharpness level.

### NOTE!

- **Camera selection** is only available for Multisensor cameras.
- This item is not displayed when **Image capture mode** is in Quad mode.
- For **Common(Cam. 1-2)**, **Super Dynamic**, **Light control mode**, **White balance**, and **Intelligent Auto** can be set only for items that have not been developed in detail. To perform other **Detailed settings** menus, select each camera.

### Camera selection

Select the camera to set the image quality.

- **Common(Cam. 1-2)**: Sets the same settings for the cameras.
- **Camera 1**: Sets camera 1 image quality.
- **Camera 2**: Sets camera 2 image quality.
- **Camera 3**: Sets the image quality of camera 3.
- **Camera 4**: Sets camera 4 image quality.

### Brightness

Adjust the brightness.

Move the slider bar in the + direction to brighten the image. Move the slider bar in the - direction to darken the image. Press **Reset** to return to the default brightness.

### Sharpness level

Adjust the sharpness level (contour correction).

Moving the slider bar in the direction of + results in a sharp contour, and moving the slider bar in the direction of - results in a soft contour.

Press **Reset** to return to the default settings.

### Maximum gain

Adjust the maximum gain. When the subject's illumination becomes dark, the gain automatically increases and the screen brightens.

Increasing the gain may increase the noise.

Move the slider bar in the + direction to increase the maximum gain. Move the slider bar in the - direction to reduce the maximum gain. Press **Reset** to return to the default settings.

### Digital noise reduction

The digital noise reduction function automatically reduces noise at low illumination levels. Move the slider bar in the direction of + to increase the effect of noise reduction. There may be a lot of afterimages.

Moving the slider bar in the direction of - reduces the noise reduction effect. There are fewer aftereffects.

Press **Reset** to return to the default settings.

### Super Dynamic

On/Off is used to specify whether or not the super dynamic function can be activated.

### Light control mode

Select the mode to control the light intensity.

### Maximum shutter

The maximum exposure time adjusts the maximum storage time of the sensor.

### D&N

Select the mode for switching between black and white images and color images.

### Intelligent Auto

Set ON/OFF whether the intelligent auto function is enabled or not.

## Zoom settings (EX zoom)

On the **Zoom** tab, you set the angle of view of the image displayed during zooming.

For a detailed explanation of the settings and notes for setting, refer to the **Image quality** tabs on the image/audio pages in the detailed settings.

→[Adjust the angle of view with the EX zoom, p. 204](#)

## Zoom

Set the field of field of field.

### Camera selection

Select the camera to set EX zoom.

### Extra zoom

-: Zoom out of the image (increase **Wide angle**) by a zoom factor of 1.

**x1**: Show unzoomed image (zoom factor 1.0).

+: Zoom into the image (increase **Tele**) by a zoom factor of 1.

## Audio settings

The **Audio** tabs configure audio-related settings.

For a detailed explanation of the settings and notes for setting, refer to the **Audio** tabs on the image/audio pages in the detailed settings.

→[Configuring audio options, p. 224](#)

## Audio

Sets sound and volume items.

### Mic input volume

Set the volume of sound input to the camera. This setting is reflected in the volume of sound (listening) on the camera and the volume at **Audio recording**.

### Audio transmission mode

Set the communication mode for sending/receiving voice data between the camera and your computer.

### Audio input encoding format

Select the compression method for the earpiece sound.

### Audio volume control mode

Select how to use the volume cursor of the earpiece button on the live picture page.

# Alarm settings

The **Alarm** tabs configure the alarm settings.

See the **Alarm** tabs on the alarm pages for detailed explanations of setting values and notes for setting values.

→[Alarm settings, p. 103](#)

## Alarm

Set terminal operation and alarm items.

### Terminal 1

Set the operation of terminal 1.

### Terminal 2

Set the operation of terminal 2.

### Terminal 3

Set the operation of terminal 3.

### VMD alarm

ON/OFF is used to specify whether or not to perform operation detection.

When set to **On**, the entire area is specified in the operation detection area. To specify an arbitrary action detection area, set it on the **VMD area** tab of the alarm page of the **Detailed settings** menu.

→[Configuring motion detection using VMD areas, p. 271](#)

The **VMD area** tabs on the advanced alarm pages are accessible from live picture links.

### Scene change detection (SCD) alarm

ON/OFF is used to specify whether or not to perform screen change detection.

When set to **On**, the entire area is specified in the screen change detection area. To specify an optional screen change detection area, use the **SCD area** tabs on the alarm pages in Advanced Settings.

→[Configuring screen change detection using SCD areas, p. 281](#)

The **SCD area** tabs on the advanced alarm pages are accessible from live picture links.

### Audio detection alarm

ON/OFF is used to specify whether or not to perform sound detection.

When set to **On**, all AI sounds are enabled. To configure the details of sound detection, use the **Audio detection** tabs on the alarm pages in Advanced Settings.

## Basic settings

### Switching to Detailed settings for displayed images

---

→[Configuring audio detection, p. 285](#)

The **Audio detection** tabs on the advanced alarm pages are accessible from live picture links.

#### Alarm deactivation time

Sets the time when the alarm is detected and the detection operation is not executed. For example, if you set up an email notification to a mobile terminal or a tablet terminal using an alarm, this setting prevents you from sending too much email.

# Switching to Detailed settings for displayed images

## Ext. software

Displays the menu for managing the function extension software and setting the schedule.

→[Function extension software, p. 115](#)

## Network

The Network Settings menu is displayed.

→[Configuring the network, p. 309](#)

## Maintenance

This displays menus for checking the system log, software version upgrade, status check, and initialization of the camera settings.

→[Camera maintenance, p. 350](#)

## Camera detailed settings

Shows the detailed settings menu for configuring the camera.

→[Detailed settings, p. 107](#)

## Screen setting

### Operation panel layout

Select the position of the control panel from **Right**, **Left**, and **Bottom**.



→About live image pages, p. 44



## Detailed settings

This section contains the following information:

<b>About network security</b> .....	<b>108</b>
<b>The camera settings menu</b> .....	<b>109</b>
<b>Function extension software</b> .....	<b>115</b>
<b>Using Easy Setup</b> .....	<b>124</b>
<b>Basic setup of the camera</b> .....	<b>147</b>
<b>Configuring image and audio options for recordings</b> .....	<b>172</b>
<b>Setting the PTZ options</b> .....	<b>227</b>
<b>Working with alarms</b> .....	<b>258</b>
<b>Managing users</b> .....	<b>293</b>
<b>Configuring the network</b> .....	<b>309</b>
<b>Using schedules</b> .....	<b>345</b>
<b>Camera maintenance</b> .....	<b>350</b>
<b>Support</b> .....	<b>360</b>

# About network security

## Security function of the unit

This machine is equipped with the following security functions.

### ① Restricting access by user/host authentication

Setting **On** in User Authentication/Host Authentication can restrict the users accessing the cameras.

→[Configuring user authentication, p. 293](#)

→[Configuring host authentication, p. 296](#)

### ② Access restrictions due to HTTP port changes

You can prevent unauthorized access, such as port scanning, by changing the HTTP port number.

→[Basic network settings, p. 309](#)

### ③ Encryption of Access by HTTPS Function

By using the HTTPS function, you can encrypt the access to the camera and increase the security of communication.

→[Configuring HTTPS, p. 330](#)

### ④ Falsification detection

By using the falsification detection function, you can detect falsification of data recorded on the SD card.

→[Detecting tampering, p. 165](#)

### ⑤ SRTP communication

By using SRTP communication, the streaming data of the video data is encrypted in SSL, thus preventing peeps in the ID/PW.

→[Configuring SRTP, p. 338](#)

## ⑥ IEEE 802.1X Network Access Control

IEEE 802.1X Network Access Controls prevent unauthorized access and eavesdropping by connecting a malicious PC to a free switching hub port in a LAN.

→[Configuring IEEE 802.1X, p. 298](#)

### NOTE!

- Image data, authentication information (user name, password), alarm mail information, DDNS server information, etc. may be leaked on the network. Take measures such as restricting access by user authentication or encrypting access by HTTPS.
- After the administrator has accessed the camera, be sure to close all browsers to enhance security.
- Change the password of the administrator periodically to enhance security.
- When using the SNMP feature in SNMPv1/v2, do not configure community names that you can easily guess. (e.g., public). The camera's status could be leaked on the network or used as a stepping stone for unauthorized access to other devices.
- If you fail user authentication (authentication error) eight or more times in 30 seconds from a device with the same IP address, you will not be able to access the camera for a while.

## The camera settings menu

The Setup menu contains the main settings of the camera.

### NOTE!

Only users with **1. Administrator** access levels are allowed to access the Setup menu. For details on how to set the access level, refer to the following.

→[Configuring user authentication, p. 293](#)

## Accessing the camera settings menu

1. Live image pages are displayed.  
→[View camera images, p. 42](#)
2. Display the **Basic settings** panel.

## Detailed settings

### The camera settings menu

---

3. Click the **Detailed setting** tabs.  
→The Settings menu buttons, p. 112

The screenshot displays the camera's settings interface. On the left is a vertical sidebar menu with the following items: 'Live', 'Setup', '+Ext. software', '-Easy Setup', 'Internet', 'Event action', '+Basic', '+Image/Audio', '+PTZ', '+Alarm', '+User mng.', '+Network', '+Schedule', '+Maintenance', and '+Support'. The 'Setup' tab is selected, and the 'Internet' sub-tab is active. The main content area shows the 'Internet' settings. The 'UPnP(Auto port forwarding)' option is set to 'Off'. The 'DDNS' section has a table with 'Area' and 'Service' columns, and a dropdown menu for 'Area' showing '--Select the service area--'. Below this is a 'Set' button. A message box states 'Recommended network setting for internet' and 'A setup suitable for internet environment is carried out.', with a 'Set' button below it.

UPnP(Auto port forwarding)		<input type="radio"/> On <input checked="" type="radio"/> Off
DDNS	Area	--Select the service area--
	Service	

Set

Recommended network setting for internet | A setup suitable for internet environment is carried out.

Set

## Editing the camera settings

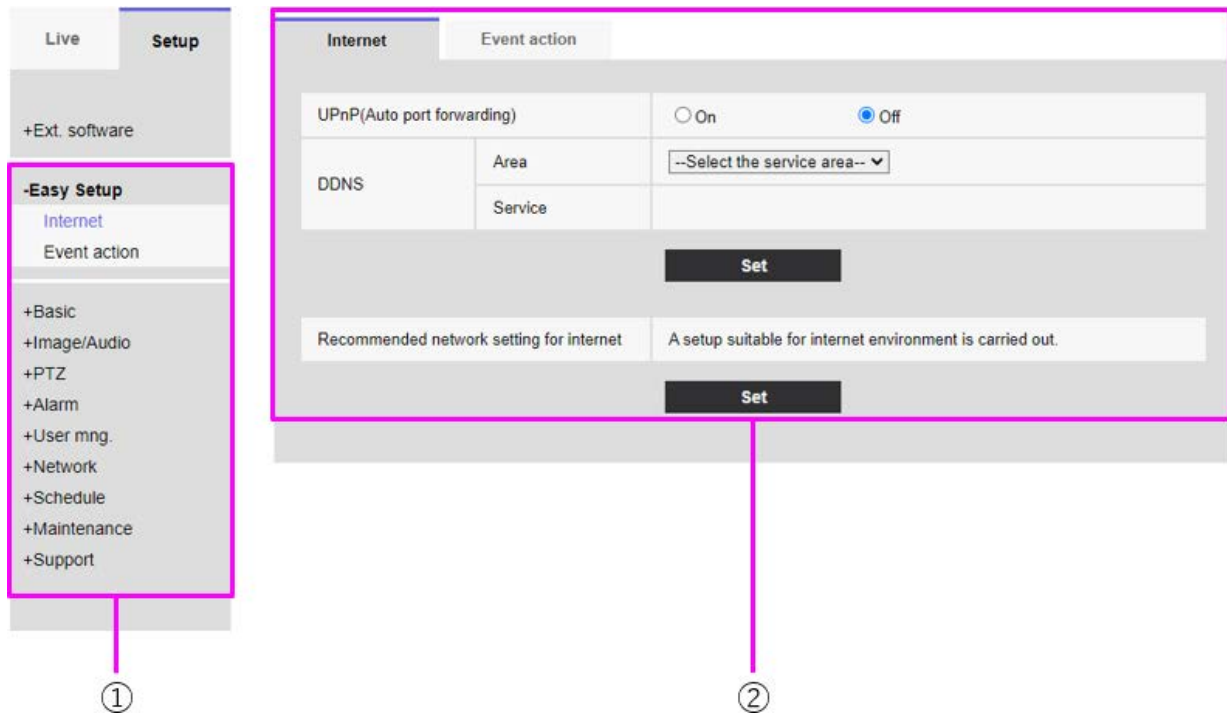

① Menu buttons, ② Configuration page

1. Click a menu button on the left side of the screen to display the setting page. If the page consists of more than one tab, click on each tab.
2. Enter each item on the setting page.
3. Once the entry is complete, confirm the entry by clicking **Set**.

**NOTE!** If there are several buttons in the **Set**, **Register**, and **Execute** pages, click the **Set**, **Register**, and **Execute** button for each item.

## Detailed settings

### The camera settings menu

**Internet**    Event action

UPnP(Auto port forwarding)     On     Off

DDNS    Area: --Select the service area--    Service:

**Set**    A-1

Recommended network setting for internet    A setup suitable for internet environment is carried out.

**Set**    B-1

- When you have finished setting the items in field A, click **Set** (A-1) below field A.
- If you do not press the **Set** button (A-1) at the bottom of field A, the setting will not be confirmed.
- As above, when you have finished setting the items in Box B, click **Set** (B-1) below Box B.

## The Settings menu buttons

### PTZ camera

Network Camera  
WV-X86531-Z2\_PTZ    WV-X86531-Z2\_PTZ

Live    Setup

③ Ext. software

④ Easy Setup

⑤ **Basic**

Basic

SD memory card

Overlay image

⑥ Image/Audio

⑦ PTZ

⑧ Alarm

⑨ User mng.

⑩ Network

⑪ Schedule

⑫ Maintenance

⑬ Support

⑭

**Basic**    SD memory card    Overlay image    ⑮

Menu language: English

Camera title: WV-X86531-Z2\_PTZ

Date/time: Jan 16, 2023 15:19:03

Set PC time to the camera

Date/time display:  On     Off

Time display format: 24h

Date/time display format: Mmm/DD/YYYY

Date/time position: Upper left

Time & date

NTP: NTP >>

Time zone: (GMT+09:00) Osaka, Sapporo, Tokyo

Summer time(daylight saving): Out

Start time & date: Month Day Time

End time & date: Month Day Time



## Multisensor camera

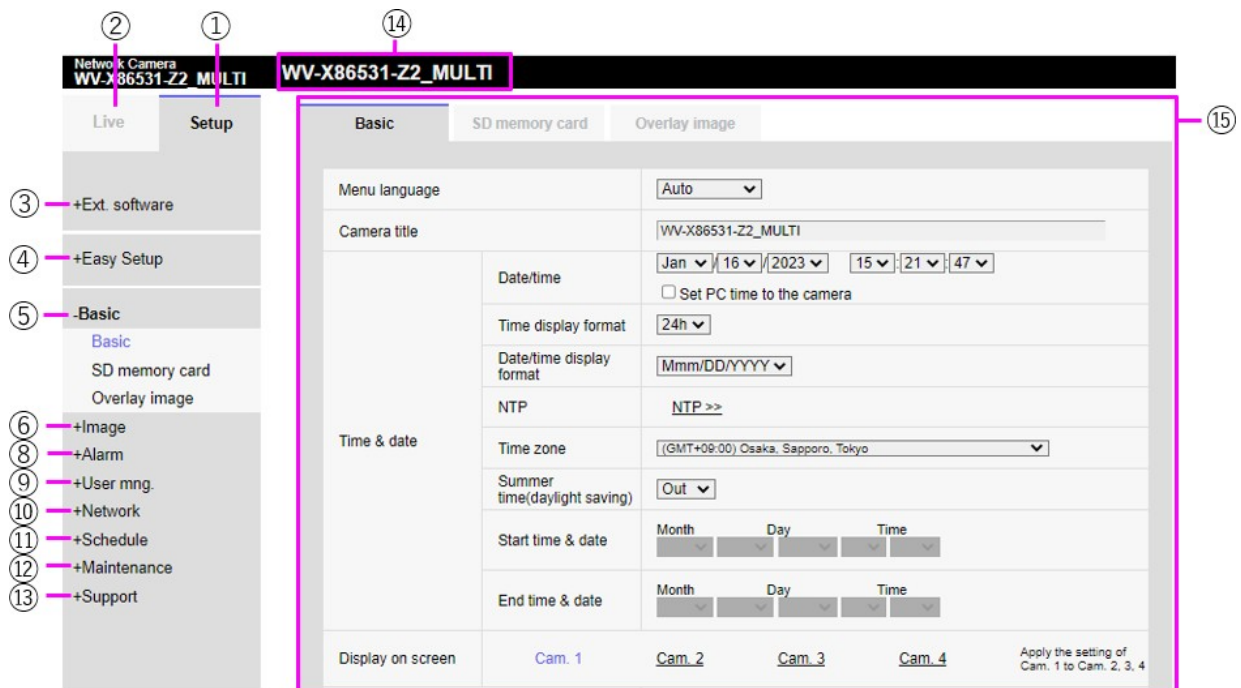

① **Setup** menu buttons

### ② **Live** button

Shows the live image page.

### ③ **Ext. software** button

You can manage the function extension software and set schedules. When the function extension software is installed, a link to the screen is displayed.

→[Function extension software, p. 115](#)

### ④ **Easy Setup** button

On the easy setting page, the event operation such as Internet disclosure setting, alarm setting and alarm linkage operation are set.

→[Using Easy Setup, p. 124](#)

### ⑤ **Basic** button

Basic pages set basic settings such as date and time, camera title, and information about the SD card.

→[Basic setup of the camera, p. 147](#)

#### ⑥ Image/Audio button

Image/Audio pages configure camera settings such as image quality and resolution for JPEG/H.265/H.264 images.

→[Configuring image and audio options for recordings, p. 172](#)

#### ⑦ PTZ button

On the PTZ page, settings are made for the home position and camera operations such as self-return.

→[Setting the PTZ options, p. 227](#)

#### ⑧ Alarm button

On the alarm page, the alarm operation and operation detection area are set, the screen change detection area is set, the sound detection alarm is set, and the alarm notification is set.

→[Working with alarms, p. 258](#)

#### ⑨ User mng. button

The User Management page is used to register authentication and configure data encryption to restrict users and PCs accessing the camera.

→[Managing users, p. 293](#)

#### ⑩ Network button

The network pages configure the network settings for your camera and the settings for DDNS (Dynamic DNS), SNMP (Simple Network Management Protocol), FTP/SFTP, NTP servers, UPnP, HTTPS, Qos, SRTP, and MQTT.

→[Configuring the network, p. 309](#)

#### ⑪ Schedule button

On the Schedule page, the schedule is set for operation detection permission, screen change detection permission, sound detection permission, etc.

→[Using schedules, p. 345](#)

#### ⑫ Maintenance button

On the Maintenance page, you can check the system log, upgrade the software version, check the status, and initialize the settings of the camera.

→[Camera maintenance, p. 350](#)

### ⑬ Support button

The support pages show how to display our support websites.

→[Support, p. 360](#)

### ⑭ Camera title

Allows changing the camera title.

### ⑮ Settings page

Contains the configuration tabs of the setup menu button you clicked.

## Function extension software

The **Ext. Software** page manages the function extension software and sets the operation schedule. The Extension Software page consists of the **Software mng.**, **Operation sched.**, and **Control log** tabs.

#### NOTE!

- If the imaging modes are **16:9 mode(60fps mode)/16:9 mode(50fps mode)/4:3 mode(15fps mode)/4:3 mode(12.5fps mode)**, the function extension software cannot be used. The operation schedule of the function extension software during installation is also deleted.
- Depending on the type of extension software, the frame rate can be limited to up to 7.5 fps in 15 fps mode, up to 6.25 fps in 12.5 fps mode, up to 15 fps in 30 fps mode, and up to 12.5 fps in 25 fps mode.

## Using the AI-VMD function extension software

This camera includes the pre-installed and ready-to-use AI-VMD function extension software. It uses artificial intelligence to classify and count objects moving into detection areas or crossing counting lines. Please see the →[AI-VMD for object detection and counting, p. 370](#) section in the appendix on how to use this software.

## Installing, uninstalling, and upgrading extension software

Click on the **Software mng.** tab of the function extension software page. Please refer to the table below for the display and operation of the **Detailed settings** menu.

→Accessing the camera settings menu, p. 109

→Editing the camera settings, p. 111

### PTZ camera

Software mng.	Operation sched.	Control log
Unique information		
MPR ID	6800-0106-450D-9877	
Remaining ROM	85404 kbytes	
Remaining RAM	52404 kbytes	
SDK version	1.60	
Firmware version	Z0.0	
RAM capacity expansion mode	<input type="radio"/> On <input checked="" type="radio"/> Off	
<b>Set</b>		
<ul style="list-style-type: none"> <li>• When "On" is set for the RAM capacity expansion mode, the function to record on the SD memory card will become unavailable.</li> <li>• "Off" is unavailable when the remaining RAM capacity is less than 51200 kbytes.</li> <li>• Refer to the following URL for extension software required to set "On" for the RAM capacity expansion mode.</li> </ul> For use in Japan <a href="https://cwc.i-pro.com/pages/application-platform-list">https://cwc.i-pro.com/pages/application-platform-list</a> For use in a country other than Japan <a href="https://i-pro.com/global/en/surveillance/i-pro-application-platform/application-list">https://i-pro.com/global/en/surveillance/i-pro-application-platform/application-list</a>		
AI-VMD	<b>Uninstall</b>	
Software version	3.10	
Status	Operable	
Setup menu	<b>Setup &gt;&gt;</b>	
<div style="border: 1px solid #ccc; padding: 5px;"> <p>Choose File   No file chosen</p> <p> <input checked="" type="radio"/> Install new Ext. software           <input type="radio"/> AI-VMD... Upgrade         </p> <p style="text-align: right;"><b>Execute</b></p> <p>Use the latest edition of the extension software.</p> <p>Please wait and do not operate the browser during install.</p> </div>		
AI Processor Activation Key		
Register the Registration Key	<input type="text"/>	<b>Set</b>
*No dashes in between.		

## Multisensor camera

Software mng.

Operation sched.

Control log

Unique information	
MPR ID	6700-0106-450D-9876
Remaining ROM	109600 kbytes
Remaining RAM	4800 kbytes
SDK version	1.60
Firmware version	Z0.0

AI-VMD(Cam. 1)	<b>Uninstall</b>
Software version	2.30/SDK1.40
Status	Operable
Setup menu	<b>Setup &gt;&gt;</b>

AI-VMD(Cam. 2)	<b>Uninstall</b>
Software version	2.30/SDK1.40
Status	Operable
Setup menu	<b>Setup &gt;&gt;</b>

AI-VMD(Cam. 3)	<b>Uninstall</b>
Software version	2.30/SDK1.40
Status	Operable
Setup menu	<b>Setup &gt;&gt;</b>

AI-VMD(Cam. 4)	<b>Uninstall</b>
Software version	2.30/SDK1.40
Status	Operable
Setup menu	<b>Setup &gt;&gt;</b>

Choose File

No file chosen

Install new Ext. software **Execute**

Cam. 1 ▼

- AI-VMD(Cam. 1)...Upgrade
- AI-VMD(Cam. 2)...Upgrade
- AI-VMD(Cam. 3)...Upgrade
- AI-VMD(Cam. 4)...Upgrade

Use the latest edition of the extension software.

Please wait and do not operate the browser during install.

AI Processor Activation Key	
Register the Registration Key	Registered

## Installing function extension software

1. Save the function extension software to be installed on the PC.

#### NOTE!

Check **Remaining ROM** and **Remaining RAM** (see [Camera-specific data, p. 119](#) for ROM/RAM capacity).

2. Click on **Choose File** and select the \*.ext file you downloaded.
3. Select the camera for which you want to install the software.

#### NOTE!

Selecting cameras is only available for Multisensor cameras not running in Quad mode.

4. Make sure that **Install new Ext. software** is selected and press **Execute**. When the installation has finished successfully, the **Software mng.** window shows the name of the installed software.

#### NOTE!

- Do not use spaces or double-byte characters in the name of the source folder.
- Use the specified file (ext file) for the function extension software.
- Do not turn off the camera during installation.
- Do not perform any operation during installation until the installation is completed.
- Installation of the function extension software is performed only on the selected camera.
- <Multisensor>: If you switch the imaging mode to Quad mode or from Quad mode to another mode, all function extension software will be uninstalled. Re-install the software in such a case.

## Software Management tab

If function extension software is installed, this tab shows the camera-specific data and the registration status of the software. The following operations can be performed on this screen.

- Uninstalling the function extension software
- Display of the detailed registration status screen
- Display of the setting screen of the function extension software
- Update of the function extension software

**NOTE!** The maximum number of software extensions that can be installed varies according to the camera model.

## Camera-specific data

### MPR ID

This ID is required to issue the license cancellation key number of the function extension software. The device has a unique device ID.

### Remaining ROM

Displays the ROM capacity for the function extension software remaining in the camera. If the function extension software to be installed requires more than the ROM capacity shown here, it cannot be installed.

### Remaining RAM

Displays the RAM capacity for the function extension software remaining in the camera. If the function extension software to be installed requires more RAM capacity than shown here, it cannot be installed.

Camera Part	ROM capacity	RAM capacity
<Multisensor>	150MB	200MB
<PTZ>	100MB	100MB

### SDK version

This displays the version information of the SDK installed in the camera. If the function extension software to be installed requires more than the version number displayed here, the function extension software may not work properly.

### Firmware version

The camera software version information is displayed. **RAM capacity expansion mode** Use **On/Off** to set whether to expand the RAM capacity.

#### NOTE!

- **RAM capacity expansion mode** can be selected only for models with RAM capacity extension.
- When **RAM capacity expansion mode** is set to **On**, this function disables the recording function to SD card.
- If **Remaining RAM** shows negative values, uninstall the extension or set **RAM capacity expansion mode** to **On**.
- Press **Set** to restart the camera. After restarting, the product cannot be operated for about two minutes as it was when the power was turned on.

## Function extension software

### <Function Extension Software Name>

The installed function extension software is displayed in the list. If the camera is installed separately, it is displayed as **Name of Function Extension Software (Camera Number)**.

#### NOTE!

<Multisensor>: Only the Multisensor camera displays the camera number.

## Uninstall buttons

You can uninstall the installed function extension software.

### Software version

When function extension software is installed, the version information of the installed function extension software and the version information of the SDK incorporated in the function extension software are displayed. If the version number of the SDK included in the camera is less than the version number required by the function extension software, the function extension software may not work properly.

#### NOTE!

If the function extension software does not include the SDK version information, the SDK version information is not displayed.

### Status

Displays the installation status of the function extension software. When **Operable** is displayed, it indicates that the installed function extension software is ready for operation.

### Setup buttons

When the function extension software has its own screen, such as the setting screen, the screen can be displayed.

## Install new extended software

Select this to install the new function extension software. Select the camera to be installed and the function extension software to be installed.

#### NOTE!

<Multisensor>: Only a Multisensor camera can be installed.



## Upgrading extension software

Select the function extension software that is already installed. You can upgrade the function extension software by clicking **Execute**.

### AI processor deactivation license

You can install and use the application software released from other companies using the AI processor on your camera.

## Scheduling extended software operation

Click on the **Operation sched.** tab of the function extension software page. Refer to the table below for how to display and operate the setting menu.

→[Accessing the camera settings menu, p. 109](#)

→[Editing the camera settings, p. 111](#)

## Detailed settings

### Function extension software

Software mng.**Operation sched.**Control log

AI-VMD ▾

**Operating day of week**

Day	Mon	Tue	Wed	Thu	Fri	Sat	Sun
Time table 1	<input checked="" type="radio"/>	<input checked="" type="radio"/>	<input checked="" type="radio"/>	<input checked="" type="radio"/>	<input checked="" type="radio"/>	<input checked="" type="radio"/>	<input checked="" type="radio"/>
Time table 2	<input type="radio"/>	<input type="radio"/>	<input type="radio"/>	<input type="radio"/>	<input type="radio"/>	<input type="radio"/>	<input type="radio"/>
Off	<input type="radio"/>	<input type="radio"/>	<input type="radio"/>	<input type="radio"/>	<input type="radio"/>	<input type="radio"/>	<input type="radio"/>

**[Time table 1]**

	0:00	6:00	12:00	18:00	24:00	Operation content
1	<input type="text" value="00"/> : <input type="text" value="00"/> - <input type="text" value="00"/> : <input type="text" value="00"/>					Off ▾
2	<input type="text" value="00"/> : <input type="text" value="00"/> - <input type="text" value="00"/> : <input type="text" value="00"/>					Off ▾
3	<input type="text" value="00"/> : <input type="text" value="00"/> - <input type="text" value="00"/> : <input type="text" value="00"/>					Off ▾
4	<input type="text" value="00"/> : <input type="text" value="00"/> - <input type="text" value="00"/> : <input type="text" value="00"/>					Off ▾
5	<input type="text" value="00"/> : <input type="text" value="00"/> - <input type="text" value="00"/> : <input type="text" value="00"/>					Off ▾
6	<input type="text" value="00"/> : <input type="text" value="00"/> - <input type="text" value="00"/> : <input type="text" value="00"/>					Off ▾

**[Time table 2]**

	0:00	6:00	12:00	18:00	24:00	Operation content
1	<input type="text" value="00"/> : <input type="text" value="00"/> - <input type="text" value="00"/> : <input type="text" value="00"/>					Off ▾
2	<input type="text" value="00"/> : <input type="text" value="00"/> - <input type="text" value="00"/> : <input type="text" value="00"/>					Off ▾
3	<input type="text" value="00"/> : <input type="text" value="00"/> - <input type="text" value="00"/> : <input type="text" value="00"/>					Off ▾
4	<input type="text" value="00"/> : <input type="text" value="00"/> - <input type="text" value="00"/> : <input type="text" value="00"/>					Off ▾
5	<input type="text" value="00"/> : <input type="text" value="00"/> - <input type="text" value="00"/> : <input type="text" value="00"/>					Off ▾
6	<input type="text" value="00"/> : <input type="text" value="00"/> - <input type="text" value="00"/> : <input type="text" value="00"/>					Off ▾

Set

Select the function extension software to set its operation schedule.

#### Operating day of week

Select **Time table 1****Time table 2****Off** for each day of the week.

#### Time table 1/Time table 2

To specify the time, click ▾ to set the time. 24-hour setting is available for **00: 00** to **00: 00**. You can configure **On/Off** in **Operation content**.

## How to set the schedule

1. From the list of function extension software, select the software for which the operation schedule is to be set.
2. In the **Operating day of week**, select the day of the week and the timetable that you want to schedule.
3. In **Time table 1** **Time table 2**, specify the time zone to be operated. Specify **00: 00** to **00: 00** for 24-hour operation.
4. When you are finished, press **Set**.

## Checking the Control log of function extension software

Click on **Control log** to display the management log for the function extension software. Refer to the table below for how to display and operate the setting menu.

→[Accessing the camera settings menu, p. 109](#)

→[Editing the camera settings, p. 111](#)

Up to 200 management logs can be saved in the internal memory of the camera.

If the maximum number of management logs is exceeded, the oldest log will be overwritten by the new log.

100 management logs are displayed and saved even if the camera is turned off.

Software mng.	Operation sched.	Control log
1/2Page		
<< Previous 100		
Next 100 >>		
No.	Time & date	Description

### Next 100 items >>

Click to display the following 100 entries in the management log list that you are viewing.

### Page number display

The currently open page is displayed in the form **Page/Total Pages**.

### << Previous 100 items

Click to display 100 items in front of the displayed management log list.

### No

The serial number in the control log is displayed. **Time & date**

The date and time when the log occurred is displayed.

#### Description

Contains the contents of the management log.

## Using Easy Setup

The following settings can be made on the easy setting page.

- Configure alarm-based and periodic SD card recording.
- Configure alarm-based and periodic FTP transmission.

The easy configuration pages consist of the **Easy installation**, **Internet**, and **Event action** tabs.

## Configuring event actions

Select the **Event action** tab on the **Easy Setup** pages to view the current configuration. Refer to the table below for how to display and operate the setting menu.

→[Accessing the camera settings menu, p. 109](#)

→[Editing the camera settings, p. 111](#)

Internet    **Event action**

Configure the event action setting.  
Specify the action to be taken when an alarm is detected and register the action in the schedule in order.

[Current settings]

Alarm	
Alarm condition	Off
Alarm	Off
Output terminal	Off
E-mail notification	Off

Schedule	
Schedule	Off

[Notes]  
• When the operating condition is changed, some settings will be cancelled. Confirm the settings after completing the setup.

**Next**

In event operation, the event operation can be set for SD schedule recording, regular transmission of FTP/SFTP, and alarm detection.

**NOTE!**

- **FTP/SFTP periodic image transmission** can be selected only for models with FTP/SFTP features.
- Both **FTP/SFTP periodic image transmission** and **FTP/SFTP** can be operated simultaneously when an alarm is generated.

**Next button**

Click on **Next** to proceed.

## Event operation workflow

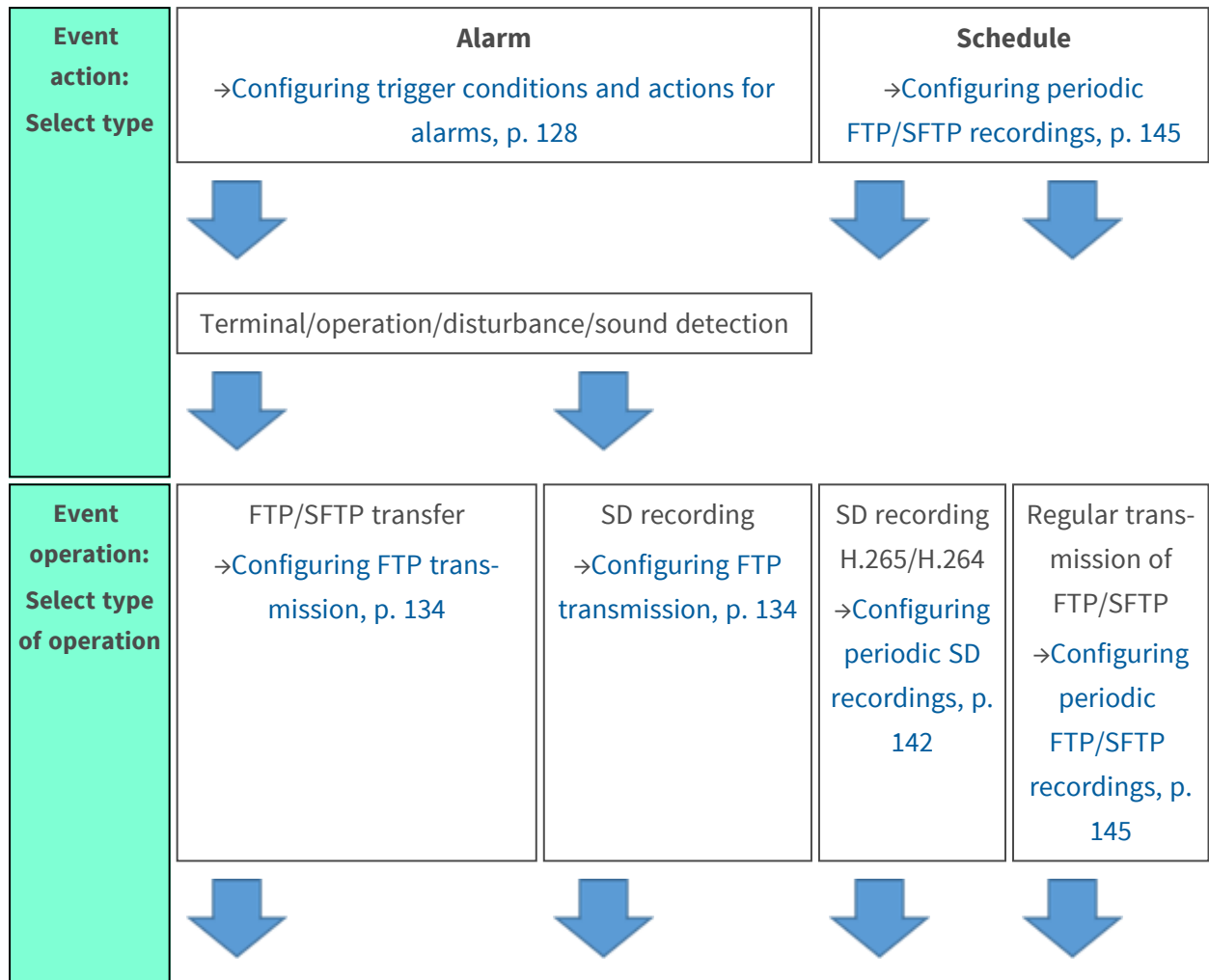

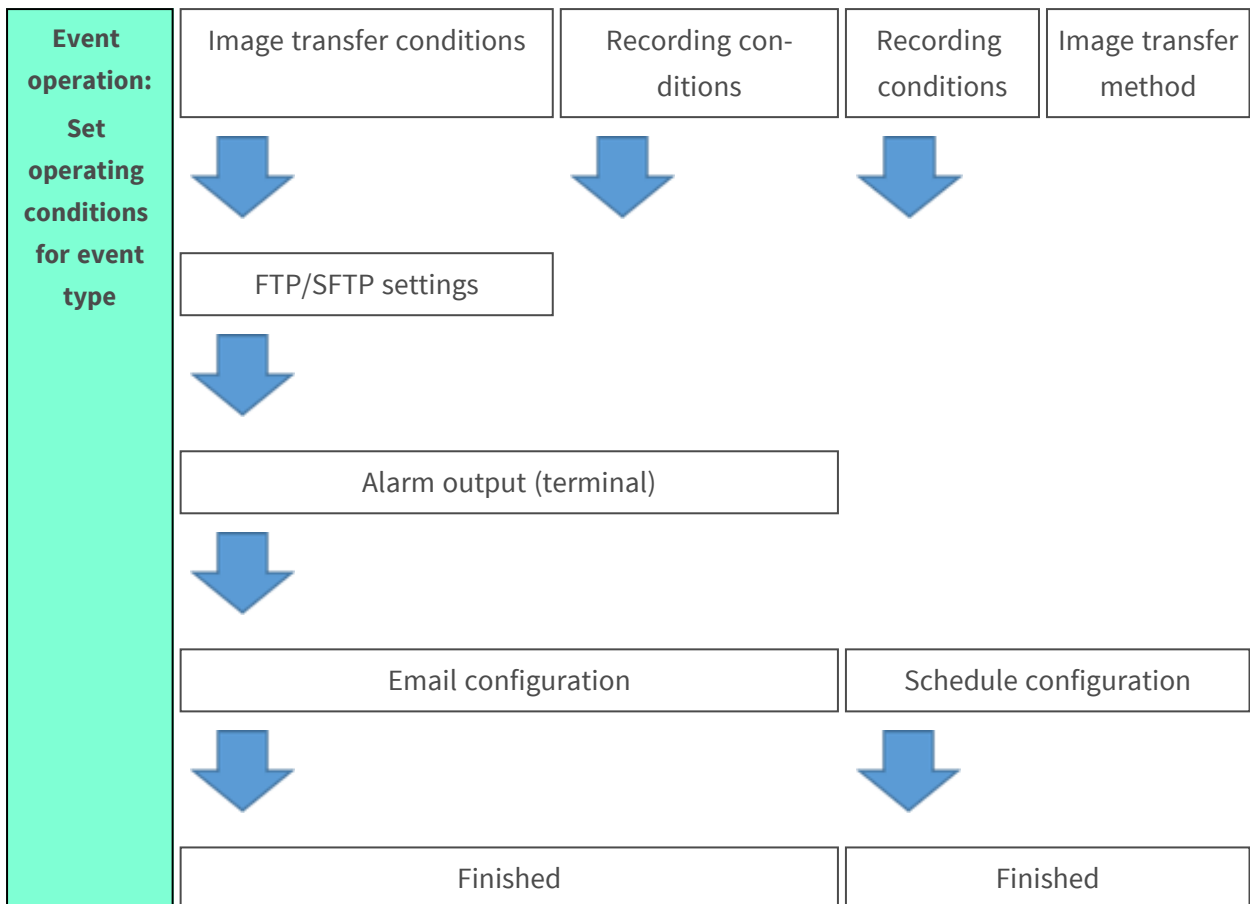
**NOTE!**

<Multisensor>: There is no FTP/SFTP function.

## Select event action (Alarm/Schedule)

Select the type of event action to be triggered on the **Event action** page.

Internet	Event action
<p>Select an event that triggers the event action. When it is needed to format the SD memory card, click the [Execute] button.</p>	
Trigger	Alarm ▼
SD memory card format	<b>Execute</b>
<div style="background-color: black; color: white; padding: 5px 20px; display: inline-block; margin-top: 10px;">Next</div>	

#### Trigger

- **Alarm:** Select to configure alarm actions.
- **Schedule:** Select to configure periodic FTP image transmission or SD recordings.

#### NOTE!

**FTP/SFTP periodic image transmission** can be selected only for models with FTP/SFTP features.

#### SD memory card format

To format the SD card, press **Execute**.

- Click on **Execute** to display the **Format** confirmation window.
- Press the **OK** button to start formatting.
- Press **X** to close the **Format Completion** window.

#### NOTE!

- Formatting will delete all data on the SD card.
- Do not turn off the power supply of the camera while formatting.

#### Next button

Select **Alarm** and press **Next** to open the **Alarm Settings** page.

→[Configuring trigger conditions and actions for alarms, p. 128](#)

Select **Schedule** and press **Next** to open the **Schedule Type Settings** page.

→[Scheduling FTP transfers/SD recordings, p. 141](#)[setting screen](#))

## Configuring trigger conditions and actions for alarms

This section sets the operation when an alarm is detected.



Internet
Event action

Set the alarm condition to be used for the alarm detection.  
 The whole area except the preset positions is to be set as the detection area for the motion detection alarm.  
 The motion detection area for each preset position can be set by configuring the settings for "VMD area" of "Alarm".  
 To move the camera to the preset position when an alarm is detected, configure the settings for "Alarm linkage action".  
 For SCD alarm, set all areas as the detection area.

Alarm	
Terminal 1	Off <span style="float: right;">▼</span>
Terminal 2	Off <span style="float: right;">▼</span>
Terminal 3	Off <span style="float: right;">▼</span>
VMD alarm	<input type="radio"/> On <input checked="" type="radio"/> Off
SCD alarm	<input type="radio"/> On <input checked="" type="radio"/> Off
Audio detection alarm	<input type="radio"/> On <input checked="" type="radio"/> Off
Alarm deactivation time	<input style="width: 50px;" type="text" value="5"/> s (5-600s)

Camera action on alarm	
Terminal alarm 1	Off <span style="float: right;">▼</span>
Terminal alarm 2	Off <span style="float: right;">▼</span>
Terminal alarm 3	Off <span style="float: right;">▼</span>
VMD alarm	Off <span style="float: right;">▼</span>
SCD alarm	Off <span style="float: right;">▼</span>
Audio detection alarm	Off <span style="float: right;">▼</span>

Back
Next

## “Alarm” section

Set the conditions that trigger an alarm in this section.

### Terminal *n*

Set the alarm conditions for terminal *n* (where  $n=1$  to 3).

- **Off:** Terminal function is not used.
- **Alarm input (TRM n):** Terminal alarm input is received.
  - **Close:** When the terminal status changes to **On**, an alarm is detected.
  - **Open:** When the terminal status changes to **Off**, an alarm is detected.
  - **Close (Continue):** When the terminal status changes to **On**, an alarm is detected. When the terminal status is **On**, the alarm is detected periodically at intervals of no alarm detection time.
  - **Open (Continue):** When the terminal status changes to **Off**, an alarm is detected. When the terminal status is **Off**, the alarm is detected periodically at intervals of no alarm detection time.
- **Black & white input:** Receives black-and-white selector input (when the input is **On**, the input is switched to black and white).
- **Auto time adjustment:** Time setting by terminal input is accepted.

When the signal is input, set to 00 minutes 00 seconds if the time difference from the normal time (00 minutes per hour) is 29 minutes or less. In the case of returning the time less than 5 seconds during SD recording, the time is not changed. Selecting Auto Time Adjustment displays the pull-down menu for short circuit and release selection.

  - **Close:** When the terminal status changes to **Close**, the automatic time adjustment is performed.
  - **Open:** When the terminal status changes to **Open**, the automatic time adjustment is performed.

#### VMD (Video Motion Detection) alarm

- **On:** If the motion detection area is not set, the entire area is set. To set the operation detection area, use the **VMD area** tab on the alarm page.  
→[Defining VMD areas for motion detection, p. 279](#)
- **Off:** Disables all operation detection status.

#### SCD (Scene Change Detection) alarm

- **On:** If the screen change detection area is not set, the entire area is set. To set up the screen change detection area, use the **SCD area** tab on the alarm page.  
→[Configuring screen change detection using SCD areas, p. 281](#)
- **Off:** Disables all screen change detection conditions.

### Audio detection alarm

- **On:** Use the sound detection alarm. All AI sounds are recognized.  
→[Configuring audio detection, p. 285](#)
- **Off:** Sound detection alarm is not used.

### Alarm deactivation time

Sets the time when the alarm is detected and the detection operation is not executed. For example, if you set up an email notification to a mobile terminal or a tablet terminal using an alarm, this setting prevents you from sending too much email.

**NOTE!**

Alarm detection time is managed for each alarm type. For example, the operation detection alarm is detected even when the alarm of terminal alarm 1 is not detected.

### “Camera action on alarm” section

Select the camera actions for alarms activated in the “[Alarm](#)” section, p. 129.

### Terminal alarm *n*

Sets the camera action triggered by terminal *n* (where *n*=1 to 3).

- **Off:** No action.
- **1~256:** The camera moves to the selected position.

**NOTE!**

Only if the selected preset position has been registered!

→[Setting preset positions, p. 234](#)

- **Patrol *n*:** Starts the selected camera patrol.

**NOTE!**

Only if the selected camera patrol has been registered!

→[Configuring patrol patterns, p. 243](#)

### VMD alarm

Sets the camera action triggered by the motion detector from the following.

## Detailed settings

### Using Easy Setup

---

- **Off:** No action.
- **1~256:** The camera moves to the selected position.

**NOTE!**

Only if the selected preset position has been registered!

→[Setting preset positions, p. 234](#)

- **Patrol *n*:** Starts the selected camera patrol.

**NOTE!**

Only if the selected camera patrol has been registered!

→[Configuring patrol patterns, p. 243](#)

### SCD alarm

Sets the camera action triggered by the scene change detector from the following.

- **Off:** No action.
- **1~256:** The camera moves to the selected position.

**NOTE!**

Only if the selected preset position has been registered!

→[Setting preset positions, p. 234](#)

- **Patrol *n*:** Starts the selected camera patrol.

**NOTE!**

Only if the selected camera patrol has been registered!

→[Configuring patrol patterns, p. 243](#)

### Audio detection alarm

Sets the camera action triggered by sound detection from the following.

- **Off:** No action.
- **1~256:** The camera moves to the selected position.

**NOTE!**

Only if the selected preset position has been registered!

→[Setting preset positions, p. 234](#)

- **Patrol *n***: Starts the selected camera patrol.

**NOTE!**

Only if the selected camera patrol has been registered!

→[Configuring patrol patterns, p. 243](#)

**Next button**

Click on **Next** to proceed.

**Back button**

Click on **Back** to return to the previous page.

## Triggering file transfers/SD recordings upon detecting an alarm

In the **Alarm type** window, select the action that will be triggered if the camera detects an alarm.

**Trigger**

- **FTP/SFTP Transfer**: Transfers JPEG images via FTP/SFTP when the camera detects an alarm.  
→[Configuring FTP transmission, p. 134](#)
- **SD memory recording**: Records to SD card when the camera detects an alarm.
  - JPEG images: →[Configuring SD card recording of JPEG images, p. 136](#)
  - H.265/H.264 video: →[Configuring SD card recording of H.265/H.264 video, p. 136](#)

**NOTE!**

- **FTP/SFTP periodic image transmission** can be selected only for models with FTP/SFTP features.
- **FTP/SFTP Transfer** and **FTP/SFTP periodic image transmission** can both be set (when both actions take place at the same time, **FTP/SFTP Transfer** takes precedence).

## Detailed settings

### Using Easy Setup

---

#### Recording format

When **SD memory recording** is selected in **Trigger**, select the compression method for the images to be recorded as JPEG images or stream.

#### Next button

Click on **Next** to proceed.

#### Back button

Click on **Back** to return to the previous page.

#### Configuring FTP transmission

Configure the FTP/SFTP transfer specifics in this window.

Internet	Event action
Set the method of image transmission to the FTP/SFTP server when an alarm is detected.	
Transmission protocol	<input type="radio"/> FTP <input checked="" type="radio"/> SFTP
Alarm setting	
Alarm image transmission	<input type="radio"/> On <input checked="" type="radio"/> Off
Directory name	<input type="text"/>
File name	<input checked="" type="checkbox"/> Terminal 1 <input checked="" type="checkbox"/> Terminal 2 <input checked="" type="checkbox"/> Terminal 3 <input checked="" type="checkbox"/> VMD <input checked="" type="checkbox"/> SCD <input checked="" type="checkbox"/> Auto track <input checked="" type="checkbox"/> Audio detection <small>* For alarms by the "Ext. software", alarm images will be transmitted only by configuring the alarm image SFTP transmission.</small>
FTP transmission retry	<input type="radio"/> On <input checked="" type="radio"/> Off
Pre alarm	Transmission interval: <input type="text" value="1ips"/> Maximum number of images: <input type="text" value="0 pic"/> Recording duration: 0s
Post alarm	Transmission interval: <input type="text" value="1ips"/> Number of images: <input type="text" value="100 pics"/> Recording duration: 100s
Image capture size	<input type="text" value="JPEG(2)"/> (640x360)
SFTP server setting	
SFTP server address	<input type="text"/> Example of entry: 192.168.0.10
Control port	<input type="text" value="21"/> (1-65535)
FTP mode	<input checked="" type="radio"/> Passive <input type="radio"/> Active
<input type="button" value="Back"/> <input type="button" value="Next"/>	

For details on how to set up the above screen, refer to the following.

→[Configuring FTP/SFTP transmission function, p. 319](#)

### Next button

In the **Alarm Settings** window, do the following:

- Select **Alarm output** and press **Next** to configure the **Alarm Outputs**.  
→[Configuring alarm outputs, p. 138](#)
- Do not select **Alarm output** and press **Next** to configure the **Mail Settings**.  
→[Configuring email notification, p. 139](#)

## Detailed settings

### Using Easy Setup

---

#### Back button

Click on **Back** to return to the previous page.

### Configuring SD card recording of JPEG images

The SD recording (JPEG) for alarm detection is set here.

Internet	Event action
Configure the recording condition of the SD memory recording when an alarm is detected. Even if "Audio detection alarm" is set to "On", recording to the SD memory card will not be performed when the alarm occurs.	
JPEG recording(Alarm)	
File name	img_
Image saving interval/Number of images to be saved(Pre alarm)	Image saving interval: 1fps Number of images to be saved: Off
Image saving interval/Number of images to be saved(Post alarm)	Image saving interval: 1fps Number of images to be saved: 100 pics
<b>Back</b> <b>Next</b>	

See the **JPEG recording(Alarm)** below for instructions on how to set up the window above.

→SD card options, p. 154

#### Next button

In the **Alarm Settings** window, do the following:

- Select **Alarm output** and press **Next** to configure the **Alarm Outputs**.  
→Configuring alarm outputs, p. 138
- Do not select **Alarm output** and press **Next** to configure the **Mail Settings**.  
→Configuring email notification, p. 139

#### Back button

Click on **Back** to return to the previous page.

### Configuring SD card recording of H.265/H.264 video

Here, SD recording (H.265 or H.264) at alarm detection is set.



Internet	Event action
Configure the recording condition of the SD memory recording when an alarm is detected. Even if "Audio detection alarm" is set to "On", recording to the SD memory card will not be performed when the alarm occurs.	
Stream recording(Alarm)	
Audio recording	<input type="radio"/> On <input checked="" type="radio"/> Off
Frame rate*	30fps* ▼
Pre alarm (recording) duration	Off ▼
Post alarm (recording) duration	30s ▼

### Audio recording

Select whether or not to record audio data with **On** or **Off**. **On**: Audio data is saved in the video (MP4 format). **Off**: Audio data is not saved in videos (MP4 format).

#### NOTE!

If the audio distribution mode is set to bi-directional (half duplex), the settings cannot be made.

### Frame Rate

Set the frame rate of H.265 (or H.264) to be recorded.

#### NOTE!

Refer to the **Frame rate\*** below for the frame rate you can set and the bit rate that depends on the frame rate.

→[Configuring periodic SD recordings, p. 142](#)

### Pre alarm (recording) duration

Select whether to record before alarm. Sets the time to save to the SD card.

**Off/ 1s/ 2s/ 3s/ 4s/ 5s/ 8s/ 10s/ 15s/ 20s/ 25s/ 30s/ 40s/ 50s/ 60s/ 90s/ 120s**

#### NOTE!

The values that can be set depend on the resolution and bit rate of the stream to be recorded. The higher the bit rate, the smaller the maximum value that can be set as the pre-alarm time.

### Post alarm (recording) duration

Sets the time to save to the SD card after an alarm is generated.

**10s/ 20s/ 30s/ 40s/ 50s/ 60s/ 120s/ 180s/ 240s/ 300s**Next buttons

#### Next button

In the **Alarm Settings** window, do the following:

- Select **Alarm output** and press **Next** to configure the **Alarm Outputs**.  
→[Configuring alarm outputs, p. 138](#)
- Do not select **Alarm output** and press **Next** to configure the **Mail Settings**.  
→[Configuring email notification, p. 139](#)

#### Back button

Click on **Back** to return to the previous page.

## Configuring alarm outputs

The alarm output is set here. This message is displayed when **Alarm output** is selected in the alarm setting window.

To set the output terminal:

The screenshot shows a configuration window with two tabs: 'Internet' and 'Event action'. The 'Event action' tab is active. Below the tabs, there is a text instruction: 'Set the action of the output terminal when an alarm is detected. When "Latch" is selected for "Alarm output type", the alarm output is cancelled by clicking the alarm occurrence indication button in the "Live" page.' Below this instruction is a table with six rows of settings. At the bottom of the window are two buttons: 'Back' and 'Next'.

Output terminal	
Terminal output upon alarm detection	<input type="radio"/> On <input checked="" type="radio"/> Off
SD memory card error	<input type="radio"/> On <input checked="" type="radio"/> Off
Terminal state upon alarm detection	<input checked="" type="radio"/> Latch <input type="radio"/> Pulse
Terminal action upon alarm detection	<input type="radio"/> Open <input checked="" type="radio"/> Close
Pulse output width	<input type="text" value="1"/> s (1-120s)

For details of the settings on the screen above, refer to the following.

→[Configuring output terminal alarms, p. 262](#)

#### Next buttons

Click the **Next** button to display the mail setting screen.

→[Configuring email notification, p. 139](#)

#### Next button

Click on **Next** to proceed.

### **Back button**

Click on **Back** to return to the previous page.

### **Configuring email notification**

Here, the settings for mail are made.

## Detailed settings

### Using Easy Setup

Internet		Event action	
Set the method of mail notification when an alarm is detected.			
E-mail notification			
E-mail notification	<input type="radio"/> On	<input checked="" type="radio"/> Off	
Alarm image attachment	<input type="radio"/> On	<input checked="" type="radio"/> Off	
Image capture size	JPEG(2) (640x360)		
SMTP server address	Example of entry: 192.168.0.10		
SMTP port	25 (1-65535)		
POP server address	Example of entry: 192.168.0.10		
Authentication	Type	<input checked="" type="radio"/> None <input type="radio"/> POP before SMTP <input type="radio"/> SMTP	
	User name		
	Password		
Sender's E-mail address			
SSL	<input type="radio"/> On	<input checked="" type="radio"/> Off	
Destination of notification		Destination E-mail address	
Address 1			
	<input type="checkbox"/> Terminal 1 <input type="checkbox"/> Terminal 2 <input type="checkbox"/> Terminal 3 <input type="checkbox"/> VMD <input type="checkbox"/> SCD <input type="checkbox"/> Audio detection <input type="checkbox"/> Diag. <input type="checkbox"/> Auto track		
* For alarms by the "Ext. Software", e-mail notification will be provided only by configuring the destination e-mail address setting.			
E-mail subject(Alarm)		<input type="checkbox"/> Use the camera title <input type="checkbox"/> Cause of alarm	
E-mail subject(Diag.)		<input type="checkbox"/> Use the camera title	
E-mail body(Alarm)		<input checked="" type="checkbox"/> Cause of alarm <input checked="" type="checkbox"/> Occurrence time	
The %% alarm was occurred at %!%.			
<b>Back</b>		<b>Set</b>	

For details on how to set up the above screen, refer to the following.

→[Configuring SMTP \(E-mail\)](#), p. 315

### Set button

Click on **Set** to save your settings and to complete the configuration.

### Back button

Returns to the previous screen.

## Scheduling FTP transfers/SD recordings

On the **Schedule type** settings page, set **Trigger** to *SD memory recording* or *FTP/SFTP periodic image transmission*.

Trigger	SD memory recording ▼
Recording format	Stream(1) ▼ (H.265/1920x1080)

**Back** **Next**

### Trigger

- **FTP/SFTP periodic image transmission:** The JPEG image is sent to the FTP/SFTP server at the scheduled time.
- **SD memory recording:** Record H.265 (or H.264) images on the SD card at the scheduled time.

### Recording format

When **SD memory recording** is selected in **Trigger**, select the streams to be recorded.

### Next button

- Select **SD memory recording** and press **Next** to open the **Movie Record Setting** window.  
→[Configuring periodic SD recordings](#), p. 142
- Select **FTP/SFTP periodic image transmission** and press **Next** to open the **FTP/SFTP Periodic Transmission Settings** window.  
→[Configuring periodic FTP/SFTP recordings](#), p. 145

#### NOTE!

- **FTP/SFTP periodic image transmission** can be selected only for models with FTP/SFTP features.
- **FTP/SFTP Transfer** and **FTP/SFTP periodic image transmission** can both be set (when both actions take place at the same time, **FTP/SFTP Transfer** takes precedence).
- Selecting **SD memory recording** cancels the **FTP/SFTP periodic image transmission** setting.

## Configuring periodic SD recordings

Open the **Movie recording** page to configure this type of scheduled recording.

When the **Next** button is clicked after recording or setting the frame rate on the video recording setting screen, the schedule setting screen is displayed and you can set the schedule.

The recording, frame rate, and SD card are overwritten on the video recording setting screen.

Internet | **Event action**

Configure the recording condition of the SD memory recording when an alarm is detected.  
Even if "Audio detection alarm" is set to "On", recording to the SD memory card will not be performed when the alarm occurs.

Stream recording(Alarm)	
Audio recording	<input type="radio"/> On <input checked="" type="radio"/> Off
Frame rate*	30fps * ▾
Pre alarm (recording) duration	Off ▾
Post alarm (recording) duration	30s ▾

**Back** **Next**

### Audio recording

You set whether to record audio data.

**On:** Audio data is saved in the video (MP4 format).

**Off:** Audio data is not saved in videos (MP4 format).

**NOTE!**

- If the audio distribution mode is set to bi-directional (half duplex), the settings cannot be made.
- When **Overwrite** is switched from **Off** to **On**, the old images may be deleted to prepare for writing if there is not enough space on the SD card.

**Frame rate**

Set the frame rate of H.265 (or H.264) to be recorded from the following.

- If **Image capture mode** is set to 30 fps:  
1fps/ 3fps/ 5fps\*/ 7.5fps\*/ 10fps\*/ 12fps\*/ 15fps\*/ 20fps\*/ 30fps\*
- If **Image capture mode** is set to 25fps:  
1fps/ 3.1fps/ 4.2fps\*/ 6.25fps\*/ 8.3fps\*/ 12.5fps\*/ 20fps\*/ 25fps\*
- If **Image capture mode** is set to 15 fps:  
1fps/ 3fps/ 5fps\*/ 7.5fps\*/ 10fps\*/ 12fps\*/ 15fps\*
- If **Image capture mode** is set to 12.5 fps:  
1fps/ 3.1fps/ 4.2fps\*/ 6.25fps\*/ 8.3fps\*/ 12.5fps\*

**NOTE!**

When **Next** is clicked, **Transmission priority** is set to **Frame rate**.

The bit rate is automatically set according to the selected resolution and frame rate. Check the **Bit Rate\* per Client** settings for each stream.

**Overwrite**

You set whether to overwrite and save images when the free space on the SD card is running low.

**On:** If the free space on the SD card decreases, the old image is overwritten and saved repeatedly.

**Off:** If the SD card has no free space, the SD card stops storing data.

**NOTE!** When **Overwrite** is switched from **Off** to **On**, the old images may be deleted to prepare for writing if there is not enough space on the SD card.

**Next button**

Clicking **Next** displays the window for setting the recording schedule to the SD card.

**Back button**

Returns to the previous screen.

### Configure the schedule

Select "Recording to SD (Recording stream)" for "Schedule mode" of the schedule (1 - 8) to be registered, and set the recording schedule.  
When "Recording to SD (Recording stream)" is not select for "Schedule mode", recording will not be performed.

Schedules

Schedule 1 (White) <input type="checkbox"/>	Schedule mode	Off
	Time range	<input type="checkbox"/> Mon <input type="checkbox"/> Tue <input type="checkbox"/> Wed <input type="checkbox"/> Thu <input type="checkbox"/> Fri <input type="checkbox"/> Sat <input type="checkbox"/> Sun <input type="checkbox"/> 24h <input type="text"/> : <input type="text"/> - <input type="text"/> : <input type="text"/>
Schedule 2 (Blue) <input checked="" type="checkbox"/>	Schedule mode	Off
	Time range	<input type="checkbox"/> Mon <input type="checkbox"/> Tue <input type="checkbox"/> Wed <input type="checkbox"/> Thu <input type="checkbox"/> Fri <input type="checkbox"/> Sat <input type="checkbox"/> Sun <input type="checkbox"/> 24h <input type="text"/> : <input type="text"/> - <input type="text"/> : <input type="text"/>
Schedule 3 (Green) <input type="checkbox"/>	Schedule mode	Off

0:00 6:00 12:00 18:00 24:00

Mon

Tue

Wed

Thu

The color of each schedule is not linked with the area color of "VMD area".  
When "VMD permission" is set, the VMD functions in all the areas set with "VMD area".  
"VMD permission", "SCD permission" and "Auto track permission" are required to be set to specify a period of time where detection or tracking is to be performed. They are not required to be set when detection or tracking is to be performed regularly.  
"Auto mode (auto track)" and "Auto track from the right-click menu" on the "Live" page are available even when it is out of the period specified in "Auto track permission".  
If the camera direction is changed by other operation while the setting of preset position, auto pan, preset sequence or patrol is being performed, the camera will automatically move back to the previous preset position and resume the operation in 1 minute.

Back Set

For details on how to set up the above screen, refer to the following.

→[Using schedules, p. 345](#)

#### Set button

Click on **Set** to save your settings and to complete the configuration.

#### Back button

Click on **Back** to return to the previous page.

---



**NOTE!**

If **SD memory recording** is not selected in **Operation mode**, no recording is performed.

## Configuring periodic FTP/SFTP recordings

Open the **FTP/SFTP Periodic Transmission** page to configure this type of scheduled recording.

When **Next** is clicked after periodic transmission and setting of servers on the periodic transmission setting screen, the periodic transmission schedule setting screen is displayed and the schedule for periodic transmission can be set.

Settings for periodic transmission are made on the Periodic Transmission Setting screen.

Configure the FTP/SFTP server information and the method of JPEG image transmission to the FTP/SFTP server.

Transmission protocol	<input type="radio"/> FTP <input checked="" type="radio"/> SFTP
Periodic transmission settings	
Periodic image transmission	<input type="radio"/> On <input checked="" type="radio"/> Off
Directory name	<input type="text"/>
File name	<input type="text"/> <input checked="" type="radio"/> Name w/time&date <input type="radio"/> Name w/o time&date
Transmission interval	1s <input type="text"/>
Image capture size	JPEG(2) <input type="text"/> (640x360)
SFTP server setting	
SFTP server address	<input type="text"/> Example of enter: 100.169.0.10

Back Set

For details of the settings on the screen above, refer to the following.

→[Configuring FTP/SFTP transmission function, p. 319](#)

### Set button

Displayed when **FTP periodic image transmission** is **Off**. Clicking **Set** saves the settings.

### Next button

Displayed when **FTP periodic image transmission** is **On**. Clicking **Next** displays the window for setting FTP/SFTP scheduled periodic transmissions.

## Detailed settings

### Using Easy Setup

---

#### Back button

Click on **Back** to return to the previous page.

#### Configure the schedule

The screenshot shows the 'Event action' configuration screen. At the top, there are two tabs: 'Internet' and 'Event action'. Below the tabs, there is a text box with instructions: 'Select "Recording to SD (Recording stream)" for "Schedule mode" of the schedule (1 - 8) to be registered, and set the recording schedule. When "Recording to SD (Recording stream)" is not select for "Schedule mode", recording will not be performed.'

Below the text box is a table with three rows, each representing a schedule:

Schedule	Schedule mode	Time range
Schedule 1 (White) <input type="checkbox"/>	Off	<input type="checkbox"/> Mon <input type="checkbox"/> Tue <input type="checkbox"/> Wed <input type="checkbox"/> Thu <input type="checkbox"/> Fri <input type="checkbox"/> Sat <input type="checkbox"/> Sun <input type="checkbox"/> 24h [00:00] - [00:00]
Schedule 2 (Blue) <input checked="" type="checkbox"/>	Off	<input type="checkbox"/> Mon <input type="checkbox"/> Tue <input type="checkbox"/> Wed <input type="checkbox"/> Thu <input type="checkbox"/> Fri <input type="checkbox"/> Sat <input type="checkbox"/> Sun <input type="checkbox"/> 24h [00:00] - [00:00]
Schedule 3 <input type="checkbox"/>	Off	

Below the table is a calendar grid showing the time range for each day of the week. The time range is 0:00 to 24:00. The days are Mon, Tue, Wed, and Thu. The calendar shows a repeating pattern of a sawtooth shape, indicating a 24-hour cycle.

At the bottom of the screen, there are two buttons: 'Back' and 'Set'.

The color of each schedule is not linked with the area color of "VMD area".  
When "VMD permission" is set, the VMD functions in all the areas set with "VMD area".  
"VMD permission", "SCD permission" and "Auto track permission" are required to be set to specify a period of time where detection or tracking is to be performed. They are not required to be set when detection or tracking is to be performed regularly.  
"Auto mode (auto track)" and "Auto track from the right-click menu" on the "Live" page are available even when it is out of the period specified in "Auto track permission".  
If the camera direction is changed by other operation while the setting of preset position, auto pan, preset sequence or patrol is being performed, the camera will automatically move back to the previous preset position and resume the operation in 1 minute.

For details on how to set up the above screen, refer to the following.

→[Using schedules, p. 345](#)

#### Set button

Click on **Set** to save your settings and to complete the configuration.

### Back button

Click on **Back** to return to the previous page.

#### NOTE!

If **FTP/SFTP periodic image transmission** is not selected in **Operation mode**, no FTP/SFTP periodic transmission is performed.

## Basic setup of the camera

Basic pages set the camera title, date and time, SD card, and overlay. The basic pages consist of the **Basic**, **SD card**, and **Overlay image** tabs.

### Basic settings

On the Basic Page, press the **Basic** tab. Refer to the following how to display and operate the **Detailed settings** menu.

→[Accessing the camera settings menu, p. 109](#)

→[Editing the camera settings, p. 111](#)

The camera title, date, and time are set here.

#### Menu language

Select the first language that appears when you access the camera from the list below. **Auto/English/Japanese/Italian/French/German/Spanish/Chinese/Russian/ Portuguese**

**Auto:** The language used by the browser is automatically selected. If the machine does not support the language, the English language is selected.

#### Camera title

Enter the name of the camera. After input, press **Set** to display the entered name in the camera title.

- Number of characters that can be entered: 0 to 20 characters
- Characters that cannot be entered: Half-pitch symbol " &

#### Date/time

Enter the current date and time. If you selected **12h** in **Time display format**, select **AM** or **PM**.

When **Set PC time to the camera** is checked and **Set** is clicked, the date and time of the computer are obtained and set to the camera.

## Detailed settings

### Basic setup of the camera

---

Range: Jan/01/2013 00:00:00~Dec/31/2035 23:59:59

#### NOTE!

If you need to set the time more accurately in system operation, use the NTP server.

→[Configuring NTP, p. 327](#)

### Date/time display

Use **On** or **Off** to set whether the date and time are displayed on the images. When the date and time are not displayed, set it to **Off**.

#### NOTE!

<Multisensor>: **Date/time display** can be set individually by the cameras.

### Time display format

Select the time display method from 24h/12h. Enter the **Date/time** according to this setting. **Date/-time display format**

Select the date display format. If **Date/time** is set to **13:10:00 on April 1, 2022**, the display formats are as follows.

- DD/MM/YYYY: 01/04/2022 13:10:00
- MM/DD/YYYY: 04/01/2022 13:10:00
- DD/Mmm/YYYY: 01/Apr/2022 13:10:00
- YYYY/MM/DD: 2022/04/01 13:10:00
- Mmm/DD/YYYY: Apr/01/2022 13:10:00

### Date/time position

Select the position where the date and time are displayed on the image.

- **Upper left:** Displayed in the upper left corner of the window.
- **Lower left:** Displayed in the lower left corner of the window.
- **Upper center:** Displayed in the center of the window.
- **Lower center:** Displayed at the bottom center of the window.
- **Upper right** is displayed in the upper right corner of the window.
- **Lower right:** Displayed in the lower right corner of the window.

#### NOTE!

<Multisensor>: **Date/time position** can be set individually by the cameras.

### NTP

Clicking **NTP >>** displays the **Advanced** tabs for the network pages.

→[Configuring NTP, p. 327](#)

### Time zone

Select the time zone for the camera area.

### Summer time(daylight saving)

Use **In**, **Out** and **Auto** to specify whether to use Daylight Saving Time. Set in the region where Daylight Saving Time is used.

- **In**: Set the time to Daylight Saving Time. \* is displayed in the time display.
- **Out**: Reset Daylight Saving Time.
- **Auto**: Switches to Daylight Saving Time according to the start date and time and end date settings (month, week, day of week, time).

### Start time & date/End time & date

When **Auto** is selected in **Summer time(daylight saving)**, the start date and time of Daylight Saving Time and the end date and time of Daylight Saving Time are set in Month, Week, Day of Week, and Time.

### Display on screen

To make individual settings, select the camera and set the settings. Select the camera to set the following items individually for each camera.

- Date/time display
- Date/time position
- Camera title on screen display
- Camera title position

#### NOTE!

- <Multisensor>: When the image capture mode is Quad mode, Camera 1 is automatically selected and other cameras cannot be selected.
- <Multisensor>: Select Camera 1 in **Display on screen** and select **Reflect all settings for Camera 1** to set the settings you changed for Camera 1 to all other cameras.

### Camera title on screen display

Use **On/Off** to set whether the strings are displayed on the images.

When set to **On**, the character strings entered in **Camera title on screen** are displayed at the position selected in **Position**.

## Detailed settings

### Basic setup of the camera

---

#### NOTE!

<Multisensor>: **Camera title on screen display** can be set individually by the cameras.

#### Camera title on screen

Enter a character string to be displayed in the image. Number of characters that can be entered: 0 to 40 characters

Input Characters: One-byte (0-9, A-Z, a-z), two-byte (kanji, hiragana, katakana, alphanumeric), one-byte and two-byte symbols! " # \$ % & ' ( ) \* +, -. /; ; =?

#### NOTE!

- Up to two lines of **Camera title on screen** can be set.
- <Multisensor>: **Camera title on screen** can be set individually by the cameras.

#### Camera title position

Select the position where the character string is displayed in the image. **Upper left**: Displays in the upper left corner of the screen.

- **Lower left**: Displays in the lower left corner of the screen.
- **Upper center**: Displayed in the center of the screen. **Lower center**: Displays at the bottom center of the screen.
- **Upper right**: Displayed in the upper right corner of the screen.
- **Lower right**: Displays in the lower right corner of the screen.

#### NOTE!

<Multisensor>: **Camera title position** can be set by cameras.

#### Date and time&In-Screen Characters > Display type

Sets the display format to either **Permeation** or **Opaque**.

- **Permeation**: Displays the date and time and characters on the screen in transparent characters.
- **Opaque**: Displays date and time and on-screen characters in opaque (black-coated) characters.

#### Date and time&In-Screen Characters > Character size

Select the date and time displayed in the image and the character size of the character string (percentage of default size 100%).

**NOTE!**

- If the **Date/time position** and **Camera title position** settings are different, the frame rate may be lower than the set value.
- If the **Date/time position** and **Camera title position** settings are different, the characters may run out or overlap depending on the **Character size** setting and the number of characters. Confirm the display results before use.
- If **Character size** is set to **150%** or **200%**, the frame rate may be lower than the set value.
- Depending on the **Character size** setting and the number of characters or the resolution of the images, it may be displayed only halfway or difficult to read. Confirm the display results before use.
- Even if 50% and 75% are set, the images of 640 x 360, VGA, 320 x 180, and QVGA show 100% **Camera title on screen**.
- If **Detailed settingOverlay** is set to **On**, the date and time&Characters on the Screen: You cannot set **150%** or **200%** in **Character size**.

**Brightness status display**

ON/OFF is used to set whether the brightness status is displayed when adjusting the brightness.

**NOTE!**

The brightness display in the image is displayed when the brightness is adjusted on the system device.

**Stabilizer**

ON/OFF is used to specify whether or not the camera's shaking correction function is enabled. The gyroscope sensor can be used to compensate for low-frequency vibrations such as pole vibrations caused by wind and fine vibrations at high magnification, thereby shooting images with less blurring.

- Use this function only when the camera is installed in an environment in which the camera frequently swings. It is effective to reduce the vibration.
- Check the operation during installation.
- Do not use the shaking correction function when using the product in an environment where there is no shaking.

## Detailed settings

### Basic setup of the camera

---

#### CAUTION!

- When set to **On**, the field angle is narrowed. Check the field angle when mounting the camera.
- Picture correction does not work in the following cases.
  - Pan and tilt zoom are executing.
  - During position refresh
- In the following cases, it may not be possible to obtain sufficient shaking compensation depending on the shooting conditions.
  - When the subject is dark
  - Rapid oscillation, such as mechanical vibration
  - Large-amplitude shaking
  - Image quality/position setting in progress
- If the **Stabilizer** setting is changed with the following area set, the set area will be misaligned. Set **Stabilizer** and then set the respective areas.
  - Mask area
  - Privacy Zone
  - Operation detection area
  - VIQS area

#### NOTE!

- When shaking occurs in a dark shooting environment, the shaking correction effect may be improved by setting the maximum exposure time to **1/100s** or faster shutter setting. Set the maximum exposure time depending on the installation environment.
- When **Stabilizer** is set to **On**, the superdynamic setting is **Off**.
- When **Stabilizer** is set to **On**, the digital zoom factor is limited to half.

#### Image Rotation

Available options: 0° (Off), 90°, 180° (Upside-down), 270°.



#### NOTE!

- If the **Image rotation** setting is changed with the following areas already defined, the areas will be misaligned. Set **Image rotation** first, then set the respective areas.
  - Privacy Zone
  - Operation detection area
  - Undesired detection area
  - VIQS area
  - Mask area
  - Overlay image
- If **Image rotation** is set to **90°** or **270°**, the on-screen characters may be broken depending on the **Character size** setting and the number of characters.
- When **Image rotation** is set to **90°** and **270°**, the positions that can be set to **Date/time position** and **Camera title position** are limited to **Upper left** and **Lower left**.
- Depending on the **Image capture mode**, you may not be able to set **Image Rotation** to **90°** or **270°**.

#### Mirror

Use **On/Off** to set whether the images are reversed left or right.

**NOTE!** If **Image rotation** is set to **90°** or **270°**, mirror inversion cannot be activated.

#### Indicator

Select the ON/OFF status of the lamp. To check the operation status with the lamps, select **On**.

When shaking occurs in a dark shooting environment, the shaking correction effect may be improved by setting the maximum exposure time to **1/100s** or faster shutter setting. Set the maximum exposure time depending on the installation environment.

- When **Stabilizer** is set to **On**, the superdynamic setting is **Off**.
- When **Stabilizer** is set to **On**, the digital zoom factor is limited to half.
- <PTZ>: **Indicator** can be set from the PTZ camera.

#### Audio out

Sets whether to use the audio output terminal as the adjustment monitor output.

## Detailed settings

### Basic setup of the camera

---

#### NOTE!

- When **Audio out** is set to **Audio**, **Monitor out** cannot be selected.
- If you set **Audio transmission mode** to other than **Off** or **Mic input**, you cannot set **Audio out** to **Monitor**.
- If you set **Audio out** to **Monitor**, you cannot set **Audio transmission mode** to anything other than **Off** or **Mic input**.

#### Monitor out

Set the image format to be output from the image output terminal (MONITOR OUT).

#### NOTE!

- **Monitor out** can be changed when the imaging mode is 30 fps, 60 fps, or 15 fps.
- The output image may be reversed up or down.

#### Tilt adjustment lever position

Set the **Tilt adjustment lever position** set when the camera is installed (**High/Mid Low**).

#### NOTE!

<PTZ>: The **Tilt adjustment lever position** can only be selected for the Multisensor camera settings.

## SD card options

On the Basic Page, press the **SD card** tab. Refer to the following how to display and operate the **Detailed settings** menu.

→[Accessing the camera settings menu, p. 109](#)

→[Editing the camera settings, p. 111](#)

Here, settings for the SD card are made.

## Operation mode

### SD Card

You set whether to use the SD card or not.

#### NOTE!

If **Image capture mode** is set to **16:9 Mode (60fps Mode)** or **16:9 mode(50fps mode)**, the SD card functions are not available. **SD card** is set to **Not use**.

### Ext. software mode

This setting is set to **On** when the installed function extension software uses the SD card of the camera.

- **On:** The function extension software can use the SD card of the camera.
- **Off:** The function extension software cannot use the SD card of the camera.

#### NOTE!

- It is recommended to format the SD card when setting the function extension software mode from **On** to **Off**.
- The operation of the recording function to the SD card cannot be guaranteed when the extended software using the SD card is operated.

### SD memory card file system type

You can select the file system format of the SD memory card. This can be selected only when **Ext. software mode** is **On**.

- **FAT(FAT16/FAT32/exFAT):** FAT formatted SD memory cards can be used.
- **ext(ext4):** ext formatted SD memory cards can be used.

#### NOTE!

- If you change **SD Memory Card File System Format**, click the **Execute** button in **Format** to format the SD memory card.
- When “ext(ext4)” is selected, the SD memory card can be used only with function extension software. Therefore, you will not be able to use functions such as recording video and audio to the SD memory card, or notification of remaining space in the SD memory card.
- When "ext(ext4)" is selected, the past information on the SD memory card will be deleted and cannot be displayed in the **Status** tab of the Maintenance page.
  - [Checking the camera status, p. 354](#)
- When “ext(ext4)” is selected, the capacity of the SD memory card cannot be displayed.
  - [SD card options, p. 154](#)
  - [Display the log list, p. 81](#)
  - [Viewing images from tablet computers, p. 66](#)

### Audio recording

You can set whether to record audio data when storing videos in MP4 format.

## Detailed settings

### Basic setup of the camera

---

- **Off:** Audio data is not saved in videos (MP4 format).
- **On:** Audio data is saved in the video (MP4 format).

#### **NOTE!**

If you use **Audio recording**, you must set **Recording format** to streams.

### Remaining capacity notification

To notify the remaining capacity of the SD card using the mail notification function or the unique alarm notification function, select the following whether to start notification when the free space reaches the selected percentage.

#### **NOTE!**

Remaining capacity notification is made for each remaining capacity value below the set value. For example, when set to **50%**, the remaining capacity is 50%, 20%, 10%, 5%, and 2%, respectively. The timing of notification may deviate slightly.

### Overwrite

You set whether to overwrite and save images when the free space on the SD card is running low.

- **On:** If the free space on the SD card decreases, the old image is overwritten and saved repeatedly.
- **Off:** If the SD card has no free space, the SD card stops storing data.

#### NOTE!

- If you do not want to use the SD card, set it to **Not use**.
- Before removing the SD card from the camera, be sure to set it to **Not use**. If the SD card is set to **Use**, the SD card may be damaged.
- When the SD card is set to **Use**, the SD card is saved according to the **Save trigger** setting.
- After installing the SD card, set it to **Use**.
- If the image update speed is high, the timing and interval of notification and recording may be misaligned. In addition, when multiple users receive images, notification or recording may not be performed as set. In that case, slow down the image update rate.
- The number of SD card rewrites is limited. If rewriting is frequent, the life of the SD card may be shortened.
- The life of the SD card is affected by the number of image files saved to the SD card and the number of logs written.
- You can reduce the number of files saved to the SD card by selecting the stream in **Recording format** and setting the smaller value in **Bit Rate/Client** of the stream to be recorded.
- If the SD card is written more frequently and the writing speed decreases, it is recommended to replace the new SD card.
- When switching from **Off** to **On**, when the free space on the SD card is small, old images may be deleted to prepare for writing.

## SD Card security setting

### Additional info for detecting alteration

Set whether to add information to enable detection when data on the SD card is falsified. Falsification detection supports only video (MP4 format) and can be checked using dedicated software.

In **Advanced Settings**, click the **button** to display the setting window for adding falsification detection information in a separate window.

→[Detecting tampering, p. 165](#)

### SD card password lock

Set the password on the SD card. When you set the password, you cannot write to or read from the SD card on any device other than this unit. If the SD card is stolen or lost, the risk of leakage of the recorded data can be reduced.

### Set

If an SD card with no password set is inserted, the password can be set using the Set button.

## Detailed settings

### Basic setup of the camera

---

#### Password/Retype password

Type a password.

- Number of characters that can be entered: 4 to 16 characters
- Characters that cannot be entered: Double-byte and single-byte symbols " &

#### Reset

If an SD card with the password set has been inserted, the password can be canceled by pressing the release button.

#### Password

Type a password.

- Number of characters that can be entered: 4 to 16 characters
- Characters that cannot be entered: Double-byte and single-byte symbols " &

#### Change

If an SD card with the password already set is inserted, the password can be changed by using the Change button.

#### Old password/New password/Retype new password

Type a password.

- Number of characters that can be entered: 4 to 16 characters
- Characters that cannot be entered: Double-byte and single-byte symbols " &

#### Status

Displays the password lock setting status.

- **During locking:** The SD card has a password and the lock function is enabled.
- **Not set:** Lock function is disabled
- The password setting status of the SD card is displayed.
- **Password already set:** The password is set correctly.
- **Error (unsupported SD card):** Password lock not supported card is inserted. Check that the SDHC Memory Card or SDXC Memory Card is inserted.
- **Error (password mismatch):** The SD card cannot be used because the password set on the SD card and the password set on this camera do not match. Confirm the password is correct.
- **Errors (other errors):** This message is displayed when an error occurs in the SD card. Check the SD card.

**NOTE!**

The password lock function supports SDHC memory card or SDXC memory card only.

When using an SD card with Password lock set on a device other than this device, release the password by pressing the Password lock release button, and then remove the SD card from the card.

You cannot cancel the password on any device other than the camera, such as a PC.

If the **SD card password lockStatus** is **Lock** and the SD card with no password setting is inserted into the camera, the password is automatically set to the SD card.

**CAUTION!**

- If you forget the set password, you cannot cancel the password. Since the SD card with the password set cannot be used, be sure to manage it carefully.
- If you forget the set password and want to replace it with a new SD card, set the **SD card password lockStatus** to **Not been set** in advance by following one of the steps below.
  - Enter the password using the release button and press the set button.
  - Initialize the set value from the maintenance page.

## Recording streams

### Recording format

Select the type of image data to be saved on the SD card.

- **Off:** Image data is not saved.
- **JPEG(*n*):** Still image (JPEG(*n*)) is saved according to the resolution set in the **Image** tabs of the video and audio pages.
- **Stream(*n*):** Save the video (stream (*n*)) in MP4 format according to the settings for this stream on the **Image** tabs of the video and audio pages.

#### NOTE!

- Use an UHS-I (Ultra High Speed-I)-compatible card for the Speed Class 10 SD card.
- When using SD cards other than those compatible with Speed Class 10, the bit rate of streams selected with **Recording format** should be 6144 kbps.
- When using SD cards compatible with Speed Class 10, the bit rate of streams selected by **Recording format** should be up to 12288 kbps.
- <Multisensor>: The SD card cannot be used except for the Speed Class 10.
- <Multisensor>: The bit rate of the streams selected in **Recording format** should be up to 4096 kbps.
- When **Stream** is selected, the **Stream** settings in the **Image** tabs of the video and audio pages are **Streams**.&This switches to the **Record video** setting.
- When **Recording format** is changed to **Stream**, the following functions may be corrected.
  - **Transmission priority** is set to **Best effort**, it is set to **Frame rate**.
  - If **Refresh interval** is set to **2s**, **3s**, **4s**, or **5s**, then it is set to **1s**.
- **Recording format** cannot be changed to **JPEG** if **On** is set to **Additional info for detecting alteration**.
- If **Recording format** is **Stream**, the file to be saved is named automatically.
- If **Recording format** is **Stream**, there may be fewer users that can be connected.
- If you configure **On** for **Audio recording**, the maximum bit rate that can be configured for streams is limited.
- If you configure **On** for **Additional info for detecting alteration**, the maximum bit rate that can be configured for streams is limited.
- <Multisensor>: If **Stream** is selected in **Recording format**, the bit rate is restricted.

#### Save trigger

Select the method below to save images on the SD card.

- **FTP/SFTP periodic transmission error**: FTP/Save the image when periodic transmission to the SFTP server fails.
- This option is available only when **JPEG** is selected in **Recording format**. **Alarm input**: Saves the image when an alarm is generated.
- **Manual**: Save the image manually.
- **Schedule**: Save the image according to the schedule settings. This option is available only when **Stream** is selected in **Recording format**.
- →[Using schedules, p. 345](#)



- When **Alarm input** is selected in **Save trigger**, the alarm type can be selected from the following. Terminal 1: The image is saved when an alarm is generated at terminal 1.
- Terminal 2: Image is saved when alarm is generated at terminal 2. **Terminal 3**The image is saved when an alarm is generated at terminal 3. **VMD**: Image is saved when operation detection occurs.
- **SCD**: The image is saved when screen change detection occurs. **Auto track**: Save the image when auto tracking occurs.
- **Command alarm**: Saves the image when a command alarm is entered.

#### NOTE!

- If **Recording format** is streamed, **FTP/SFTP periodic image transmission error** cannot be set.
- To generate an alarm, use the **Alarm** tabs to set the alarm.
- If **Recording format** is **JPEG**, **Schedule** cannot be set.
- When connected to our network disk recorder, **Save trigger** may be grayed out by **Network failure**. To change the **Save trigger** setting after you disconnect the recorder, set **SD card** to **Not use** and then set **Use** again.
- If **GOP control** is set to Advanced (Fixed GOP 60s + 1s keyframe), alarm recording cannot be set.
- Images are not recorded when sound detection alarm is generated.

## Manual JPEG recording

JPEG recording(Manual)	
File name	img_
Image saving interval	1fps ▾

This setting is available only when **Recording format** is set to **JPEG(1)** or **JPEG(2)** and **Save trigger** is set to **Manual**.

### File name

Enter the file name for saving images to the SD card. The following file names are actually saved.

- File name: File name entered + Date and time (year, month, day, minute, second) + Sequence number

## Detailed settings

### Basic setup of the camera

---

- Number of characters that can be entered: 1 to 8 characters
- Characters that cannot be entered: Double-byte and single-byte symbols " & \* /; < >? ¥ |

### Image saving interval

If **Save trigger** is set to **Manual**, select the interval to save images to the SD card from the following.

- When **Image capture mode** is set to 30 fps/15 fps: 0.1 fps/0.2 fps/0.33 fps/0.5 fps/1 fps
- When **Image capture mode** is set to 25 fps/12.5 fps: 0.08 fps/0.17 fps/0.28 fps/0.42 fps/1 fps

## JPEG recording of alarms

JPEG recording(Alarm)		
File name	img_	
Image saving interval/Number of images to be saved(Pre alarm)	Image saving interval 1fps ▾	Number of images to be saved Off ▾
Image saving interval/Number of images to be saved(Post alarm)	Image saving interval 1fps ▾	Number of images to be saved 100 pics ▾

This setting is available only when **Recording format** is set to **JPEG(1)** or **JPEG(2)** and **Save trigger** is set to **Alarm input**.

### File name

Enter the file name for saving images to the SD card. The following file names are actually saved.

- File name: File name entered + Date and time (year, month, day, minute, second) + Sequence number
- Number of characters that can be entered: 1 to 8 characters
- Characters that cannot be entered: Double-byte and single-byte symbols " & \* /; < >? ¥ |

## Storage interval/number of images (pre-alarm)

### Image saving interval

When **Save trigger** is set to **Alarm input**, select the pre-alarm image interval to save the image to the SD card.

- When **Image capture mode** is set to 30 fps/15 fps: 0.1 fps/0.2 fps/0.33 fps/0.5 fps/1 fps
- When **Image capture mode** is set to 25 fps/12.5 fps: 0.08 fps/0.17 fps/0.28 fps/0.42 fps/1 fps

### Number of images to be saved

Select the number of pre-alarm images to be saved to the SD card when an alarm is generated.

## Storage interval/number of images (Post alarm)

### Image saving interval

If **Save trigger** is set to **Alarm input** or **Manual**, select the intervals below to save images to the SD card.

- When **Image capture mode** is set to 30 fps/15 fps: 0.1 fps/0.2 fps/0.33 fps/0.5 fps/1 fps
- When **Image capture mode** is set to 25 fps/12.5 fps: 0.08 fps/0.17 fps/0.28 fps/0.42 fps/1 fps

### Number of images to be saved

Select the number of alarm images to be saved to the SD card when an alarm is generated from the following list.

## Movie recording (when alarm is generated)

Stream recording(Alarm)	
Pre alarm (recording) duration	Off ▼
Post alarm (recording) duration	30s ▼

This setting is available only when the **Recording format** of the SD card is set to streaming and **Save trigger** is set to **Alarm input**.

### Pre alarm (recording) duration

Select whether to record before alarm. Sets the time to save to the SD card.

#### NOTE!

The values that can be set depend on the resolution and bit rate of the stream to be recorded. The higher the bit rate, the smaller the maximum value that can be set as the pre-alarm time.

### Post alarm (recording) duration

Sets the time to save to the SD card after an alarm is generated.

**NOTE!** The actual recording time may be longer than the time set for the post alarm time.

## SD card information

### Remaining capacity

The remaining capacity and total capacity of the SD card are displayed. Depending on the status of the SD card, it may be displayed as follows.

## Detailed settings

### Basic setup of the camera

---

Display	Description
-----MB/-----MB	<ul style="list-style-type: none"><li>SD card is not inserted.</li><li>Capacity cannot be listed due to a read error.</li></ul>
*****MB/*****MB	SD card is not formatted.
#####MB/#####MB	The password lock of the SD card cannot be removed.

---

#### NOTE!

When **Overwrite** is set to **Off** and the remaining capacity of the SD card becomes **0MB**, images are not saved to the SD card. When the free space on the SD card runs out, the specified mail address and unique alarm notification destination can be notified with the notification function.

→[Setting up email notification for alarms, p. 269](#)

→[Configuring alarm notifications, p. 287](#)

#### Format

Format in the file format selected in **SD Memory Card File System Format**.

→[SD card options, p. 154](#)

To format the SD card, press **Execute**.

#### NOTE!

- When formatting an SD memory card with **ext(ext4)** selected for **SD Memory Card File System Format**, formatting may take about 20 minutes until it is completed depending on the SD memory card.
- After formatting the SD memory card in ext format, check the operation of the extension software using the SD memory card.

### CAUTION!

- Prior to formatting, set **SD memory card** to **Use** on the basic pages.  
→[Operation mode, p. 154](#)
- The SD Memory Card must be formatted using the **SD memory card** tabs before using it. The following functions may not work properly when formatted outside of the **SD memory card** tabs.
  - Save/retrieve image when alarm is generated
  - Save/retrieve images when manually saved
  - Save/retrieve images using the Schedule function
  - Save/retrieve alarm log, manual/schedule save log, system log
  - Saving/retrieving images using SD Memory recording function of our network disk recorder
  - Play/download images on the SD Memory Card
- When formatting is performed, the operation is interrupted if another user is working on it.
- You cannot write to the SD Memory Card during formatting.
- When formatting is performed, all data stored on the SD Memory Card are deleted.
- Do not turn off the computer during formatting.
- After formatting, the SD Memory Card displays less than the total amount of space because it creates the initial directory required to operate.
- When recording images repeatedly on an SD Memory Card using the automatic overwrite function, use an SD Memory Card with high reliability and durability.
- Use an UHS-I (Ultra High Speed-I)-compatible card for the SD Memory Card that supports the speed class Class 10.

## Installing and removing the SD card

### Insert/Remove SD memory card mode

To install or remove an SD Memory Card, press **Execute**.

After the SD Memory Card has been installed and removed, click the **Release** button.

## Detecting tampering

When the data on the SD card is falsified, the data can be detected using the dedicated software.

Falsification detection supports only video files (MP4 format).

## Detailed settings

### Basic setup of the camera

#### NOTE!

If you use **Alteration detection**, you must set **Recording format** to streaming.

Alteration detection	
Select certificate	Pre-installed ▾
Additional info for detecting alteration	<input type="radio"/> On <input checked="" type="radio"/> Off
<b>Set</b>	
Pre-installed certificate	
Certificate download	<b>Execute</b>
CA Certificate	
CRT key generate	<b>Execute</b>
Generate Certificate Signing Request	<b>Execute</b>
CA Certificate install	ファイルを選択 選択されていません <b>Execute</b>
Information	Invalid <b>Confirm</b> <b>Delete</b>
Certificate download	<b>Execute</b>
<b>Close</b>	

#### Select certificate

Select the certificate to use for falsification detection.

- **Pre-install:** Select the pre-installation certificate.
- **CA:** Select a CA certificate. This is displayed only if the CA certificate is installed.

#### Additional info for detecting alteration

Set whether to add the information for detecting tampering to the video file (MP4 format) to be saved in the SD card.

#### NOTE!

If the **Recording format** of **Recording stream** is set to JPEG, the setting cannot be changed to **On**.

#### Pre-install Certificate-Get Certificate

Click the Run button to download the route certificate for the pre-installation certificate. Use the downloaded certificate to detect falsification of videos (MP4 file) on the SD card using the dedicated

software.

### **CA certificate-CRT key generation**

Creates a CRT key (encryption key) for use in falsification detection.

CRT key generation is performed in **CRT key generation dialog** displayed when **Execute** is clicked.

### **CA Certificate-Create Signature Request (CSR)**

When using CA certificates issued by a certification authority as CA certificates for use in tampering detection, it generates a signature request (CSR) to apply to the certification authority. Create a signature request (CSR) by clicking on the **Execute** button. This is displayed in the **Create Signature Request (CSR) dialog**.

### **CA certificate-certificate installation**

This feature installs certificates (CA certificates) issued by certification agencies and displays information about installed certificates (CA certificates).

When **Select File** is clicked, the **Open File Dialog** is displayed. Select the certificate (CA Certificate) file issued by the certification authority. Click **Execute** to install the certificate (CA Certificate).

If a certificate (CA certificate) is installed, the file name of the installed certificate is displayed.

### **CA certificate-information**

The information of the certificate (CA certificate) issued by the certification authority is displayed.

When **Execute** is clicked, the registered contents of the installed certificate (CA certificate) are displayed in **CA Certificate Confirmation Dialog**.

Clicking **Delete** deletes the installed certificate (CA certificate).

### **CA Certificate-Get Certificate**

The certificate (CA certificate) issued by the certification organization is downloaded from this machine.

Use the downloaded certificate to detect falsification of videos (MP4 file) on the SD card using the dedicated software.

**CAUTION!** When deleting a valid certificate (CA certificate), make sure that you have a backup of the certificate (CA certificate) on your PC or recording media. To reinstall, a certificate (CA certificate) is required.

## **Configuring overlay images**

The overlay image function embeds images uploaded to the camera into live images (overlay display).

## Detailed settings

### Basic setup of the camera

On the Basic Page, press the **Overlay image** tab. Refer to the following how to display and operate the **Detailed settings** menu.

→[Accessing the camera settings menu, p. 109](#)

→[Editing the camera settings, p. 111](#)

Here, the overlay image function is set.

Basic	SD memory card	Overlay image
		
Overlay image		
Overlay	<input type="radio"/> On <input checked="" type="radio"/> Off	
Image Selection	<input type="text" value="ファイルを選択 選択されていません"/> <input type="button" value="Execute"/>	
Position	X <input type="text"/>	Y <input type="text"/>
Permeation	<input type="radio"/> On <input checked="" type="radio"/> Off	
Selection of color to be penetrated	<input type="button" value="Color Selection"/> R:255,G:255,B:255 <input type="text"/>	
<small>* In case of upload of overlay image and drag of overlay image, the setting will be immediately reflected. *If "Character size" of "OSD" is "150%" or "200%", "Overlay image" is not selectable.</small>		
<input type="button" value="Set"/>		

### Overlay image

Select the camera for which you want to set the overlay.

**NOTE!** <Multisensor>: **Camera selection** can be selected only for Multisensor cameras.



## Overlay

Use **On** or **Off** to set whether the uploaded images are overlaid or not.

- **On:** Displays the overlay in live and recorded images.
- **Off:** Overlay is not displayed.

### NOTE!

If **Character size** is set to **150%** or **200%** for **Characters in Date/Time Screen**, **Overlay** cannot be set.

## Image Selection

Follow the procedure below to upload an overlay image file to the camera.

1. Click the **Select File** button to select the image file saved in the PC.
2. Click **Execute** to upload the selected image files to the camera. When an image file is uploaded, the uploaded image (uploaded image) is displayed as an overlay on the setting screen.

You can use image files with the following specifications for overlay display:

- Image format: 256 color bitmap (BMP: Windows format)
- Image size: 24 pixels x 24 pixels to 512 pixels x 512 pixels
- File capacity: 257 Kbytes or less

### NOTE!

Save the image file in a folder that does not use space or double-byte characters. You may not be able to upload files saved in spaces or folders using double-byte characters.

### CAUTION!

- Do not turn off the camera or operate the camera during upload of the image file.
- The uploaded image displayed is reduced depending on the resolution of the live image. The image quality of the uploaded image may deteriorate and be displayed. Check the image overlaid on the live image page.
- The uploaded image is saved when uploaded.

## Position

The uploaded image display position (upper left corner of the image) is displayed with **X** and **Y** coordinates.

## Detailed settings

### Basic setup of the camera

Basic SD memory card **Overlay image**



Overlay image		
Overlay	<input checked="" type="radio"/> On	<input type="radio"/> Off
Image Selection	<input type="button" value="Choose File"/> No file chosen	<input type="button" value="Execute"/>
Position	X <input type="text" value="274"/>	Y <input type="text" value="170"/>
Permeation	<input type="radio"/> On	<input checked="" type="radio"/> Off
Selection of color to be penetrated	<input type="button" value="Color Selection"/>	R:255,G:255,B:255 <input type="text"/>

\* In case of upload of overlay image and drag of overlay image, the setting will be immediately reflected.  
\*If "Character size" of "OSD" is "150%" or "200%", "Overlay image" is not selectable.

There are two ways to change the display position of uploaded images.

- Drag and drop the uploaded image with the mouse.
- Enter the coordinates for **X** and **Y** and press **Set**
  - If **Image capture mode** is **16:9 mode**:
    - X: 0 to 639, minus the size next to the uploaded image
    - Y: 0 to 359, minus the vertical size of the uploaded image
  - If **Image capture mode** is **4:3 mode**
    - X: 0 to 639, minus the size next to the uploaded image
    - Y: 0 to 479, minus the vertical size of the uploaded image

**NOTE!**

- You can change the display position by moving the red frame displayed when dragging the uploaded image.
- Coordinates for displaying uploaded images to protrude from the top of the setting screen cannot be set.
- When uploaded images are moved by the mouse, the display position is saved without clicking the **Set** button.
- Even if you move the uploaded image to the edge of the screen, there may be a gap between the image and the edge of the screen.

**CAUTION!** After changing the **Image capture mode** settings, check the position of the uploaded images. If the display position is misaligned, set the display position again. If the uploaded image is displayed out of the setting screen, the display position returns to the initial value (center of the live image).

**Permeation**

Use **On** or **Off** to set whether or not the selected colors are transmitted by **Selection of color to be penetrated**.

- **On:** Transmits colors selected in **Selection of color to be penetrated**.
- **Off:** The colors selected in Selection of color to be penetrated are not transmitted. Selection of color to be penetrated

## Detailed settings

### Configuring image and audio options for recordings

---

Select the color to be transmitted as shown below.

1. Clicking **Color Selection** displays the window with the uploaded images.



2. Click the color to be transmitted in the displayed image. The selected color and RGB values are displayed.
3. Click on **Close** to close the window.
4. Click on **Set** render the selected colors transparent.

## Configuring image and audio options for recordings

- Image/Audio pages configure JPEG images, H.265 images and H.264 images, and set image quality and sound.
- Video/Audio pages consist of the **Image**, **Image quality**, and **Audio** tabs.

### Setting image modes

Click the **Image** tabs on the video pages. Refer to the following how to display and operate the **Detailed settings** menu.

→[Accessing the camera settings menu, p. 109](#)

→[Editing the camera settings, p. 111](#)

#### Image capture mode

Select the image to be displayed on the live image, etc.

Camera type	Imaging mode
PTZ camera	16:9 (30 fps mode)
	16:9 (25fps mode)
	16:9 (60 fps mode)
	16:9 (50 fps mode)
	4:3 (15 fps mode)
	4:3 (12.5 fps mode)
	4:3 (30 fps mode)
	4:3 (25fps mode)
Multisensor camera	5 megapixels <b>16:9</b> (15 fps mode)
	5 megapixels <b>16:9</b> (12.5 fps mode)
	5 megapixels <b>16:9</b> (15 fps Quad mode)
	5 megapixels <b>16:9</b> (12.5 fps Quad mode)
	5 megapixels <b>4:3</b> (15 fps mode)
	5 megapixels <b>4:3</b> (12.5 fps mode)
	5 megapixels <b>4:3</b> (15 fps Quad mode)
	5 megapixels <b>4:3</b> (12.5 fps Quad mode)

---

#### CAUTION!

- If you change the image pickup mode setting with the following area setting, the position will be misaligned. Therefore, after setting the imaging mode, set each area.
  - Mask area  
→[Setting mask areas, p. 201](#)
  - Privacy Zone  
→[Setting the privacy zone \(Privacy zone setting screen\), p. 210](#)
  - Operation detection area  
→[Defining VMD areas for motion detection, p. 279](#)
  - Undesired detection area  
→[Defining SCD areas for screen change detection, p. 283](#) VIQS area  
→[Defining VIQS areas, p. 221](#)
  - Overlay image  
→[Configuring overlay images, p. 167](#)
- The **16:9 mode(60fps mode)/16:9 mode(50fps mode)/4:3 mode(15fps mode)/4:3 mode(12.5fps mode)** imaging modes do not allow the use of advanced features or autotracking features.
- <Multisensor>: If a slow shutter mode is set during operation, such as at night, it may take a lot of time to complete the setting.

#### NOTE!

- If the VIQS area is enabled, make sure that the VIQS settings do not exceed the maximum range after changing the aspect ratio from **4:3** to **16:9**.
- In 2 megapixels **16:9** (60 fps mode), when multiple streams are delivered, 60 fps delivery is not possible and the image may be displayed intermittently. If the voice is simultaneously delivered, the data will be delivered at 30 fps.

## Configuring JPEG image options

Click on the **Image** tabs of the video and audio pages. Refer to the following how to display and operate the **Detailed settings** menu.

→[Accessing the camera settings menu, p. 109](#)

→[Editing the camera settings, p. 111](#)

## Live image (initial display)

Here, the default setting to be displayed on the live picture is performed. **Initial display stream**  
Select the image to be displayed on the live image page from the following.

### PTZ camera

JPEG(1)/ JPEG(2)/ **Stream(1)/Stream(2)/Stream(3)/Stream(4)/Multisensor + PTZ**

### Multisensor camera

**4 image display stream (2), 3 image display stream (2), 4 image display JPEG**, [3 image display JPEG], **3 image display 1 stream (1), Camera 1 stream (2), Camera 1 JPEG**, [Camera 1 JPEG], **Camera 2 stream (1), Camera 2 stream (2), Camera 2 JPEG, Camera 3 stream (1), Camera 3 stream (2), Camera 3 JPEG, Camera 4 stream (1), Camera 4 stream (2), and Camera 4 JPEG/Camera 4 JPEG/Multisensor + PTZ**

#### NOTE!

- Selecting JPEG enables you to select the update interval.  
MJPEG/ **Refresh interval: 1s/Refresh interval: 3s/Refresh interval: 5s/Refresh interval: 10s/Refresh interval: 30s/Refresh interval: 60s**
- The streams can be selected when **Stream transmission** is **On**.
- <Multisensor>: When **4 image display JPEG/3 image display JPEG** is selected, **Refresh interval: 1sStill image update: 3 seconds** cannot be selected.
- <Multisensor>: Select **4 image display stream (2), 3 image display stream (2), 4 image display JPEG**, or **3 image display JPEG** to select the following display method.
- **4 split/360 deg.**
- <Multisensor>: Four-image display is available for the four-eye model.
- <Multisensor>: Three-image display is available for the three-eye model.

### JPEG image updating speed (movie)\*

Select the rate at which the JPEG image is updated.

**If Image capture mode is set to Single source [4:3(30fps mode)]/Dual sources [4:3(15fps mode)]/60fps mode:**

0.1fps/ 0.2fps/ 0.33fps/ 0.5fps/ 1fps/2fps/ 3fps/ 5fps/ 6fps/ 10fps/ 12fps/ 15fps/ 30fps

**If Image capture mode is set to Single source [4:3(25fps mode)]/Dual sources [4:3(12.5fps mode)]/50fps mode:**

0.08fps/ 0.17fps/ 0.28fps/ 0.42fps/ 1fps/ 2.1fps/ 3.1fps/ 4.2fps/ 5fps/ 8.3fps/ 12.5fps/ 25fps

## Detailed settings

### Configuring image and audio options for recordings

---

#### NOTE!

- If **Stream transmission** is set to **On** and the value with \* is set, the image updating rate may be lower than the set value. The value with \* depends on the model. Refer to this item on the detailed camera setting screen for the relevant parameters.
- The \* option is omitted.
- Depending on the network environment, resolution, image quality, number of simultaneous accesses, etc., the image update rate may be lower than the set value.
- If the image is not delivered at the set image update rate, you can reduce the resolution and image quality to close to the set value.
- The updating speed up to the value of the selected imaging mode can be selected.

## JPEG

Here, the **Image capture size** and **Image quality** of JPEG is set. For settings for H.265 (or H.264) images, see below.

→[Configuring streaming options, p. 177](#)

#### NOTE!

<Multisensor>: This setting is common to all cameras.

### Image capture size

When displaying JPEG images, select the resolution of the images to be displayed.

### PTZ camera

Image capture mode	JPEG1	JPEG2
2 megapixels [16:9] (60 fps mode)	1920x1080	640x360
2 megapixels [16:9] (50 fps mode)	1280x720	
2 megapixels [16:9] (30 fps mode)	640x360	
2 megapixels [16:9] (25 fps mode)	320x180	
2 megapixels [4:3] (30 fps mode)	1280x960	640x480
2 megapixels [4:3] (25 fps mode)	640x480	
	320x240	
2 megapixels [4:3] (15 fps mode)	2048x1536	640x480
2 megapixels [4:3] (12.5 fps mode)	1280x960	
	640x480	
	320x240	

---



## Multisensor camera

Image capture mode	JPEG1	JPEG2
5 megapixels [16:9] (15 fps mode)	3072x1728	–
5 megapixels [16:9] (12.5 fps mode)	2560x1440	
	1920x1080	
	1280x720	
	640x360	
	320x180	
5 megapixels [16:9] (15 fps Quad mode)	3072x1728	–
5 megapixels [16:9] (12.5 fps Quad mode)	2560x1440	
	1920x1080	
	1280x720	
	640x360	
5 megapixels [4:3] (15 fps mode)	3072x2304	–
5 megapixels [4:3] (12.5 fps mode)	2560x1920	
	1280x960	
	640x480	
	320x240	
5 megapixels [4:3] (15 fps Quad mode)	3072x2304	–
5 megapixels [4:3] (12.5 fps Quad mode)	2560x1920	
	1280x960	
	640x480	

### Image quality

Set the quality of JPEG images for each resolution.

**0 Super fine/1 Fine/2/ 3/ 4/ 5 Normal/6/ 7/ 8/ 9 Low**

## Configuring streaming options

Click on the **Image** tabs of the video and audio pages. Refer to the following how to display and operate the **Detailed settings** menu.

→[Accessing the camera settings menu, p. 109](#)

→[Editing the camera settings, p. 111](#)

## Detailed settings

### Configuring image and audio options for recordings

---

This page allows choosing H.265/H.264 images and selecting the **bit rate per client**, **Image capture size**, **Image quality** options, for example.

For JPEG image options, refer to the following.

→[Configuring JPEG image options, p. 174](#)

## Stream

A stream is a continuous flow of video and audio data.

### NOTE!

The number of streams depends on the camera model.

## Stream transmission

Use **On** or **Off** to set whether to deliver H.265 (or H.264) images.

- **On:** Deliver H.265 (or H.264) images.
- **Off:** The H.265 (or H.264) image is not delivered.

### NOTE!

- If you set **Stream transmission** to **On**, you can view both H.265 (or H.264) and JPEG images on live picture pages.
- If one of the streams' **Stream transmission** is set to **On**, the image update rate of the JPEG image is limited.
- For information about the rate of updating JPEG images when **Stream transmission** is set to **On**, see below.
- →[View camera images, p. 42](#)
- <Multisensor>: If any one of the **Stream transmission** cameras is set to **On**, the image updating rate of the JPEG image is limited.
- <Multisensor>: This setting can be set individually by each camera.

## Stream encoding format

Select the compression method for the stream to be delivered.

### NOTE!

<Multisensor>: This setting is common to all cameras.

## Image capture size

Select the resolution of the H.265 (or H.264) image from the following. Selection may be limited depending on the selected resolution.

Please refer to the following for the relationship between your model and symbols and terminology.

→[Compatible models and symbols in this manual](#)

### PTZ camera

Image capture mode	H.265/H.264			
	Stream 1	Stream 2	Stream 3	Stream 4
2 megapixels [16:9] (60 fps mode)	1920x1080	1920x1080	1280x720	640x360
2 megapixels [16:9] (50 fps mode)	1280x720	1280x720	640x360	320x180
2 megapixels [16:9] (30 fps mode)	640x360	640x360	320x180	
2 megapixels [16:9] (25 fps mode)	320x180	320x180		
2 megapixels [4:3] (30 fps mode)	1280x960	1280x960	640x480	640x480
2 megapixels [4:3] (25 fps mode)	640x480	640x480	320x240	320x240
	320x240	320x240		
2 megapixels [4:3] (15 fps mode)	2048x1536	1280x960	640x480	640x480
2 megapixels [4:3] (12.5 fps mode)		640x480	320x240	320x240
		320x240		

### Multisensor camera

Image capture mode	H.265/H.264			
	Stream 1	Stream 2	Stream 3	Stream 4
5 megapixels [16:9] (15 fps mode)	3072x1728	1280x720	–	–
5 megapixels [16:9] (12.5 fps mode)	2560x1440	640x360		
	1920x1080	320x180		
5 megapixels [16:9] (15 fps Quad mode)	3072x1728	1280x720	–	–
5 megapixels [16:9] (12.5 fps Quad mode)	2560x1440	640x360		
5 megapixels [4:3] (15 fps mode)	3072x2304	1280x960	–	–
5 megapixels [4:3] (12.5 fps mode)	2560x1920	640x480		
		320x240		
5 megapixels [4:3] (15 fps Quad mode)	3072x2304	1280x960	–	–
5 megapixels [4:3] (12.5 fps Quad mode)	2560x1920	640x480		

## Detailed settings

### Configuring image and audio options for recordings

---

#### NOTE!

- If **Image rotation** is set to **90°** or **270°** on the **Basic** tabs of the basic pages, the resolution **320x180** cannot be set.
- <Multisensor>: This setting is common to all cameras.
- <Multisensor>: When Stream (1) is 2688x1520 and Stream (2) is 1280x720, the frame rate is limited to a maximum of 15fps (maximum 12.5fps in 25fps mode).

## Transmission priority

Set the stream delivery mode from the following.

- **Constant bit rate**: The H.265 (or H.264) images are delivered at the bit rate set by **Max bit rate (per client)\***.
- **VBR**: The H.265 (or H.264) images are delivered at the frame rate set by **Frame rate\*** while maintaining the image quality level set by **Image quality**. At this time, the bit rate is varied within the maximum bit rate set by **Max bit rate (per client) \***. The recording capacity varies depending on the **Image quality** settings and subject conditions.
- **Frame rate** Deliver H.265 (or H.264) images at the frame rate set by **Frame rate\***.
- **Best effort** The H.265 (or H.264) images are delivered with varying bit rates within the maximum bit rate set by **Max bit rate (per client) \***, depending on the bandwidth of the networks.

#### NOTE!

- Setting **Transmission priority** to **Frame rate** may result in fewer users being able to connect.
- <Multisensor>: This setting is common to all cameras.

## Frame rate\*

Set the frame rate from the following.

- For 16:9 mode(30fps mode)/16:9 mode(60fps mode)/4:3 mode(30fps mode)/4:3 mode(15fps mode):  
1fps/ 3fps/ 5fps/ 7.5fps/ 10fps/ 12fps/ 15fps/ 20fps/ 30fps/ 60fps
- For 16:9 mode(25fps mode)/16:9 mode(50fps mode)/4:3 mode(25fps mode)/4:3 mode(12.5fps mode):  
1fps/ 3.1fps/ 4.2fps/ 6.25fps/ 8.3fps/ 12.5fps/ 20fps/ 25fps/ 50fps

**NOTE!**

- **Frame rate\*** is restricted to **Max bit rate (per client) \***. When a value with \* is set, the frame rate may be lower than the set value. If **Transmission priority** is set to **VBR**, the image may be suspended periodically depending on the **Max bit rate (per client) \*** and **Image quality** settings. Confirm the image delivered after setting.
- The \* option is omitted.
- The frame rate up to the value of the selected imaging mode can be selected.
- Depending on the number of concurrent users or the combination of functions used, the frame rate may be lower than the set value. Confirm the image delivered after setting.
- If the frame rate is set low, the image may not be displayed properly depending on the web browser you use.
  - 60 fps can be selected only when **Image capture mode** is in **16:9 mode (60 fps mode)**. In this case, stream (1) will be **fixed at 60 fps**. **Stream(2) ~ Stream(4)** can be up to 10 fps.
  - 50 fps can be selected only when **Image capture mode** is in **16:9 mode (50 fps mode)**. In this case, stream (1) is set to **Fix 50fps**. **Stream(2) ~ Stream(4)** can be up to 8.3 fps.
- <Multisensor>: This setting is common to all cameras.

**Max bit rate (per client) \***

Select H.265 (or H.264) bit rate for one client from the following.

64kbps/128kbps \*/ 256kbps \*/ 384kbps \*/ 512kbps \*/ 768kbps \*/ 1024kbps \*/ 1536kbps \*/ 2048kbps \*/ 3072kbps \*/ 4096kbps \*/ 6144kbps \*/ 8192kbps \*/ 10240kbps \*/ 12288kbps \*/ 14336kbps \*/ 16384kbps \*/ 20480kbps \*/ 24576kbps \*/---free input

If --- is selected, the bitrate can be entered freely to the extent that it can be set.

**Transmission priority**

If **Transmission priority** is **Constant bit rate**, **Frame rate**, or **Best effort**

- 320x180, 640x360, QVGA, VGA: 64 kbps to 4096 kbps \*
- 1280x720<sup>\*1</sup>For 1280 x 960: 128 kbps \*~ 8192 kbps \* 1920x1080<sup>\*1</sup>For: 256 kbps \*~ 12288 kbps \*
- For 2048 x 1536: 512 kbps \*~ 16384 kbps \*
- For 2560 x 1440, 2560 x 1920: 768 kbps \*~ 24576 kbps \*
- For 3072 x 1728: 1024 kbps \*~ 24576 kbps \*
- For 3072 x 2304: 1536 kbps \*~ 24576 kbps \*
- 3840 x 2160: 2048 kbps \*~ 24576 kbps \*

## Detailed settings

### Configuring image and audio options for recordings

---

#### If **Transmission priority** is **VBR**

- 320x180, 640x360, QVGA, VGA: 64 kbps to 12288 kbps \*
- 1280x720<sup>\*1</sup>For 1280 x 960: 128 kbps \*~ 12288 kbps \* 1920x1080<sup>\*1</sup>In the case: 256 kbps \*~ 24576 kbps \* For 2048 x 1536: 512 kbps \*~ 24576 kbps \*
- For 2560 x 1440, 2560 x 1920: 768 kbps \*~ 24576 kbps \*
- For 2688 x 1520: 768 kbps to 24576 kbps
- For 3072 x 1728: 1024 kbps \*~ 24576 kbps \*
- For 3072 x 2304: 1536 kbps \*~ 24576 kbps \*
- For 3840 x 2160: 2048 kbps \*~ 24576 kbps \*

#### NOTE!

- The bit rate of streams is restricted to **Bandwidth control(bit rate)** on the **Network** tabs of network pages. Therefore, when the value with \* is set, the image may not be delivered.  
→[Basic network settings, p. 309](#)
- It is recommended that the bit rate of the stream be set to 8192 kbps or less. If a value greater than 8192 kbps is set, the continuity of recorded images may be abnormal.
- When the refresh interval is short, the bit rate may be exceeded depending on the subject.
- Depending on the number of concurrent users or the combination of functions used, the bit rate may be lower than the set value. Confirm the image delivered after setting.
- If you use **60fps mode** or **50fps mode** at the resolution of \*1, you can set up to 24576 kbps.
- <Multisensor>: This setting is common to all cameras.

## Image quality

Select the image quality for the H.265 (or H.264) image from the following.

For **Constant bit rate, Frame rate, Best effort**: Movement priority/Standard/Image quality priority

For **VBR**: **0 maximum image quality/1 Fine/2/3/4/5 Normal/6/7/8/9 Low**

## Auto VIQS

Auto VIQS uses high bit rates for image areas that are changing and low bit rates for areas with little or no changes.

- **Off**: Disables **Auto VIQS**.
- **On**: Enables **Auto VIQS**.

## Smart VIQS

Images are distributed so that the amount of data decreases while maintaining high image quality in areas with objects (head, people, cars and motorcycles) and low/medium/medium image quality in other areas.

- **Off:** Do not use Smart VIQS.
- **On(High):** Images are distributed so that the image quality in the area where the object (head, people, automobiles, and motorcycles) is located is maintained at a high level, while the image quality in other areas is maintained at a low level and the amount of data is reduced.
- **On(Low):** Images are distributed so that image quality is high in areas with objects (head, people, cars, and motorcycles) and medium image quality is maintained in other areas while data volume is low.

### NOTE!

- This function can be used with **Stream(1)** only. If **On(High)** or **On(Low)** is selected, the VIQS settings are disabled from the **Image quality** tabs.
- **MULTI\_4/MULTI\_3.** When **Smart VIQS** is set to **On(High)** or **On(Low)**, the frame rate is limited to 7.5 fps maximum in 15 fps mode, 6.25 fps maximum in 12.5 fps mode, 15 fps maximum in 30 fps mode, and 12.5 fps maximum in 25 fps mode

## Smart P Picture control

To reduce the amount of data, **Smart P Picture control** reduces the generation of data (macroblock) as much as possible except where there is an object (head, person, car, or motorcycle).

- **Off:** **Smart P Picture control** is not used.
- **On:** In order to reduce the amount of data, P-picture data is controlled to be generated as little as possible in areas other than those with an object (head, person, car, or motorcycle).

### NOTE!

- This function can be used with **Stream(1)** only. If **On** is selected, the VIQS settings are disabled from the **Image quality** tabs.
- When **On** is selected, movement may not be smooth or noise may be generated in areas without objects (heads, people, cars, and motorcycles).
- **MULTI\_4/MULTI\_3:** When **Smart P Picture control** is used, the frame rate is limited to 7.5 fps maximum in 15 fps mode, 6.25 fps maximum in 12.5 fps mode, 15 fps maximum in 30 fps mode, and 12.5 fps maximum in 25 fps mode

## GOP control

GOP control reduces the amount of data.

- If **H.265** is selected in **Stream encoding format: Off/Low/Mid/Advanced/Frame rate control**
- If **H.264** is selected in **Stream encoding format: Off/Low/Mid(variable GOP 4s-16s)**

**CAUTION!** When **Low, Mid, Mid, or Frame rate control (Variable GOP4s-16s + Frame rate control)** is selected, recording cannot be performed on the SD card. If **Advanced (fixed GOP 60s + 1s keyframe)** is selected, the data can be recorded on SD cards only with **ManualSchedule**.

### NOTE!

- Using GOP control increases the refresh interval for the H.265 (or H.264) image. Therefore, do not use in network environments where there are many errors.
- **Low/Mid/Frame rate control (variable GOP4s-16s + frame rate control)** can be set only when **VBR** is selected in **Transmission priority**. **Advanced (Fixed GOP 60s + 1s keyframe)** can be set regardless of the **Transmission priority**.
- **Low (variable GOP 1s-8s), Mid (variable GOP 4s-16s), and Frame rate control (variable GOP 4s-16s + frame rate control)** can reduce the amount of data when there is no detectable object (face, person, car, or motorcycle) in the image. **Advanced (fixed GOP 60s + 1s keyframe)** reduces the amount of data regardless of the presence or absence of the sensing object.
- When **Frame rate control** is set, the frame rate can be changed from 1fps to **Frame rate\*** depending on the presence or absence of the sensing object.
- When **Frame rate control** is set, the display may temporarily slow or fast when the frame rate is switched.
- <Multisensor>: When **GOP control** is set to **Low(Variable GOP 1s-8s), Mid (Variable GOP 4s-16s), Advanced(Fixed GOP 60s w/1s key-frame) or Frame rate control(Variable GOP 4s-16s w/frame rate control)** is selected, the bit rate will be limited.
- **MULTI4/MULTI3: GOP control** is set to **Low(Variable GOP 1s-8s), Mid(Variable GOP 4s-16s) or Frame rate control(Variable GOP 4s-16s w/frame rate control)**, the frame rate is limited to 7.5 fps maximum in 15 fps mode, 6.25 fps maximum in 12.5 fps mode, 15 fps maximum in 30 fps mode, and 12.5 fps maximum in 25 fps mode.

## Refresh interval

Select the refresh interval (I-Picture interval: 0.2 to 5 seconds) for the H.265 (or H.264) image from the following.



If there are many errors in the network environment, the image will be less distorted if the refresh interval is shortened.

However, the updating speed of the image may decrease or the bit rate may be exceeded

**0.2s/ 0.25s/ 0.33s/ 0.5s/ 1s/ 2s/ 3s/ 4s/ 5s**

**NOTE!**

- If **GOP control** is set to Low (variable GOP 1s-8s), the refresh interval is set to 8s.
- If **GOP control** is set to Mid (variable GOP 4s-16s), the refresh interval is set to 16s.
- If **GOP control** is set to Advanced (fixed GOP 60s + 1s keyframe), the refresh interval is set to 60s.
- If **GOP control** is set to **Frame Rate Control (variable GOP 4s-16s + frame rate control)**, the frame rate can be varied between values set from 1fps to **Frame rate\*** according to the magnitude of the image change. The lower the frame rate, the longer the refresh interval. The maximum refresh interval is 16s.
- <Multisensor>: This setting is common to all cameras.

## Transmission type

Select the distribution method of H.265 (or H.264) image from the following.

- **Unicast port (AUTO)**

When sending images and sounds from your computer, **Unicast port1(Image)** and **Unicast port2(Audio)** are automatically set. If you do not need to fix the number of the ports on which the streams are delivered, such as when used in networks, it is recommended that you set it to **Unicast port (AUTO)**.

- **Unicast port (MANUAL)**

When sending images and audio from the computer, the **Unicast port1(Image)** and **Unicast port2(Audio)** must be set manually. When accessing a camera using a browser, the port number is automatically selected even in this setting. When distributing a stream over the Internet, fix the port number to be used as the Broadband Router (hereinafter referred to as the Router). For details, refer to the router's instruction manual.

→[Basic network settings, p. 309](#)

- **Multicast**

You can access this machine at the same time without restricting the number of people. To send streams in multicast, enter **Multicast address**, **Multicast port**, and **Multicast TTL/HOPLimit**.

## Detailed settings

### Configuring image and audio options for recordings

---

#### NOTE!

- For the maximum number of simultaneous unicast accesses, see the following.  
→[View camera images, p. 42](#)
- If **Unicast port (MANUAL)** is selected, you must configure a unicast port number.
- When multicast is set, the browser will not be able to view the H.265 image (or H.264 image).
- If **Multicast** is selected, you must configure multicast IP addresses.
- <Multisensor>: This setting is common to all cameras.

#### Unicast port1(Image)

Enter the unicast port number (used to send images from your computer).

**Configurable port number:** 1024 to 50000 (even number only)

#### Unicast port2(Audio)

Enter the unicast port number (to be used when sending audio from your computer).

**Configurable port number:** 1024 to 50000 (even number only)

#### Multicast address

Enter the multicast IP address.

Send images and sound to the specified IP address.

- **IPv4 configurable range:** 224.0.0.0~239.255.255.255
- **IPv6 configurable range:** Multicast addresses starting with FF

#### NOTE!

Check and enter the available multicast IP address.

#### Multicast port

Enter the multicast port number (used when sending images from your computer).

**Configurable port number:** 1024 to 50000 (even number only)

#### NOTE!

When sending audio from your computer, the multicast port number plus **1000** is used.

#### Multicast TTL/HOPLimit

Enter the TTL/HOPLimit value for the multicast.

**Value range:** 1~254

**CAUTION!**

- When delivering a stream over the Internet, the distribution image may not be displayed depending on the settings of the proxy server, firewall, etc. In this case, contact your network administrator.
- If you want to display multicast images using a PC with multiple LAN cards, disable LAN cards that are not used for reception.

## Configuring image quality

Click on the **Image quality** tabs of the video and audio pages. Refer to the following how to display and operate the **Detailed settings** menu.

→[Accessing the camera settings menu, p. 109](#)

→[Editing the camera settings, p. 111](#)

To Advanced Settings for each item > >Clicking this button displays the **Detailed settings** menus window in a separate window and allows you to set the settings while viewing the images displayed on the **Image quality** tab.

You can set the image quality adjustment, zoom/focus, privacy zone, VIQS, and lens distortion compensation.

## Detailed settings

### Configuring image and audio options for recordings

Image      **Image quality**



Cam. 1 ▾

Image adjust		Setup >>
Extra zoom		Setup >>
Privacy zone		Setup >>
VIQS		Setup >>
Lens distortion compensation		Setup >>

Selecting the camera from the pull-down menu at the bottom of the screen displays the live picture of the selected camera. You can view the image quality adjusted on this screen.

#### **NOTE!**

<Multisensor>: Only Multisensor cameras can be selected.

#### **Image adjust**

When the **button** is clicked, the image quality setting window is displayed in a separate window.

→[Adjusting the image quality, p. 189](#)

#### **Extra zoom**

When the button is clicked, the EX zoom setting window is displayed in a separate window.

→[Adjust the angle of view with the EX zoom, p. 204](#)

### Zoom/focus adjustment

When the button is clicked, the zoom and focus settings window is displayed in a separate window.

→[Adjusting the zoom/focus, p. 205](#)

### Privacy zone

Click the **Privacy Zone** button to open the Privacy Zone Settings window.

→[Setting the privacy zone \(Privacy zone setting screen\), p. 210](#)

### VIQS

Click the **VIQS** button to display the VIQS settings window.

→[Set up VIQS, p. 215](#)

### Lens distortion compensation

Click this button to display the setting window for lens distortion compensation in a separate window.

→[Set the lens distortion compensation, p. 223](#)

#### NOTE!

<PTZ>: See the following for the operation of the zoom function of the PTZ camera.

→[Configuring PTZ camera functions, p. 227](#)

## Adjusting the image quality

In the **Video/Audio > Image quality** tabs to **Image adjust**, click on **Detailed settings** menu.

→[Configuring image quality, p. 187](#)

Image quality is set in the setting screen displayed in a separate window. When you change the values, the values are displayed in the **Image quality** tabs

The image you have also reflects the changes you made.

- Click + on the left side of each item in the setting screen to expand each item and display detailed settings.
- Click-> on the left of each expanded item to return to the previous window.

## Detailed settings

### Configuring image and audio options for recordings

#### Example: Basic image quality adjustment

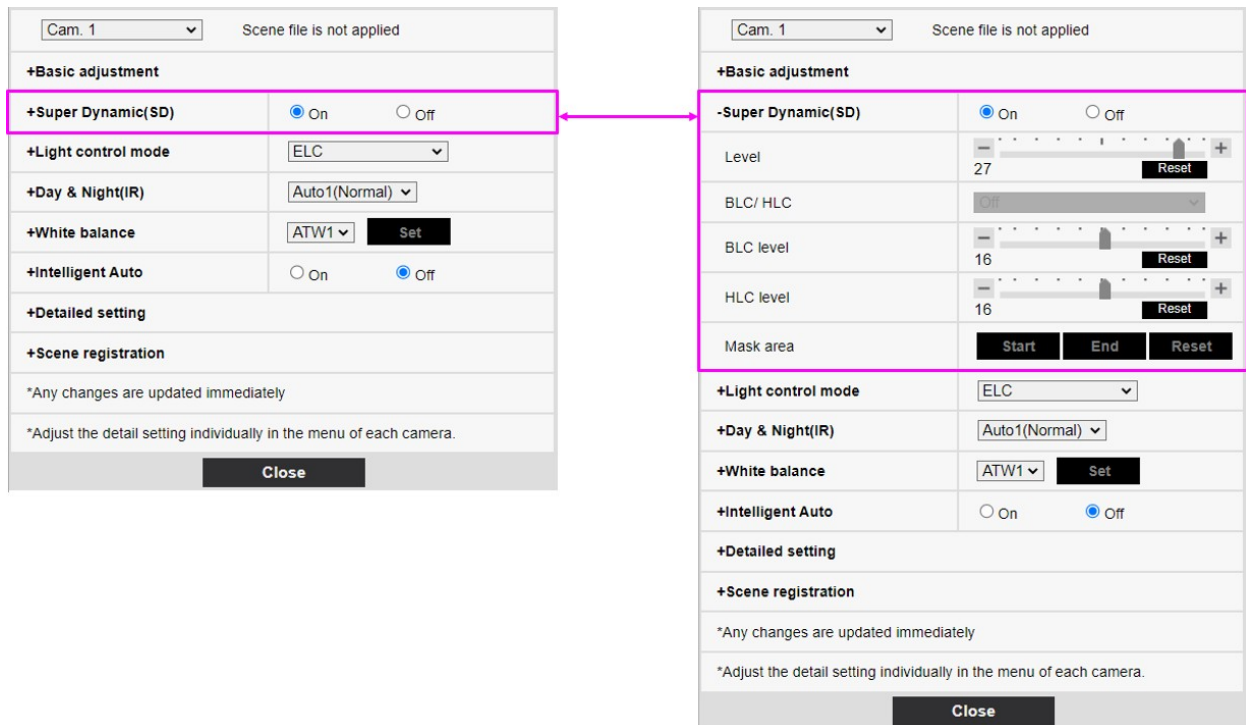

## Camera selection

Select the camera that reflects the image quality settings.

- **Common(Cam. 1-4):** The settings are made simultaneously for each camera. The images displayed on the **Image quality** tabs are divided into cameras.
- **Camera *n*:** Sets the image quality for camera *n*. The corresponding image is displayed on the **Image quality** tab.

### NOTE!

- <Multisensor>: **Camera selection** can be selected only for Multisensor cameras.
- <Multisensor>: For **Common(Cam. 1-2)**, for **Super Dynamic**, **Light control mode**, **White balance**, and **Intelligence Auto**, only items can be set up prior to the **Detailed settings** menus. To perform other **Detailed settings** menus, select each camera.

## Basic Image Quality Adjustments

### Brightness

Adjust the brightness.

Move the slider bar in the + direction to brighten the image. Move the slider bar in the - direction to darken the image. Press **Reset** to return to the default brightness.

## Maximum gain

Adjust the maximum gain. When the subject's illumination becomes dark, the gain automatically increases and the screen brightens.

Increasing the gain may increase the noise.

Move the slider bar in the + direction to increase the maximum gain. Move the slider bar in the - direction to reduce the maximum gain. Press **Reset** to return to the default settings.

## Chroma gain level

Adjust the chroma level (color intensity).

When the slider bar is moved in the + direction, it becomes bright and bright. When the slider bar is moved in the - direction, the color becomes calm.

- Press **Reset** to return to the default settings.

## Sharpness level

- Adjust the sharpness level (contour correction).
- Moving the slider bar in the direction of + results in a sharp contour, while moving the slider bar in the direction of - results in a soft contour.
- Press **Reset** to return to the default settings.

## Digital noise reduction

- The digital noise reduction function automatically reduces noise at low illumination levels. Move the slider bar in the direction of + to increase the effect of noise reduction.
- Moving the slider bar in the direction of - reduces the noise reduction effect. There are fewer aftereffects.
- Press **Reset** to return to the default settings.

## Superdynamic Settings

### Super Dynamic

You can set **On** or **Off** to activate the super dynamic function. See **What is Super Dynamic** for details on super dynamic.

- **On:** The Super Dynamic function is activated.
- **Off:** Stops the superdynamic function.

## Detailed settings

### Configuring image and audio options for recordings

---

#### NOTE!

- This cannot be set when **Image capture mode** is **16:9 mode(60fps mode)** or **16:9 mode (50fps mode)**.
- Set **Super Dynamic** to **Off** when the following phenomena are observed depending on the lighting condition.
  - when flickering or color changes occur
  - when noise is generated in the bright area of the screen
- If **Light control mode** is set to **Fix shutter**, **Super Dynamic** cannot be set to **On**.
- When **Stabilizer** is set to **On**, the superdynamic setting is **Off**.

## Level

Adjust the superdynamic level.

When the slider bar is moved in the + direction, you can shoot a subject with a large difference in light and darkness without flipping white or shading black.

- Move the slider bar in the - direction to take a full picture of the middle brightness.
- Press **Reset** to return to the default settings.

## What is Superdynamic?

If there is a large difference between the bright and dark areas, the camera will set the lens aperture to match the bright areas, making the dark areas invisible. Conversely, when the lens aperture is adjusted to the dark area, the bright area is not visible.

Super Dynamic is a function of combining images with large brightness and darkness, and images with large darkness, and reproducing brightness and darkness faithfully.



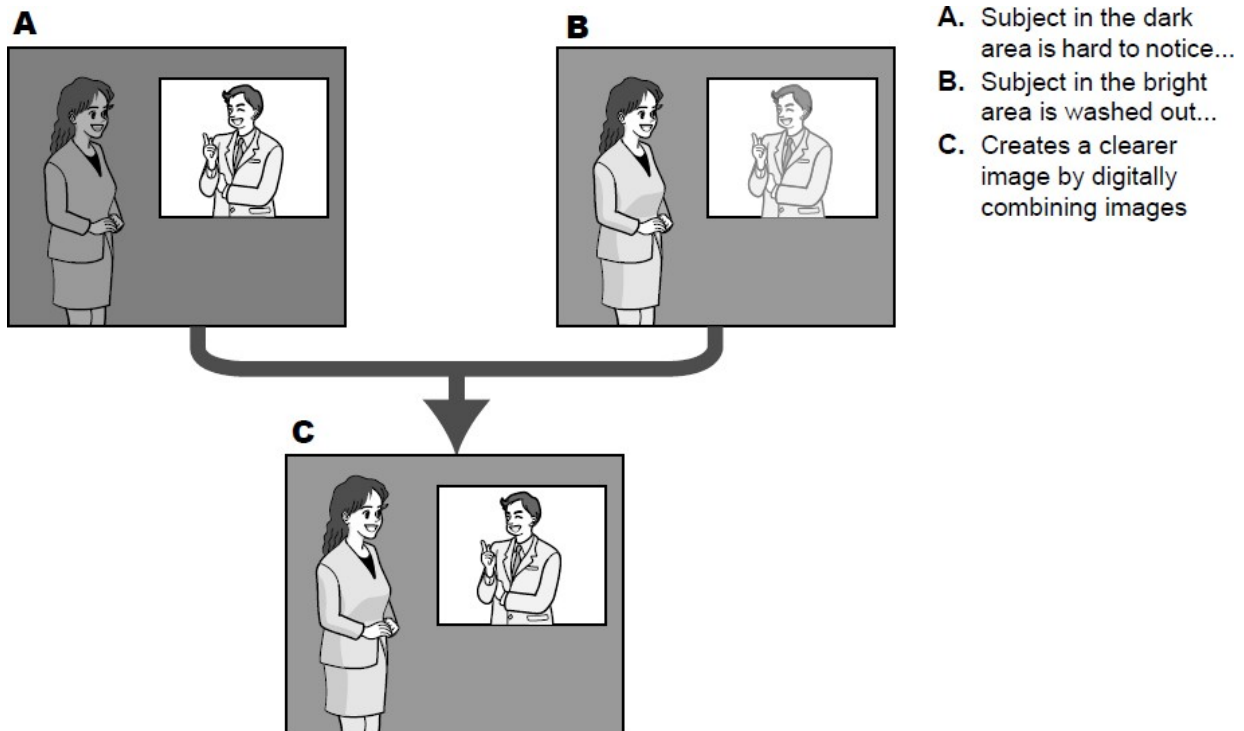

### BLC/HLC

Select from the following. This setting is not available if **Super Dynamic** is set to **On** or **Intelligent Auto** is set to **On**.

- **Back light compensation(BLC):** Enables the backlight correction function.
- **High light compensation(HLC):** Enables the high light correction function. Illumination compensation suppresses bright lighting of subjects such as car headlights during nighttime.

**Off:** Stops the backlight compensation function and the intense light correction function.

### BLC level

Adjust the backlight correction level.

Moving the slider bar in the **+** direction improves the backlight correction effect. Moving the slider bar in the **-** direction reduces the effect of backlight correction.

Press **Reset** to return to the default settings.

### HLC level

Adjust the intensity correction level.

Moving the slider bar in the **+** direction improves the effect of intense light correction. Moving the slider bar in the **-** direction reduces the effect of intense light correction.

Press **Reset** to return to the default settings.

## Detailed settings

### Configuring image and audio options for recordings

---

#### Mask area

When the mask area is set, the set area can be masked and the light intensity can be adjusted. If

**Super Dynamic** is set to **On**, it cannot be set.

For details on how to set the mask area, refer to the following.

→[Setting mask areas, p. 201](#)

#### NOTE!

<Multisensor>: When **Common(Cam. 1-2)** is selected in **Camera selection**, the mask area cannot be set. Set for each camera.

## Light intensity control mode

### Light control mode

Select the mode to control the light intensity from the following.

**Outdoor scene**: The brightness (illumination) controls the light intensity by combining the electronic shutter and automatic aperture. This setting is used when shooting bright subjects such as outdoors. Be careful not to flicker under fluorescent lights, etc.

**Flickless (50 Hz)/Flickless (60 Hz)**: Flicker is automatically corrected with a fluorescent lamp. 50 Hz/60 Hz will be used differently in different regions.

**ELC**: The electronic shutter is used to control the light intensity.

#### NOTE!

- If you increase the shutter speed (~1/10,000), you will be less prone to blur even when the subject moves faster.
- Increasing the shutter speed decreases the sensitivity.
- If **Super Dynamic** is set to **On**, **Fix shutter** cannot be set.
- If **Image capture mode** is **Single source [4:3(25fps mode)]**, **50fps mode**, or **Dual sources [4:3(12.5fps mode)]**, **Flickerless 60Hz** cannot be set.
- When **25fps mode**, **50fps mode**, or **12.5fps mode** is selected for **Image capture mode**, **Indoor scene(60 Hz)** is not available.
- It may be able to reduce flickering by switching the **Image capture mode** as follows:
  - In the area where the power frequency is 60Hz: Switch the **Image capture mode** to 30 fps mode or 15 fps mode.
  - In the area where the power frequency is 50Hz: Switch the **Image capture mode** to 25 fps mode or 12.5 fps mode.

## Maximum shutter

The maximum exposure time adjusts the maximum storage time of the sensor.

When **Maximum shutter** is set to the following, the frame rate may decrease when the subject is dark.

If the **Image capture mode** is in 30 fps or 15 fps mode:

- Value longer than **1/30s maximum (2/30s maximum/4/30s maximum/6/30s maximum/10/30s maximum/16/30s maximum)**
- If the **Image capture mode** is in 25 fps or 12.5 fps mode:
- Value longer than **1/25s maximum (2/25s maximum/4/25s maximum/6/25s maximum/10/25s maximum/16/25s maximum)**
- <Multisensor>: If the frame rate is lowered for one or more cameras due to the above, the frame rate is lowered for the other cameras whose exposure time has not changed.

### NOTE!

- If **Super Dynamic** is set to **On**, **Maximum 1/2000 s**, **Maximum 1/4000 s**, or **Maximum 1/10000 s** cannot be set.
- If **Maximum gain** is set to **0**, the **Maximum shutter** setting is restricted as follows.
- If **Image capture mode** is set to **Single source [4:3(30fps mode)]/60fps mode/Dual sources [4:3(15fps mode)]**:
  - **Maximum 2/30s** or more cannot be set.
- If **Image capture mode** is set to **Single source [4:3(25fps mode)]/50fps mode/Dual sources [4:3(12.5fps mode)]**:
  - **Maximum 2/25s** or more cannot be set.
- If **Light control mode** is set to **Flickless (60Hz)**, the duration cannot be set to less than **1/120s**.
- If **Light control mode** is set to **Flickless (50Hz)**, the duration cannot be set to less than **1/100s**.

## Light control speed

Adjust the speed of light intensity adjustment.

Move the slider bar in the **+** direction to increase the speed of light adjustment. Moving the slider bar in the **-** direction slows the light intensity adjustment speed. Press **Reset** to return to the default settings.

## Switching between black and white

### D&N

Select the mode for switching between black-and-white and color images.

- **Off:** It is always shot with color images.
- **On:** The picture is always taken in black and white.
- **Auto1(Normal):** The color image and black-and-white image are automatically switched depending on the brightness (illumination) of the image.
- **Auto2(IR Light):** The color image and black-and-white image are automatically switched depending on the brightness (illumination) of the image. This setting is used when near-infrared lighting is used at night.
- **Auto3(SCC):** Set this when you want to maintain a color image even when the light source is dark. The Super Chroma Compensation (SCC) function maintains the color image to low illumination.

### What is Super Chroma Compensation (SCC)?

This function enables the acquisition of color images that are faithful using a unique color correction technology even in an environment with low illumination that cannot capture images faithfully.

#### NOTE!

- The Auto3 (Super Chroma Compensation) setting uses color correction techniques and may be displayed differently from the Full object depending on the ambient illumination condition.
- The operation sound may be heard when switching between black and white. However, this is not an error.
- Automatic color/black-and-white image switching may not work depending on the environment. In this case, use the scheduling function to change the color image/black-and-white image.
- <Multisensor>: If **D&N** is set to other than **Off**, all cameras will be changed to the same setting.
- **Rapid PTZ: Auto3(SCC)** cannot be selected.

### Level

Select the brightness (illumination) level to switch between color image and black-and-white image from the following. The following switching illuminance is the illuminance when [Super Dynamic] is **Off**.

- 3: The brightness (brightness) of the camera is about 8 lx or less, and the image is switched to black and white.
- 2: The brightness (brightness) around the camera is about 4 lx or less, and the camera switches to a black-and-white image.
- 1: The brightness (brightness) of the camera is about 2 lx or less and the image is switched to black and white.
- 0: The brightness (brightness) around the camera is about 1 x or less, and the image is switched to black and white.

**NOTE!**

The color image switching is about 5 to 8 times bright. It may vary depending on the environment. If **Maximum gain** is set low, it may not be easy to switch over depending on the environments.

**Dwell time**

Select the time before switching between color image and black-and-white image from the following. **2s/ 10s/ 30s/ 1min**

**Adjusting white balance****White balance**

Select the white balance adjustment method from the following.

Adjust the white color with the R volume (adjusting red color) or the B volume (adjusting blue).

- **ATW1:** Set the automatic color temperature tracking mode. The camera continuously checks the color temperature of the light source and automatically adjusts the white balance. The operating range is about 2700 K to 6000 K.
- **ATW2:** Set the automatic color temperature tracking mode under sodium lamp. The camera automatically adjusts the white balance under the sodium lamp. The operating range is from about 2000 K to 6000 K.
- **AWC:** Set the automatic white balance control mode. Since the light source is fixed, it is suitable for shooting where the light source does not change. The operating range is from approximately 2000 K to 10000 K.

**NOTE!**

- Colors may not be reproducible faithfully if the following conditions are met: In such cases, set it to **AWC**.
- Most dark-colored subjects
- The outgoing blue sky and the evening sun Subject with too low illumination
- If **AWC** is selected, press **Set**.

## Detailed settings

### Configuring image and audio options for recordings

---

#### Red gain

Adjusts the red color of the image.

Move the slider bar in the + direction to darken the red color. When the slider bar is moved in the - direction, the red color becomes light. Press **Reset** to return to the default settings.

#### Blue gain

Adjust the blue color of the image.

Move the slider bar in the + direction to darken the blue color. When the slider bar is moved in the - direction, the blue color becomes light. Press **Reset** to return to the default settings.

#### Mask area

When the mask area is set, the set area can be masked and the white balance can be adjusted. For details on how to set the mask area, refer to the following.

→[Setting mask areas, p. 201](#)

#### NOTE!

<Multisensor>: When **Common(Cam. 1-2)** is selected in **Camera selection**, the mask area cannot be set. Set for each camera.

#### Adjustment speed

Adjust the white balance adjustment speed.

Move the slider bar in the + direction to increase the white balance adjustment speed. Move the slider bar in the - direction to slow the white balance adjustment speed. Press **Reset** to return to the default settings.

## Using Intelligent Auto

Set ON/OFF whether the intelligent auto function is enabled or not.

Intelligent Auto identifies scenes (backlights, outdoors, night scenes, etc.), faces, moving objects, etc., and automatically squeezes the camera to adjust the gain, shutter speed, and contrast to make it easier to see faces and moving objects.

#### What is Intelligent Auto?

This function enables the camera to adjust the gain, shutter speed, and contrast by identifying scenes (backlight, outdoors, night scenes, etc.), faces of people, and moving objects, thereby making it easier to see faces and moving objects.

#### Face priority level (Brightness)

Adjust the face priority level when activating intelligent auto.

Move the slider bar in the + direction to make the face more visible.

Move the slider bar in the - direction to adjust the entire image in a balanced manner. Press **Reset** to return to the default settings.

### Motion priority level (Shutter)

Adjust the motion priority level when activating intelligent auto.

Moving the slider bar in the + direction makes moving subjects less prone to blurring but increases dark subject noise.

Moving the slider bar in the - direction tends to blur the moving subject but reduces the dark subject noise. Press **Reset** to return to the default settings.

#### NOTE!

- Flicker caused by fluorescent lamp may occur when intelligent auto is activated. In this case, set one of the following settings.
- Adjust the **Motion priority level** slider bar to -.
- Change **Light control mode** to **Indoor scene(50Hz)** or **Indoor scene(60Hz)**.
- When intelligent auto is activated, the brightness of the entire image may change due to changes in some subjects. In such cases, adjust the **Face priority level** slider bar to -.
- **MULTI\_4/MULTI\_3** When intelligent auto is activated, the maximum frame rate is limited to 7.5 fps in 15 fps mode and 6.25 fps in 12.5 fps mode regardless of the frame rate.

## Detailed settings menus

### Auto contrast adjust

Use **On** or **Off** to set the auto-contrast adjust function. **On**: Activate the automatic contrast adjustment function. **Off**: Stops the automatic contrast adjustment function.

#### NOTE!

If **Intelligent Auto** is set to **On**, this item cannot be set.

### Contrast level

Adjust the contrast intensity.

Move the slider bar in the + direction to increase the contrast of the image. Move the slider bar in the - direction to reduce the image contrast.

Press **Reset** to return to the default settings.

#### NOTE!

If **Fog compensation** is set to **On**, this item cannot be set.

### Adaptive black stretch

Adjust the brightness of the dark area of the image.

## Detailed settings

### Configuring image and audio options for recordings

---

Move the slider bar in the + direction to brighten the dark area of the image. Move the slider bar in the - direction to darken the dark area of the image.

Press **Reset** to return to the default settings.

#### NOTE!

The **Adaptive black stretch** setting may cause darker areas to become more noisy, and darker or brighter areas may be near the border between darker and brighter areas than other darker areas. If **Fog compensation** is set to **On**, this item cannot be set.

## Adaptive highlight stretch

Adjust the brightness of the bright area of the image.

Moving the slider bar in the + direction will increase the contrast between the light and dark areas of the image.

Move the slider bar in the - direction to reduce the contrast between the light and dark areas of the image.

Press **Reset** to return to the default settings.

#### NOTE!

If **Fog compensation** is set to **On**, this item cannot be set.

## Fog compensation

On/Off sets whether the fog correction function is enabled.

If **Intelligent Auto** is set to **On** or **Auto contrast adjust** is set to **On**, it cannot be set. With the fog correction function, digital image processing can be used to correct images easily when they are blurred, such as when a fog occurs.

On: Enables the fog correction function. Off: Stops the fog correction function.

#### NOTE!

When **Fog compensation** is set to **On**, **Contrast level**, **Adaptive black stretch**, and **Adaptive highlight stretch** cannot be set.

## Level

Adjust the fog correction level.

Moving the slider bar in the + direction increases the correction level, while moving the slider bar in the - direction decreases the correction level. Press **Reset** to return to the default settings.

## Pedestal level

Move the slider bar to adjust the black level of the image.



Moving the slider bar in the + direction brightens the image. Move the slider bar in the - direction to darken the image. Press **Reset** to return to the default settings.

## Scene registration

### Scene file

The combination of the set items can be saved as a scene file. Select the scene file here. You can set the saved scene file on the schedule page. If the shooting environment changes greatly depending on the time, you can record the image with a combination of settings appropriate to the environment by registering it in the schedule.

→[Using schedules, p. 345](#)

### Scene file title

You can change the scene file name (up to 10 characters) to be displayed in **Scene file**. Only the file names displayed in **1:**, **2:**, **3:**, **4:** can be changed.

Characters that cannot be entered: Half-pitch symbol " & ¥ **Load** buttons

The set data selected in **Scene file** is loaded and reflected in the current image. **Register** buttons

This feature registers combinations of currently displayed image quality-adjusted settings in a scene file displayed on the **Scene file**.

## Setting mask areas

This section explains how to adjust the light intensity by masking a portion of the screen. To configure the mask area, set **Super Dynamic** to **Off**.

Displays the image quality adjustment setting screen.

→[Configuring image quality, p. 187](#)

## Detailed settings

Configuring image and audio options for recordings

Cam. 1	Scene file is not applied
<b>+Basic adjustment</b>	
<b>+Super Dynamic(SD)</b>	<input type="radio"/> On <input checked="" type="radio"/> Off
<b>+Light control mode</b>	ELC
<b>+Day &amp; Night(IR)</b>	Auto1(Normal)
<b>+White balance</b>	ATW1 <input type="button" value="Set"/>
<b>+Intelligent Auto</b>	<input type="radio"/> On <input checked="" type="radio"/> Off
<b>+Detailed setting</b>	
<b>+Scene registration</b>	
*Any changes are updated immediately	
*Adjust the detail setting individually in the menu of each camera.	
<input type="button" value="Close"/>	

Click + to the left of the **Super Dynamic** to view the Detailed Super Dynamics menu.

<b>-Super Dynamic(SD)</b>	<input type="radio"/> On <input checked="" type="radio"/> Off
Level	<input type="button" value="-"/> <input type="button" value="Reset"/> <input type="button" value="+"/> 27
BLC/ HLC	Off
BLC level	<input type="button" value="-"/> <input type="button" value="Reset"/> <input type="button" value="+"/> 16
HLC level	<input type="button" value="-"/> <input type="button" value="Reset"/> <input type="button" value="+"/> 16
Mask area	<input type="button" value="Start"/> <input type="button" value="End"/> <input type="button" value="Reset"/>

Clicking on the **Start** buttons in the **Mask area** displays the boundaries and divides the images displayed on the **Image quality** tabs into 48 (8×6).

Image	Image quality	Audio
Image adjust		Setup >>
Privacy zone		Setup >>
VIQS		Setup >>

Click the split area to be masked to set the frame you clicked to the mask area and turn white. To release the mask, click the mask area again.

Image	Image quality	Audio
Image adjust		Setup >>
Privacy zone		Setup >>
VIQS		Setup >>

## Detailed settings

### Configuring image and audio options for recordings

---

Once the mask area has been set, clicking **Stop** will clear the frame from the images on the **Image quality** tab.

#### NOTE!

- If you change the **Image capture mode** of the **Image** tabs after you configure the mask area, the mask area may be misaligned. Be sure to check the mask area settings again.
- If you set EX optical zoom or HD EX optical zoom after setting the mask area, the mask area may be misaligned. Be sure to check the mask area settings again.

To cancel all mask areas, press **Reset**.

## Adjust the angle of view with the EX zoom

#### NOTE!

<Multisensor>: This function cannot be adjusted when **Image capture mode** is in Quad mode.

To Advanced Settings in **Extra zoom** on the **Image quality** tabs of video pages > >Click the **Button**. (**Image quality** for setting image quality adjustment, zoom/focus, privacy zone, VIQS, and lens distortion compensation)

→[Configuring image quality, p. 187](#)

Use EX Zoom to adjust the angle of view of the image.

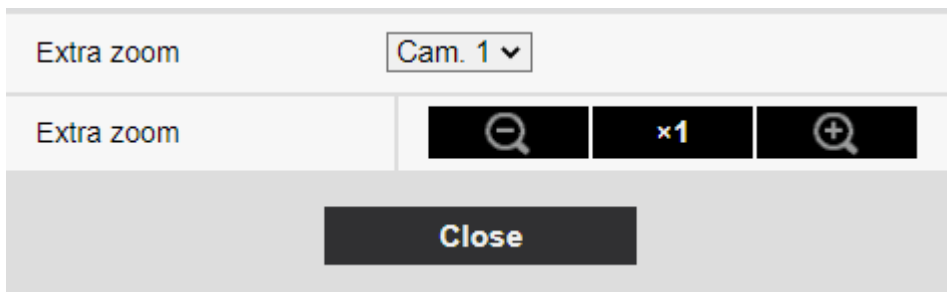

-: Zoom out of the image (increase **Wide angle**) by a zoom factor of 1.

x1: Show unzoomed image (zoom factor 1.0).

+: Zoom into the image (increase **Tele**) by a zoom factor of 1.

**NOTE!**

- The maximum magnification of the EX zoom depends on the model and the **Image capture mode** you are configuring.
- The extra zoom function may not be activated on the appropriate position if the setting for the function is performed after the settings for the VIQS area, privacy zone, VMD area, and SCD area. Therefore, configure each area's settings after configuring the extra zoom settings.
  - [Set up VIQS, p. 215](#)
  - [Setting the privacy zone \(Privacy zone setting screen\), p. 210](#)
  - [Configuring motion detection using VMD areas, p. 271](#)
  - [Configuring screen change detection using SCD areas, p. 281](#)
- Set the mask area to 1.0 times the zoom factor. After the EX zoom is set, the mask position is specified when the zoom (magnification) is 1.0 times.
  - [Setting mask areas, p. 201](#)

## Adjusting the zoom/focus

**NOTE!**

This function cannot be adjusted when **Image capture mode** is in dual-mode.

To **Advanced Settings** in **Zoom/Focus Adjustment** of the **Image quality** tabs on the video pages >  
>Click the **Button**. (**Image quality** for setting image quality adjustment, zoom/focus, privacy zone, VIQS, and lens distortion compensation)

→[Configuring image quality, p. 187](#)

Use Zoom and EX optical zoom to adjust the angle of view of the displayed image.

Adjust the focus by moving the lens focus to the optimal position. It can be adjusted manually or automatically.

**NOTE!**

<Multisensor>: The camera to adjust the angle of view can be selected.

## Detailed settings

### Configuring image and audio options for recordings

ImageImage/PrivacyAudio



Zoom/focus adjustment	Cam. 1 ▾								
Zoom ratio designation	<div style="display: flex; align-items: center;"><div style="flex-grow: 1;"><div style="width: 100%; height: 10px; background: linear-gradient(to right, red, yellow);"></div><div style="width: 100%; height: 10px; background-color: #ccc;"></div></div><div style="margin-left: 10px;">x1.1</div><div style="margin-left: 10px; background-color: black; color: white; padding: 2px 5px;">Execute</div></div>								
Manual zoom adjustment	<div style="display: flex; gap: 5px;"><div style="background-color: black; color: white; padding: 5px; border-radius: 5px;">⊖</div><div style="background-color: black; color: white; padding: 5px; border-radius: 5px;">1</div><div style="background-color: black; color: white; padding: 5px; border-radius: 5px;">⊕</div></div>								
Manual focus adjustment	<div style="display: flex; gap: 5px;"><div style="background-color: black; color: white; padding: 5px; border-radius: 5px;">Near</div><div style="background-color: black; color: white; padding: 5px; border-radius: 5px;">Reset</div><div style="background-color: black; color: white; padding: 5px; border-radius: 5px;">Far</div></div>								
Focus area setting	<div style="background-color: black; color: white; padding: 5px; border-radius: 5px;">Display</div>								
Auto focus	<div style="background-color: black; color: white; padding: 5px; border-radius: 5px;">Execute</div>								
Focusing at Day & Night switching	Auto ▾								
Grid display	<div style="display: flex; gap: 10px;"><div style="background-color: black; color: white; padding: 5px; border-radius: 5px;"><table border="1" style="font-size: 8px; border-collapse: collapse;"><tr><td>1</td><td>2</td><td>3</td><td>4</td></tr><tr><td>5</td><td>6</td><td>7</td><td>8</td></tr></table></div><div style="background-color: black; color: white; padding: 5px; border-radius: 5px;"></div></div>	1	2	3	4	5	6	7	8
1	2	3	4						
5	6	7	8						

Set

Close

### Zoom ratio designation

Adjust the zoom and focus simultaneously.



Press the slider bar to zoom in or out the angle adjustment frame in the image.

When you adjust the zoom (magnification) in the "telephoto" direction, only the image adjustment frame is reduced and you can specify the zoom (magnification) while checking the angle of view after the zoom is executed.

When the zoom (magnification) is adjusted in the "Wide angle" direction, the image itself is reduced or the frame for the zoom angle adjustment is enlarged. You can specify the zoom (magnification) while checking the image size after the zoom is executed.

Adjust the angle of view adjustment frame, and click **Execute** to zoom. Then, automatically adjust the focus to the object in the center of the window using the auto focus function.

**NOTE!**

- The maximum magnification of the EX zoom depends on the model and the **Image capture mode** you are configuring.
-  In the **Manual zoom adjustment**  Buttons, When you press buttons, **Zoom ratio designation** cannot be operated. To perform **Zoom ratio designation**, click the "Read" button or click the X1 button on the **Manual zoom adjustment**.
- When EX optical zoom is set with the VIQS area, privacy zone, operation detection area, screen change detection area, and mask area set, the position is misaligned. Therefore, set the EX optical zoom and then set each area.
  - Set up VIQS, p. 215
  - Setting the privacy zone (Privacy zone setting screen), p. 210
  - Configuring motion detection using VMD areas, p. 271
  - Configuring screen change detection using SCD areas, p. 281
  - Setting mask areas, p. 201

**Manual zoom adjustment**

Adjust the zoom manually.

: Zoom out of the image (increase **Wide angle**) by a zoom factor of 1.

: Show unzoomed image (zoom factor 1.0).

: Zoom into the image (increase **Tele**) by a zoom factor of 1.

**Manual focus adjustment**

Adjust the focus manually.

- **Near**: Adjust the focus to the **Near**.
- **Reset** returns focus (focus) to its default settings. **Far**: Adjust the focus to the **Far**.

**NOTE!**

One-click on the **Near** or **Far** buttons may appear to have no change in focus due to trace adjustments. If you want to move the focus position large, press and hold the button for a long time.

**Focus area setting**

When auto focus is executed, you can specify the object in the frame where you want to adjust the focus.

## Detailed settings

### Configuring image and audio options for recordings

---

If not, adjust the focus to the object in the center area of the window.

**Display:** Displays the auto focus frame on the setup window. The default setting is displayed in the center area of the screen. Drag the mouse on the image and specify the area where you want to adjust the focus. When you are finished, press **Register**.

When the **Display** button is clicked, the **Reset** and **Register** buttons are displayed. **Reset:** Returns the frame setting to the default position.

**Register:** Saves the set frame. Clicking to automatically adjust focus to the object in the specified area.

#### **NOTE!**

If you set the focus frame and then change the "Rotate images" on the **Basic** tab or "Image capture mode" on the **Image** tab, the focus frame may be misaligned. Be sure to check the focus frame settings again.

## Auto focus

When **Execute** is clicked, the auto focus function is activated to automatically adjust the focus to the object in the center of the window.



**NOTE!**

- If the **Image capture mode** is **Single source [4:3(30fps mode)]**, it may take a lot of time for auto focus to be completed if auto focus is executed while the slow shutter is running at night while **Maximum shutter** is set to longer than **1/30s**.
- If the **Image capture mode** is **Single source [4:3(25fps mode)]**, it may take a lot of time for auto focus to be completed if auto focus is executed while the slow shutter is running at night while **Maximum shutter** is set to longer than **1/25s max.**
- The focus may not be adjusted automatically in the following locations or object. In this case, adjust the focus manually.
  - Large areas is the image are changing
  - Large variation in illumination Low illuminance
  - Be too bright or too reflective
  - Over the window
  - Dome covers are prone to contamination.
  - White walls are less dark.
  - Flicker fiercely
- When the image is switched from color to black and white in the near infrared region, the focus may shift due to the optical characteristics. If **Focusing at Day & Night switching** is set to **Auto** or **Preset**, the camera can focus automatically (it does not support the lighting change after the focus operation is completed).

**Focusing at Day & Night switching**

Select the focus adjustment method when switching between color image and black-and-white image from the following.

- **Auto:** The focus is automatically adjusted when the color/black-and-white settings are changed from the focus-adjusted image. When the original color/black/white status is changed, the focus position is returned to the last one. If the image cannot be adjusted with a black-and-white image, the image may be re-adjusted with a color image and then switched to a black-and-white image.
- **Preset:** When switching between color image and black-and-white image, the preset is moved to the specified focus position. In the preset position, the color image or black-and-white image automatically stores the focus position set last.
- **Fix:** After adjusting the focus automatically or manually, fix the position.

**NOTE!** If the focus cannot be adjusted automatically when switching between color and black and white images in the **Auto** setting, set it to **Preset** or **Fix** and adjust the focus manually.

#### Grid display

You can switch on/off the grid view that can be used to adjust the position of the machine when using Extension software. For adjusted sizes for each Extension software, our Technical Information website<Control No.: C0320 > Please refer to.

#### Close button

Close the Zoom/Focus dialog box.

### Setting the privacy zone (Privacy zone setting screen)

In the Video/Audio **Image quality** tabs to **Privacy zone** Advanced Settings > >Click the **Button**.

→[Configuring image quality, p. 187](#)

If there are areas in the shooting location (image) that you do not want to display, do not display those areas as privacy zones.

#### **NOTE!**

The maximum number of privacy zones depends on the camera model.<PTZ>: The Privacy Zone function does not work during initial operation or position refresh immediately after the power supply is turned on.

<PTZ>: Depending on the orientation of the camera (especially the tilt angle of 45° to 90°) or the magnification factor, you may see where you want to hide. Be sure to check after setting.

<PTZ>: Reset the Privacy Zone when you change the method of fixing the camera.

The privacy zone function of each camera is described below.

## PTZ camera

Image
Image quality
Audio



Privacy zone  On  Off **Set**

Zone select Zone No  **Set** **Delete** **Cancel**

Privacy zone:Min. Zoom  On  Off

\* When shifting to a lower zoom factor than the set zoom factor, the privacy zone will not be displayed.

Zoom

⏪
🔍
⏩



Brightness

-
Normal
+

Focus

Auto
Near
Far

Preset

1:

▼

**Go**

**Close**

### Privacy zone

Select the display format of the privacy zone from the following.

- **On:** Display in gray
- **Off:** Not displayed.

### Zone select

Click ▼ on the **Zone No** and select the number of zones you want to set.

The \* mark to the right of the zone number indicates that a privacy zone has already been set.

When you drag the desired range with the mouse, it is set as the privacy zone.

Once the position has been determined, press **Set**.

## Detailed settings

### Configuring image and audio options for recordings

---

To delete a registered zone, specify the zone number and press **Delete**. To cancel setting or deletion, press **Cancel**.

#### NOTE!

- The privacy zone should be set broadly for objects that you want to hide.
- It is recommended to set the zone between 1 and 3 times the zoom magnification to increase the zone accuracy on the wide angle side.

#### Privacy zone: Min. Zoom

Use **On** or **Off** to toggle the smallest zoom in zones.

- **On**: The current zoom position is saved.
- **Disable**: The zoom position is saved as X1 times. The privacy zone is always displayed regardless of the zoom position.

#### NOTE!

If enabled, the privacy zone will not be displayed if you move to a magnification lower than the set zoom magnification.

#### Zoom buttons



: Zoom out of the image (increase **Wide angle**) by a zoom factor of 1.



: Show unzoomed image (zoom factor 1.0).



: Zoom into the image (increase **Tele**) by a zoom factor of 1.

#### Focus buttons

- **Auto**: Automatically adjust focus.
- **Near**: Adjust the focus (focus) to **Near**.
- **Far**: Adjust the focus (focus) to **Far**.

#### Control pad/button

Left-click the pads and buttons to adjust the horizontal and vertical position of the image (pan tilt).

The faster the camera operates, the faster the outside of the pad is clicked. You can also drag and adjust the mouse. Zoom and focus by right-clicking.

Clicking on the upper half of the pad in the upper and lower directions will zoom in the telephoto, and clicking on the lower half will zoom in the wide angle. Clicking on the left half in the left and right directions will bring the focus (focus) close to you, and clicking on the right half will bring it far away. You can also adjust the zoom by using the mouse wheel.

**Brightness buttons**

It can be adjusted from 0 to 255. Click the **Light (+)** button to brighten the image. Click the **Black (-)** button to darken the image. Press **Normal** to return to the default settings.

**Move button**

Select the preset position from the pull-down menu and click the **Move** button to move the camera's orientation to the preset position registered beforehand. **H** next to the number indicates the home position. Select **HomePosition** to move the orientation of the camera to the home position.

→[Setting preset positions, p. 234](#)

→[Configuring PTZ camera functions, p. 227](#)

If **Preset ID (0 – 9,A – Z)** is registered, the position name is displayed next to the number.

**Close** button: Closes the Privacy Zone Settings window.

## Multisensor camera

Image
Image quality



Area can be set by designating 4 points on the screen.

Privacy zone	Cam. 1 ▾			
Area	1(White) <input type="checkbox"/>	2(Blue) <input checked="" type="checkbox"/>	3(Green) <input checked="" type="checkbox"/>	4(Red) <input checked="" type="checkbox"/>
Status	<input type="radio"/> On <input checked="" type="radio"/> Off	<input type="radio"/> On <input checked="" type="radio"/> Off	<input type="radio"/> On <input checked="" type="radio"/> Off	<input type="radio"/> On <input checked="" type="radio"/> Off
Delete	<b>Delete</b>	<b>Delete</b>	<b>Delete</b>	<b>Delete</b>
Area	5(Yellow) <input type="checkbox"/>	6(Light blue) <input type="checkbox"/>	7(Purple) <input type="checkbox"/>	8(Pink) <input type="checkbox"/>
Status	<input type="radio"/> On <input checked="" type="radio"/> Off	<input type="radio"/> On <input checked="" type="radio"/> Off	<input type="radio"/> On <input checked="" type="radio"/> Off	<input type="radio"/> On <input checked="" type="radio"/> Off
Delete	<b>Delete</b>	<b>Delete</b>	<b>Delete</b>	<b>Delete</b>

Set
Close

### Camera selection

Select the camera to set the privacy zone from each camera.

**NOTE!**

When **Image capture mode** is in Quad mode, the camera cannot be selected.

### Area

This is set as the privacy zone by specifying four vertices on the image. Each zone can also be set in overlap. The zones are set in order from Area 1.

**NOTE!**

- The privacy zone should be wider than the hidden object.
- If **Image capture mode** is in Quad mode, you cannot specify any four points across the cameras in the area.

**Status**

Use **On/Off** to set whether the privacy zone is displayed.

**On:** Displays the privacy zone.

**Off:** Privacy zone is not displayed.

**Delete button**

Click the button on the area to delete the button to delete the zone.

**Close button**

Close the Privacy Zone Settings window.

**NOTE!**

- If you configure a privacy zone and then change the **Image capture mode** and **Basic** tab **Image rotation** on the **Image** tab, the privacy zone may be misaligned. Be sure to check the privacy zone settings again.
- Setting the privacy zone and then setting the EX zoom may cause the privacy zone to be misaligned. Be sure to check the privacy zone settings again.
- If the privacy zone is set when lens distortion compensation is enabled, it may be misaligned. In such a case, return the lens distortion compensation to **0** and set the privacy zone. Then, set the lens distortion compensation again.

## Set up VIQS

To Advanced Settings on the **Image quality** tabs of Video/Audio pages **VIQS** > >Click the **Button**.

→[Configuring image quality, p. 187](#)

### What is VIQS?

Abbreviation for *Variable Image Quality on Specified Area*. This function enables you to change the image quality in the specified area.

Image quality in the range specified in the shooting location (image) can be made high quality for easy viewing. Image quality outside the specified range is low and image data size can be suppressed.

## Detailed settings

### Configuring image and audio options for recordings

#### NOTE!

- VIQS covers only H.265 (or H.264) images.
- Up to eight VIQS areas can be set.
- After **Stream** is set to **On**, press **Execute** to view the images after VIQS is set.
- You can also view the H.265 (or H.264) image on a live image page.
- The VIQS function cannot be used in the following cases.
  - -When **Stream(1)Smart VIQS** is set to **On(High)** or **On(Low)** When-**Smart P-picture control** is set to **On**

## PTZ camera

Select the position for which you want to set the VIQS area and press **Start** to open the VIQS area setting window for the selected position.

You can specify the VIQS area on the displayed setting screen.

## VIQS area setting

Image	Image quality	Audio
		
VIQS Area		
Select a preset position		except the preset positions <input type="button" value="Start"/>
<input type="button" value="Close"/>		



**Select a preset position**

Select the preset position number for which you want to configure the VIQS area, and then press **Start** to configure the VIQS area.

Select **except the preset positions** to set the VIQS area other than the preset position.

**Close button**

Click to close the VIQS Settings window.

## Detailed settings

### Configuring image and audio options for recordings

ImageImage qualityAudio



except the preset positions VIQS Area Center

Area	1(White) <span style="display: inline-block; width: 15px; height: 15px; border: 1px solid black; background-color: white;"></span>	2(Blue) <span style="display: inline-block; width: 15px; height: 15px; background-color: blue;"></span>	3(Green) <span style="display: inline-block; width: 15px; height: 15px; background-color: green;"></span>	4(Red) <span style="display: inline-block; width: 15px; height: 15px; background-color: red;"></span>
Status	<input type="radio"/> On <input checked="" type="radio"/> Off	<input type="radio"/> On <input checked="" type="radio"/> Off	<input type="radio"/> On <input checked="" type="radio"/> Off	<input type="radio"/> On <input checked="" type="radio"/> Off
Delete	<span style="background-color: black; color: white; padding: 2px 5px;">Delete</span>	<span style="background-color: black; color: white; padding: 2px 5px;">Delete</span>	<span style="background-color: black; color: white; padding: 2px 5px;">Delete</span>	<span style="background-color: black; color: white; padding: 2px 5px;">Delete</span>
Area	5(Yellow) <span style="display: inline-block; width: 15px; height: 15px; background-color: yellow;"></span>	6(Light blue) <span style="display: inline-block; width: 15px; height: 15px; background-color: cyan;"></span>	7(Purple) <span style="display: inline-block; width: 15px; height: 15px; background-color: purple;"></span>	8(Pink) <span style="display: inline-block; width: 15px; height: 15px; background-color: magenta;"></span>
Status	<input type="radio"/> On <input checked="" type="radio"/> Off	<input type="radio"/> On <input checked="" type="radio"/> Off	<input type="radio"/> On <input checked="" type="radio"/> Off	<input type="radio"/> On <input checked="" type="radio"/> Off
Delete	<span style="background-color: black; color: white; padding: 2px 5px;">Delete</span>	<span style="background-color: black; color: white; padding: 2px 5px;">Delete</span>	<span style="background-color: black; color: white; padding: 2px 5px;">Delete</span>	<span style="background-color: black; color: white; padding: 2px 5px;">Delete</span>
Level	<span style="border: 1px solid #ccc; padding: 2px 5px;">5 Normal</span>			
Stream				
Stream(1)	<input type="radio"/> On	<input checked="" type="radio"/> Off	<span style="background-color: black; color: white; padding: 2px 5px;">Confirm</span>	
Stream(2)	<input type="radio"/> On	<input checked="" type="radio"/> Off	<span style="background-color: black; color: white; padding: 2px 5px;">Confirm</span>	
Stream(3)	<input type="radio"/> On	<input checked="" type="radio"/> Off	<span style="background-color: black; color: white; padding: 2px 5px;">Confirm</span>	
Stream(4)	<input type="radio"/> On	<input checked="" type="radio"/> Off	<span style="background-color: black; color: white; padding: 2px 5px;">Confirm</span>	

Variable Image Quality on Specified area (VIQS) allows the designated area to retain higher image quality. The excluded area will have a decreased image quality, allowing for a lower image file size/bit rate to be used. To check the area to where VIQS is applied, push the confirm button after setting areas.

SetBack

#### Area

When the VIQS area is selected in the image, it is set from Area 1.

#### Center button

When clicked, the center is selected as the VIQS area and set to the **1(White)** of the **Area. Status**

Set the VIQS area with **On** and **Off**.

**On:** Set the VIQS area.

**Off:** Do not configure the VIQS area.

### Delete button

Click the area button to delete the area frame.

### Level

Sets the level difference between the quality in the specified range and the quality outside the specified range. The larger the level difference, the lower the image quality outside the specified range and the smaller the image data size. **0: Minimum/1/2/3/4/5: standard/6/7/8/9: maximum**

### Stream selection

Use **On/Off** to specify whether the VIQS function is enabled for images delivered to streams. The **Execute** button allow you to view images of individual streams.

#### NOTE!

- If you set the VIQS setting to **On** and then change the **Image capture mode** and **Basic** tab **Image rotation** on the **Image** tab of the video and audio pages, the VIQS area may be misaligned. Be sure to reconfirm the VIQS settings.
- Refer to the following procedure for setting the VIQS area.  
→[Defining VIQS areas, p. 221](#)
- If the **Stream transmission** of the relevant stream is set to **Off**, you cannot press the **Execute** button for selecting the stream.

## Detailed settings

### Configuring image and audio options for recordings

## Multisensor camera

Image      **Image quality**



Cam. 1 ▾

Area	1(White) <input type="checkbox"/>	2(Blue) <input type="checkbox"/>	3(Green) <input type="checkbox"/>	4(Red) <input type="checkbox"/>
Status	<input type="radio"/> On <input checked="" type="radio"/> Off	<input type="radio"/> On <input checked="" type="radio"/> Off	<input type="radio"/> On <input checked="" type="radio"/> Off	<input type="radio"/> On <input checked="" type="radio"/> Off
Delete	<b>Delete</b>	<b>Delete</b>	<b>Delete</b>	<b>Delete</b>
Area	5(Yellow) <input type="checkbox"/>	6(Light blue) <input type="checkbox"/>	7(Purple) <input type="checkbox"/>	8(Pink) <input type="checkbox"/>
Status	<input type="radio"/> On <input checked="" type="radio"/> Off	<input type="radio"/> On <input checked="" type="radio"/> Off	<input type="radio"/> On <input checked="" type="radio"/> Off	<input type="radio"/> On <input checked="" type="radio"/> Off
Delete	<b>Delete</b>	<b>Delete</b>	<b>Delete</b>	<b>Delete</b>
Level	5 Normal ▾			
Stream				
Stream(1)	<input type="radio"/> On <input checked="" type="radio"/> Off	<b>Confirm</b>		
Stream(2)	<input type="radio"/> On <input checked="" type="radio"/> Off	<b>Confirm</b>		

Variable Image Quality on Specified area (VIQS) allows the designated area to retain higher image quality. The excluded area will have a decreased image quality, allowing for a lower image file size/bit rate to be used. To check the area to where VIQS is applied, push the confirm button after setting areas.

**Set**      **Close**

## Camera selection

Select the camera to set the VIQS area from each camera.

**NOTE!**

When **Image capture mode** is in Quad mode, the camera cannot be selected.

**Area**

When the VIQS area is selected in the image, it is set from Area 1. **Status**

Set the VIQS area with **On** and **Off**.

- **On:** Set the VIQS area.
- **Off:** Do not configure the VIQS area.

**Delete**

Click the button of the area to delete to delete the area frame.

**Level**

Sets the level difference between the quality in the specified range and the quality outside the specified range. The larger the level difference, the lower the image quality outside the specified range and the smaller the image data size.

0: Minimum/1/2/3/4/5: standard/6/7/8/9: maximum

**Stream selection**

Use **On/Off** to specify whether the VIQS function is enabled for images delivered to streams. The **Execute** button allow you to view images of individual streams.

**NOTE!**

- If you turn on the VIQS setting and then change the **Image capture mode** and **Basic** tab **Image rotation** on the **Image** tab of the video and audio pages, the VIQS area may be misaligned. Be sure to check the VIQS settings again.
- Refer to the following procedure for setting the VIQS area.  
→[Defining VIQS areas, p. 221](#)
- If the **Stream transmission** of the relevant stream is set to **Off**, you cannot press the **Execute** button for selecting the stream.

**Defining VIQS areas**

Set the VIQS area as follows.

## Detailed settings

### Configuring image and audio options for recordings

1. Drag the mouse on the image and specify the area. You can specify up to 8 areas. The specified location is set to Area **1(White)**, and a frame is displayed.  
Areas are set from the first to the first area number. The color next to the area number indicates the corresponding color of the frame.

Image      **Image quality**



Cam. 1 ▾

Area	1(White) <input type="checkbox"/>	2(Blue) <input checked="" type="checkbox"/>	3(Green) <input type="checkbox"/>	4(Red) <input type="checkbox"/>
Status	<input checked="" type="radio"/> On <input type="radio"/> Off	<input checked="" type="radio"/> On <input type="radio"/> Off	<input type="radio"/> On <input checked="" type="radio"/> Off	<input type="radio"/> On <input checked="" type="radio"/> Off
Delete	<input type="button" value="Delete"/>	<input type="button" value="Delete"/>	<input type="button" value="Delete"/>	<input type="button" value="Delete"/>
Area	5(Yellow) <input type="checkbox"/>	6(Light blue) <input type="checkbox"/>	7(Purple) <input type="checkbox"/>	8(Pink) <input type="checkbox"/>
Status	<input type="radio"/> On <input checked="" type="radio"/> Off	<input type="radio"/> On <input checked="" type="radio"/> Off	<input type="radio"/> On <input checked="" type="radio"/> Off	<input type="radio"/> On <input checked="" type="radio"/> Off
Delete	<input type="button" value="Delete"/>	<input type="button" value="Delete"/>	<input type="button" value="Delete"/>	<input type="button" value="Delete"/>
Level	5 Normal ▾			
Stream				
Stream(1)	<input type="radio"/> On	<input checked="" type="radio"/> Off	<input type="button" value="Confirm"/>	
Stream(2)	<input type="radio"/> On	<input checked="" type="radio"/> Off	<input type="button" value="Confirm"/>	

Variable Image Quality on Specified area (VIQS) allows the designated area to retain higher image quality. The excluded area will have a decreased image quality, allowing for a lower image file size/bit rate to be used. To check the area to where VIQS is applied, push the confirm button after setting areas.

2. Set the level difference between the quality in the specified range and the quality outside the specified range. The larger the level difference, the lower the image quality outside the specified range and the smaller the image data size.
3. On/Off selects whether to enable the VIQS function on the delivered image of each stream.
4. Press **Set**. The settings are reflected on the camera. To delete the setting area, click **Delete** in the area to delete.
5. Press **Execute**. The streams with the **Execute** buttons are displayed. The current output bit rate can be checked when another window opens for approximately 3 seconds.

**NOTE!**

- If you do not press **Set**, the settings will not be confirmed.
- Visual image after VIQS setting can be confirmed by displaying the H.265 (or H.264) image on the live image page or by pressing **Execute** on the **Stream**.
- The current output bit rate varies depending on the subject. Check the actual subject during operation.
- The larger the specified range, the larger the output bit rate. Check the current output bit rate and determine the size of the area.

## Set the lens distortion compensation

To Advanced Settings on the **Image quality** tabs of Video/Audio pages **Lens distortion compensation** > >Click the **Button**.

→[Configuring image quality, p. 187](#)

You can use lens distortion correction to correct the distortion. The correction amount can be adjusted.

The degree of distortion compensation depends on the zoom factor. Adjust the image angle with the zoom setting and then set the lens distortion compensation.

### Camera selection

Select the camera to adjust the lens distortion compensation from each camera.

**NOTE!**

- <Multisensor>: **Camera selection** can be selected only for Multisensor cameras.
- <Multisensor>: When **Image capture mode** is in Quad mode, the camera cannot be selected.

### Lens distortion compensation

You can switch the lens distortion compensation ON/OFF.

## Detailed settings

### Configuring image and audio options for recordings

---

Move the slider bar in the + direction or - direction to adjust the image distortion.

Press **Reset** to return to the default settings.

#### NOTE!

- When EX optical zoom is used, lens distortion compensation does not work.
- When lens distortion compensation is set to ON, all cameras are set to ON. Turning on lens distortion compensation may lower the frame rate.

## Configuring audio options

Click on the **Audio** tabs of the video and audio pages. Refer to the following how to display and operate the **Detailed settings** menu.

→[Accessing the camera settings menu, p. 109](#)

→[Editing the camera settings, p. 111](#)

#### NOTE!

- Images and sound are not synchronized. Therefore, there may be a slight deviation between the image and sound.
- Depending on the network environment, audio may be interrupted.

## Voice input

### Mic input volume

Set the volume of sound input to the camera. This setting is reflected in the volume of sound (listening) on the camera and the volume at **Audio recording**.

**Mic strength/Mic in progress/Microphone weak:** Set the volume when the sound is entered into the camera by microphone.

**Line Strength/In Line/Line Weak:** Set the volume when the sound is inputted to the camera line.

### AGC (audio)

The earpiece sound is automatically amplified and adjusted to the appropriate volume. Select the degree of amplification from High/Middle/Low. When set to **High**, it is easier to hear a small sound, but it may be heard as a noise. If you are concerned about noise, set it to **Middle** or **Low**. This setting is linked to the **Audio recording** volume.

### Max bit rate

Set the bit rate of sound compression. **G.726:** 16kbps/ 32kbps



**G.711:** 64 kbps (cannot be changed)

**AAC-LC:** 64kbps/ 96kbps/ 128kbps Voice delivery

### Audio transmission mode

Set the communication mode for sending/receiving voice data between the camera and PC from the following.

- **Off:** Audio data is not transmitted or received between the camera and the PC.
- **Mic input:** The PC receives audio data from the camera. You can hear sound together with images on a PC. Images and sound are not synchronized.
- **Audio output:** The audio data from the PC is transmitted to the camera. Audio can be played through a speaker connected to the camera.
- **Interactive(Half-duplex):** You can make both listening and outgoing calls. However, audio cannot be sent/received simultaneously.
- **Interactive(Full-duplex):** You can both listen and talk at the same time.

#### NOTE!

- The howling may occur depending on the operating conditions. In this case, do not allow the sound output from the PC to enter the microphone of the PC.
- **Audio recording** cannot be used when **Audio transmission mode** is set to **Interactive (Half-duplex)**.
- When using live picture pages, use HTTPS to access live picture pages.

### Mic input interval (Camera to PC)

Select the voice reception interval from the following. **20ms/ 40ms/ 80ms/ 160ms**

#### NOTE!

- The shorter the call interval, the shorter the delay time. Increasing the value lengthens the delay time but reduces speech interruption. Change the settings depending on your network environment.
- If **AAC-LC** is selected in **Audio input encoding format**, **Mic input interval (Camera to PC)** cannot be selected.

### Audio output volume (PC to Camera)

Sets the volume to which the sound from the PC is played from the camera. **High/Middle/Low**

### Audio output interval (PC to Camera)

Select the voice transmission interval from the following. **160ms/ 320ms/ 640ms/ 1280ms**

## Detailed settings

### Configuring image and audio options for recordings

---

#### NOTE!

- The smaller the call interval, the shorter the delay time. Increasing the value lengthens the delay time but reduces speech interruption. Change the settings depending on your network environment, the performance of your PC, and the usage status of applications other than web browsers.
- When multiple users are accessing the camera, the sound may be temporarily interrupted or the noise may be output. Increasing the transmission interval can reduce speech interruptions and noise.
- Sound may not be output depending on your network environment and settings.

### Audio output duration

You set the maximum time for one call.

#### NOTE!

The call stops after the set time after the start of the call. If you want to make another call, click the call button.

### Audio output port (PC to Camera)

Enter the destination port number (the port number on the camera to receive audio input). Configurable port number: 1024 to 50000 (even number only)

#### NOTE!

The Destination port number entered in **Audio output port (PC to Camera)** is used only if **Transmission type** is set to **Unicast port (MANUAL)**. If **Stream transmission** has selected **Off** or **Transmission type Unicast port (AUTO)** or **Multicast**, you do not need to enter the Destination port number.

## Live image pages

### Audio input encoding format

Select the compression method of earpiece voice from G.726/G.711/AAC-LC.

#### NOTE!

- Only AAC-LC can be accessed from a Web browser.
- G.711 can be selected only when **Audio transmission mode** is **Mic input**.
- G.726 is always applied to the compression method for voice transmission.

## Audio volume control mode

Select how to use the volume cursor of the earpiece button on the live picture page.

- **Adjust the PC volume:** You change the volume of the PC that is opening the Live Picture page.
- **Manipulate camera audio input volume:** You change the earpiece volume of the camera.

# Setting the PTZ options

The PTZ page is used to set the camera operation, preset position, and auto tracking.

The PTZ pages consist of the **Cam. Function**, **Position**, **Auto track setting**, and **Auto track alarm setting** tabs.

## Configuring PTZ camera functions

Click on the **Cam. Function** tab of the PTZ page. Refer to the following how to display and operate the **Detailed settings** menu.

→[Accessing the camera settings menu, p. 109](#)

→[Editing the camera settings, p. 111](#)

This section sets the operation of the camera.

## Detailed settings

### Setting the PTZ options

Cam. Function	Position	Auto track	Auto track alarm setting
Basic settings			
Home position	Off ▾		
Self return	Off ▾		
Self return time	1min ▾		
Maximum optical zoom ratio	Unlimited ▾		
HD Extra optical zoom	<input checked="" type="radio"/> On <input type="radio"/> Off		
Digital zoom	<input type="radio"/> On <input checked="" type="radio"/> Off		
Camera position display	Pan-Tilt degree/Zoom ratio display ▾		
Operation mode display	<input type="radio"/> On <input checked="" type="radio"/> Off		
Tilt Angle	0° ▾		
<b>Set</b>			
Advanced setting			
Maximum optical zoom speed	High ▾		
Maximum panning/tilting speed	Unlimited ▾		
Pan/Tilt Operability	Profile1(Normal) ▾		
Focus distance	Unlimited ▾		
<b>Set</b>			

## Home position

You can set the preset position as the home position.

When the home position is set, **H** is displayed next to the preset position number.

→[Setting preset positions, p. 234](#)

### NOTE!

If you want to move to the home position when the power is turned on, set **HomePosition** to **Self return**.

## Self return

When the time set by **Self return time** has elapsed after manual operation, the camera can automatically return to one of the following modes of operation.

- **Off:** Do not perform self-return.
- **Home position:** After the set time has elapsed, the camera returns to the home position.
- **Auto Pan:** When the set time elapses, the auto pan operation starts.
- **Preset Sequence 1:** When the set time elapses, Sequence 1 operation starts.
- **Preset Sequence 2:** Sequence 2 operation starts when the set time elapses.
- **Preset Sequence 3:** Sequence 3 operation starts when the set time elapses.
- **Patrol:** When the set time elapses, the patrol operation starts.

### NOTE!

- If you want to perform the above operations when turning on the power, it is convenient to use the self-turn function.  
The Self-turn function works even when the Setup menu is displayed.
- **Patrol** can be set only when patrols are set.  
→[Configuring patrol patterns, p. 243](#)
- **Preset sequence** can be set only when the preset sequence is set.  
→[Setting preset sequences, p. 239](#)

## Self return time

After the manual operation is completed, select the time from the following to return to the operation set by **Self return**.

## Upside-down

Use **On** or **Off** to set whether to flip the images up or down.

- **On:** The image is inverted upside down.
- **Off:** The image is not flipped up or down.

## HD Extra optical zoom

Select the setting of HD EX optical zoom from the following.

## Detailed settings

### Setting the PTZ options

---

- **On:** 1-fold to 21-fold optics and more (up to 31-fold) HD EX optics zoom.
- **Off:** HD EX optical zoom is not performed. It is within the optical zoom range.

### What is HD EX optical zoom?

Of the effective pixels of the MOS sensor, approximately 920,000 pixels (equivalent to 1280 x 720 resolution) are cut off from the center and shot. Therefore, using a resolution of less than 1280 x 720 makes it possible to shoot with a higher telephoto effect.

## Digital zoom

Select the digital zoom setting from the following.

- **On:** Use the optical zoom to 1 to 21 times, the HD EX optical zoom to 31 times, and the digital zoom to 336 times.
- **Off:** Digital zoom is not performed.

#### NOTE!

- When **On** is set to Digital Zoom, it stops once just before the Digital Zoom magnification changes during the zoom operation.
- The preset position cannot be set with the digital zoom factor.
- If **HD Extra optical zoom** is **Off**, **Digital zoom** cannot be set to **On**.

## Camera position display

Select the information displayed in the image during manual operation from the following. **Off:** The information is not displayed in the image.

**Pan tilt angle/magnification display:** Displays pan angle/tilt angle/magnification. **Directional view:** Displays the direction.

**NOTE!**

- When set to **Pan Tilt degree/Zoom ratio display**, the pan tilt angles/magnifications are displayed in the **Camera title position** set on the Basic Page **Basic** tab.  
→[Setting a pan/tilt range, p. 247](#)
- When set to **Direction display**, the orientation is displayed in the **Camera title position** you set on the **Basic** tab of the basic page.  
→[Configuring directions and angles, p. 245](#)
- To select **Direction display**, set the reference northern direction with the **Direction/Angle settingNorth point setting**.  
→[Configuring directions and angles, p. 245](#)

## Operation mode display

Displays the operation mode when the camera is running automatically.

- **On:** Displays the operating mode.
- **Off:** The operation mode is not displayed.

Operation mode	Display
During startup	INITIAL
During auto pan	AUTO PAN
Automatic tracking (in progress)	AUTO TRACKING
During patrol	PATROL
During the preset sequence	PRESET SEQ

## Pan/tilt-flip

Select the pan/tilt flip setting from the following.

- **On:** When the pan end point and the tilt end point (directly below) are reached during manual operation, the pan can be automatically rotated at high speed to continue operation without stopping at the pan end point and the tilt end point.
- **Off:** The pan/tilt flip function does not work.

#### NOTE!

- On the TELE side, some parts are not visible even when the pan/tilt flip function is activated.
- In the main area of the live image page, clicking the desired position for the center of the field angle moves the camera's orientation to the center of the clicked position. In this case, the operation continues without stopping at the pan tilt end point.
- During flip movement, the image being moved is displayed.

## Tilt Angle

Select the angle limit of tilt operation.

#### NOTE!

The screen may be partially darkened if it is directed above-20 degrees.

## Maximum optical zoom factor

Select the maximum zoom factor for the optical zoom.

## Maximum optical zoom speed

Select the maximum speed of the optical zoom.

## Maximum panning/tilting speed

Select the maximum speed for pan tilt operation.

## Focus distance

If you are viewing a subject through a glass or if you have another subject in the short distance, it may be difficult to focus on the subject you want to view. If the camera is not focused properly, you can limit the shortest shooting distance.

## Setting PTZ positions

Click on the **Position** tab of the PTZ page. Refer to the following how to display and operate the **Detailed settings** menu.

→[Accessing the camera settings menu, p. 109](#)

→[Editing the camera settings, p. 111](#)



To Advanced Settings for each item >>Clicking this button displays the **Detailed settings** menus window in a separate window and allows you to set the settings while viewing the images displayed on the **Position** tab.

## The Position tab

Here, you can set the image quality adjustment, preset position, preset sequence setting, auto pan, patrol, direction/direction setting, and pan/tilt range setting.

Cam. Function    **Position**    Auto track    Auto track alarm setting



Preset position		Setup >>
Preset sequence setting		Setup >>
Auto pan		Setup >>
Patrol		Setup >>
Direction/Angle		Setup >>
Pan/tilt range setting		Setup >>

### Preset position

To Advanced Settings >>When the button is clicked, the preset position setting window is displayed in a separate window.

→[Setting preset positions, p. 234](#)

### Preset sequence setting

To Advanced Settings >>When the **button** is clicked, the preset sequence settings window is displayed in a separate window.

→[Setting preset sequences, p. 239](#)

#### Auto pan

To Advanced Settings > >Click the **Auto Pan** button to display the auto pan setting window in a separate window.

→[Configuring auto pan, p. 241](#)

#### Patrol

To Advanced Settings > >When the **Patrol** button is clicked, the setting window for the patrol is displayed in another window.

→[Configuring patrol patterns, p. 243](#)

#### Direction/Angle

To Advanced Settings > >When the button is clicked, the setting window for direction/direction setting is displayed in a separate window.

→[Configuring directions and angles, p. 245](#)

#### Pan/tilt range setting

To Advanced Settings > >Click the **Button** button to open a window for specifying the pan/tilt range.

→[Setting a pan/tilt range, p. 247](#)

### Setting preset positions

In the **Position** tab of the PTZ-page to the Advanced Settings tab of **Preset position** > >Click the **Button**.

→[Setting PTZ positions, p. 232](#)

Here, you can register, change, or delete the preset position.

If you adjust the focus, brightness, zoom, etc., the images on the **Position** tabs will be reflected at the same time.

Preset No.	<input type="text"/>																		
Position No.																			
Preset ID	<input type="radio"/> On <input type="radio"/> Off																		
Preset ID (0 – 9,A – Z)	<input type="text"/>																		
Auto focus	<input type="radio"/> Auto <input type="radio"/> Off																		
Dwell time	<input type="text"/>																		
<input type="button" value="Set"/> <input type="button" value="Delete"/>																			
*Any changes are updated immediately																			
Super Dynamic	<input type="radio"/> On <input type="radio"/> Off																		
Level	<input type="range"/> <input type="button" value="Reset"/>																		
BLC/ HLC	<input type="text"/>																		
BLC level	<input type="range"/> <input type="button" value="Reset"/>																		
HLC level	<input type="range"/> <input type="button" value="Reset"/>																		
Mask area	<input type="button" value="Start"/> <input type="button" value="End"/> <input type="button" value="Reset"/>																		
<table border="1"><tr><td colspan="3">Zoom</td></tr><tr><td><input type="button" value="⊖"/></td><td><input type="button" value="1"/></td><td><input type="button" value="⊕"/></td></tr><tr><td colspan="3">Focus</td></tr><tr><td><input type="button" value="Auto"/></td><td><input type="button" value="Near"/></td><td><input type="button" value="Far"/></td></tr><tr><td colspan="3">Brightness</td></tr><tr><td><input type="button" value="-"/></td><td><input type="button" value="Normal"/></td><td><input type="button" value="⊕"/></td></tr></table>		Zoom			<input type="button" value="⊖"/>	<input type="button" value="1"/>	<input type="button" value="⊕"/>	Focus			<input type="button" value="Auto"/>	<input type="button" value="Near"/>	<input type="button" value="Far"/>	Brightness			<input type="button" value="-"/>	<input type="button" value="Normal"/>	<input type="button" value="⊕"/>
Zoom																			
<input type="button" value="⊖"/>	<input type="button" value="1"/>	<input type="button" value="⊕"/>																	
Focus																			
<input type="button" value="Auto"/>	<input type="button" value="Near"/>	<input type="button" value="Far"/>																	
Brightness																			
<input type="button" value="-"/>	<input type="button" value="Normal"/>	<input type="button" value="⊕"/>																	
<input type="button" value="Close"/>																			

#### NOTE!

- Do not change other settings during preset position setting. The image may not be displayed correctly.
- The preset position cannot be set with the magnification of the digital zoom.
- Up to 256 preset positions can be set.
- Depending on the operating environment (+5 °C or less as a guideline), the speed of the preset movement may be slightly slower.

## Preset position setting

### Preset ID

Use **On** and **Off** to set whether the position name is displayed. You can set for each preset position.

**On:** Displays the position name.

**Off:** The position name is not displayed.

#### NOTE!

- If you have configured **Preset ID (0 - 9,A - Z)** and **Preset ID**, be sure to press **Register**.
- When set to **On**, the position name is displayed where you set the position in **Camera title position** on the **Basic** tab.

### Preset ID (0 - 9,A - Z)

Enter the name to be displayed on the image. You can set for each preset position. Number of characters that can be entered: 0 to 40 characters

Input Characters: 0-9 (single-byte), A-Z (single-byte, uppercase, lowercase), double-byte, single-byte symbol! " # \$ % & ' ( ) \* +, -, . /; =?

#### NOTE!

The position name entered is displayed next to the preset position number in the pull-down. If **Preset ID** is set to **On**, it can also be displayed on the images.

### Auto focus

Use **Auto** and **Off** to set whether auto focus is performed after the preset is moved. You can set for each preset position.

- **Auto:** Auto focus is performed after the preset is moved.
- **Off:** Auto focus is not performed after moving the preset.

**NOTE!**

When presetting a subject whose depth does not change, a subject whose contrast is low, or a subject with high brightness such as a spotlight, etc., set **Off** and register the preset position after setting the focus.

**Dwell time**

During the preset sequence operation, select the time to reflect the image of each preset position (the time when the camera stops rotating).

**NOTE!**

- The preset position set to **Off** does not move to that position during the preset sequence, but instead moves to the next preset position.
- Depending on the stop time setting, the camera may move to the next preset position during auto focus operation.
- Using this feature extensively will increase wear of the PTZ drive parts of the camera. You will have to replace the parts earlier than anticipated.

**Super Dynamic**

You can set **On** or **Off** to activate the super dynamic function. You can set for each preset position. This cannot be set when **Image capture mode** is **16:9 mode(60fps mode)** or **16:9 mode(50fps mode)**.

See **What is Super Dynamic** for details on super dynamic. **On**: The Super Dynamic function is activated. **Off**: Stops the superdynamic function.

**NOTE!**

- Set **Super Dynamic** to **Off** when the following phenomena are observed depending on the lighting condition.
  - When flickering or color changes occur
  - When noise is generated in the bright area of the screen
- If **Light control mode** is set to **Fix shutter**, **Super Dynamic** cannot be set to **On**.
- When **Stabilizer** is set to **On**, the superdynamic setting is **Off**.

**Level**

Adjust the superdynamic level.

When the slider bar is moved in the **+** direction, you can shoot a subject with a large difference in light and darkness without flipping white or shading black.

Move the slider bar in the **-** direction to take a full picture of the middle brightness. Press **Reset** to return to the default settings.

#### **BLC/HLC**

Select from the following. This setting is not available if **Super Dynamic** is set to **On** or **Intelligent Auto** is set to **On**.

- **Back Light Correction (BLC):** Enables the backlight correction function.
- **Intensity correction:** Enables the high light correction function. Illumination compensation suppresses bright lighting of subjects such as car headlights during nighttime.
- **Off:** Stops the backlight compensation function and the intense light correction function.

#### **BLC level**

Adjust the backlight correction level.

Moving the slider bar in the + direction improves the backlight correction effect. Moving the slider bar in the - direction reduces the effect of backlight correction. Press **Reset** to return to the default settings.

#### **HLC level**

Adjust the intensity correction level.

Moving the slider bar in the + direction improves the effect of intense light correction. Moving the slider bar in the - direction reduces the effect of intense light correction. Press **Reset** to return to the default settings.

#### **Mask area**

When the mask area is set, the set area can be masked and the light intensity can be adjusted. If **Super Dynamic** is set to **On**, it cannot be set.

For details on how to set the mask area, refer to the following.

→[Setting mask areas, p. 201](#)

#### **Zoom, Focus, Control Pad/Button, Brightness Button**

Please refer to the following instructions for operation.

→[Setting the privacy zone \(Privacy zone setting screen\), p. 210](#)

#### **Set button**

Register the preset position.

#### **Delete button**

Deletes the preset position selected by the position number.

#### **Close button**

Click this button to close the preset position setting window.

## Registering a preset position

1. Select the position number.

**Position No.** shows the selected position number.

→[Setting preset positions, p. 234](#)

If it is already registered, the camera moves to the preset position selected.

2. Move the camera direction in the direction you want to register.
3. If you want the position name to appear on the live image page, set **Preset ID** to **On** and enter the position name.
4. Set Auto Focus or Stop Time.
5. Press **Register**.
6. To set image quality for each position, set each item such as Super Dynamic. **Super Dynamic**, **BLC/ HLC**, and **Mask area** are reflected immediately.

### NOTE!

- When registering the preset position, the camera may move slightly.
- If **Image adjustScene file** is set to other than **Scene file is not applied**, **Super Dynamic**, **BLC/ HLC**, and **Mask area** cannot be set.

## Setting preset sequences

To **Preset sequence setting** Advanced Settings on the **Position** tabs of PTZ pages > >Click the **But-**  
**ton**.

→[Setting PTZ positions, p. 232](#)

Here, you can register, change, or delete the preset sequence. Up to three preset sequences can be set.

Preset sequence setting
+Preset sequence 1
+Preset sequence 2
+Preset sequence 3

## Preset sequence setting

Preset sequence setting

---

-Preset sequence 1

Select all	Cancel all						
<input type="checkbox"/> 1	<input type="checkbox"/> 2	<input type="checkbox"/> 3	<input type="checkbox"/> 4	<input type="checkbox"/> 5	<input type="checkbox"/> 6	<input type="checkbox"/> 7	<input type="checkbox"/> 8
<input type="checkbox"/> 9	<input type="checkbox"/> 10	<input type="checkbox"/> 11	<input type="checkbox"/> 12	<input type="checkbox"/> 13	<input type="checkbox"/> 14	<input type="checkbox"/> 15	<input type="checkbox"/> 16
<input type="checkbox"/> 17	<input type="checkbox"/> 18	<input type="checkbox"/> 19	<input type="checkbox"/> 20	<input type="checkbox"/> 21	<input type="checkbox"/> 22	<input type="checkbox"/> 23	<input type="checkbox"/> 24
<input type="checkbox"/> 25	<input type="checkbox"/> 26	<input type="checkbox"/> 27	<input type="checkbox"/> 28	<input type="checkbox"/> 29	<input type="checkbox"/> 30	<input type="checkbox"/> 31	<input type="checkbox"/> 32
<input type="checkbox"/> 33	<input type="checkbox"/> 34	<input type="checkbox"/> 35	<input type="checkbox"/> 36	<input type="checkbox"/> 37	<input type="checkbox"/> 38	<input type="checkbox"/> 39	<input type="checkbox"/> 40
<input type="checkbox"/> 41	<input type="checkbox"/> 42	<input type="checkbox"/> 43	<input type="checkbox"/> 44	<input type="checkbox"/> 45	<input type="checkbox"/> 46	<input type="checkbox"/> 47	<input type="checkbox"/> 48
<input type="checkbox"/> 49	<input type="checkbox"/> 50	<input type="checkbox"/> 51	<input type="checkbox"/> 52	<input type="checkbox"/> 53	<input type="checkbox"/> 54	<input type="checkbox"/> 55	<input type="checkbox"/> 56
<input type="checkbox"/> 57	<input type="checkbox"/> 58	<input type="checkbox"/> 59	<input type="checkbox"/> 60	<input type="checkbox"/> 61	<input type="checkbox"/> 62	<input type="checkbox"/> 63	<input type="checkbox"/> 64
<input type="checkbox"/> 65	<input type="checkbox"/> 66	<input type="checkbox"/> 67	<input type="checkbox"/> 68	<input type="checkbox"/> 69	<input type="checkbox"/> 70	<input type="checkbox"/> 71	<input type="checkbox"/> 72
<input type="checkbox"/> 73	<input type="checkbox"/> 74	<input type="checkbox"/> 75	<input type="checkbox"/> 76	<input type="checkbox"/> 77	<input type="checkbox"/> 78	<input type="checkbox"/> 79	<input type="checkbox"/> 80
<input type="checkbox"/> 81	<input type="checkbox"/> 82	<input type="checkbox"/> 83	<input type="checkbox"/> 84	<input type="checkbox"/> 85	<input type="checkbox"/> 86	<input type="checkbox"/> 87	<input type="checkbox"/> 88
<input type="checkbox"/> 89	<input type="checkbox"/> 90	<input type="checkbox"/> 91	<input type="checkbox"/> 92	<input type="checkbox"/> 93	<input type="checkbox"/> 94	<input type="checkbox"/> 95	<input type="checkbox"/> 96
<input type="checkbox"/> 97	<input type="checkbox"/> 98	<input type="checkbox"/> 99	<input type="checkbox"/> 100	<input type="checkbox"/> 101	<input type="checkbox"/> 102	<input type="checkbox"/> 103	<input type="checkbox"/> 104
<input type="checkbox"/> 105	<input type="checkbox"/> 106	<input type="checkbox"/> 107	<input type="checkbox"/> 108	<input type="checkbox"/> 109	<input type="checkbox"/> 110	<input type="checkbox"/> 111	<input type="checkbox"/> 112
<input type="checkbox"/> 113	<input type="checkbox"/> 114	<input type="checkbox"/> 115	<input type="checkbox"/> 116	<input type="checkbox"/> 117	<input type="checkbox"/> 118	<input type="checkbox"/> 119	<input type="checkbox"/> 120
<input type="checkbox"/> 121	<input type="checkbox"/> 122	<input type="checkbox"/> 123	<input type="checkbox"/> 124	<input type="checkbox"/> 125	<input type="checkbox"/> 126	<input type="checkbox"/> 127	<input type="checkbox"/> 128
<input type="checkbox"/> 129	<input type="checkbox"/> 130	<input type="checkbox"/> 131	<input type="checkbox"/> 132	<input type="checkbox"/> 133	<input type="checkbox"/> 134	<input type="checkbox"/> 135	<input type="checkbox"/> 136
<input type="checkbox"/> 137	<input type="checkbox"/> 138	<input type="checkbox"/> 139	<input type="checkbox"/> 140	<input type="checkbox"/> 141	<input type="checkbox"/> 142	<input type="checkbox"/> 143	<input type="checkbox"/> 144
<input type="checkbox"/> 145	<input type="checkbox"/> 146	<input type="checkbox"/> 147	<input type="checkbox"/> 148	<input type="checkbox"/> 149	<input type="checkbox"/> 150	<input type="checkbox"/> 151	<input type="checkbox"/> 152
<input type="checkbox"/> 153	<input type="checkbox"/> 154	<input type="checkbox"/> 155	<input type="checkbox"/> 156	<input type="checkbox"/> 157	<input type="checkbox"/> 158	<input type="checkbox"/> 159	<input type="checkbox"/> 160
<input type="checkbox"/> 161	<input type="checkbox"/> 162	<input type="checkbox"/> 163	<input type="checkbox"/> 164	<input type="checkbox"/> 165	<input type="checkbox"/> 166	<input type="checkbox"/> 167	<input type="checkbox"/> 168
<input type="checkbox"/> 169	<input type="checkbox"/> 170	<input type="checkbox"/> 171	<input type="checkbox"/> 172	<input type="checkbox"/> 173	<input type="checkbox"/> 174	<input type="checkbox"/> 175	<input type="checkbox"/> 176
<input type="checkbox"/> 177	<input type="checkbox"/> 178	<input type="checkbox"/> 179	<input type="checkbox"/> 180	<input type="checkbox"/> 181	<input type="checkbox"/> 182	<input type="checkbox"/> 183	<input type="checkbox"/> 184
<input type="checkbox"/> 185	<input type="checkbox"/> 186	<input type="checkbox"/> 187	<input type="checkbox"/> 188	<input type="checkbox"/> 189	<input type="checkbox"/> 190	<input type="checkbox"/> 191	<input type="checkbox"/> 192
<input type="checkbox"/> 193	<input type="checkbox"/> 194	<input type="checkbox"/> 195	<input type="checkbox"/> 196	<input type="checkbox"/> 197	<input type="checkbox"/> 198	<input type="checkbox"/> 199	<input type="checkbox"/> 200
<input type="checkbox"/> 201	<input type="checkbox"/> 202	<input type="checkbox"/> 203	<input type="checkbox"/> 204	<input type="checkbox"/> 205	<input type="checkbox"/> 206	<input type="checkbox"/> 207	<input type="checkbox"/> 208
<input type="checkbox"/> 209	<input type="checkbox"/> 210	<input type="checkbox"/> 211	<input type="checkbox"/> 212	<input type="checkbox"/> 213	<input type="checkbox"/> 214	<input type="checkbox"/> 215	<input type="checkbox"/> 216
<input type="checkbox"/> 217	<input type="checkbox"/> 218	<input type="checkbox"/> 219	<input type="checkbox"/> 220	<input type="checkbox"/> 221	<input type="checkbox"/> 222	<input type="checkbox"/> 223	<input type="checkbox"/> 224
<input type="checkbox"/> 225	<input type="checkbox"/> 226	<input type="checkbox"/> 227	<input type="checkbox"/> 228	<input type="checkbox"/> 229	<input type="checkbox"/> 230	<input type="checkbox"/> 231	<input type="checkbox"/> 232
<input type="checkbox"/> 233	<input type="checkbox"/> 234	<input type="checkbox"/> 235	<input type="checkbox"/> 236	<input type="checkbox"/> 237	<input type="checkbox"/> 238	<input type="checkbox"/> 239	<input type="checkbox"/> 240
<input type="checkbox"/> 241	<input type="checkbox"/> 242	<input type="checkbox"/> 243	<input type="checkbox"/> 244	<input type="checkbox"/> 245	<input type="checkbox"/> 246	<input type="checkbox"/> 247	<input type="checkbox"/> 248
<input type="checkbox"/> 249	<input type="checkbox"/> 250	<input type="checkbox"/> 251	<input type="checkbox"/> 252	<input type="checkbox"/> 253	<input type="checkbox"/> 254	<input type="checkbox"/> 255	<input type="checkbox"/> 256

Set

### Preset Sequence 1, Preset Sequence 2, Preset Sequence 3

Click on a preset sequence to select the positions you want to set.

- **Select all** buttons: Select all preset positions.
- **Cancel all** buttons: You can release all selections.
- **1~256**: Enables/disables the corresponding preset position.
- **Set**: Saves the settings of the created preset sequence.



**NOTE!**

- When the preset sequence is activated, the registered preset positions are moved from a younger number to a higher order.
- After moving to the trailing preset position, the system returns to the youngest number and moves the preset position back in sequence.

## Configuring auto pan

In the **Position** tab of the PTZ-page to the Advanced Settings tab of **Auto pan** > >Click the **Button**.

→[Setting PTZ positions, p. 232](#)

**NOTE!**

Using this feature extensively will increase wear of the PTZ drive parts of the camera. You will have to replace the parts earlier than anticipated.

## Detailed settings

### Setting the PTZ options

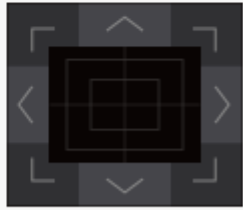
Auto pan setting		
Position		
Left end position setup	315°	<b>Set</b>
Right end position setup	45°	<b>Set</b>
Auto pan		
Dwell time	5s ▾	
Speed	13 °/s ▾	
Endless panning	Off ▾	
<b>Set</b>		
<b>Zoom</b>		
<b>Focus</b>		
<b>Brightness</b>		
<b>-</b>	<b>Normal</b>	<b>+</b>
Preset		
1: ▾		<b>Go</b>
<b>Close</b>		

## Setting the end point

### Start position

Use the **Zoom**, **Focus** and Control Pad/Buttons to move the camera to the desired position at the left end of the auto pan, and then press the **Set** button. Zoom and focus are set at the same time.

#### NOTE!

The pan, tilt, and zoom operations are also available on the images in the **Position** tabs.

## End position

Use the Control Pad/Button to move the camera to the desired position for the right end of the auto pan, and then press the **Set** button.

## Auto pan operation

### Dwell time

Select the stop time at the start and end positions.

### Speed

Select the pivot speed of the pan operation.

#### NOTE!

- If you set **Auto pan**, be sure to press **Set**.
- Even when the magnification of the digital zoom is set, the turn of the pan operation is performed at a position less than 34 times.
- **Zoom**, **Focus**, Control Pad/Button, **Brightness**, and Move presets buttons Please refer to the following instructions for operation.  
→[About live image pages, p. 44](#)

### Close button

Click this button to close the auto pan setting screen.

## Configuring patrol patterns

In the **Position** tab of the PTZ-page to the Advanced Settings tab of **Patrol** > >Click the **Button**. Here, information about patrols is set.

→[Setting PTZ positions, p. 232](#)

The patrol function stores the pan/tilt/zoom/focus and reproduces the stored operation.

#### NOTE!

Using this feature extensively will increase wear of the PTZ drive parts of the camera. You will have to replace the parts earlier than anticipated.

## Detailed settings

### Setting the PTZ options

Patrol

Number of patrol pattern

**Set**

Learn patrol pattern Patrol No.

**Learn** **Stop** **Confirm**

**Zoom**

**Brightness**

**Go**

**Close**

## Patrol setting

### Number of patrol pattern

Select the number of memories in the patrol. The amount of time that can be stored varies depending on the number of memories.

- 1: The operation for 2 minutes is stored in Patrol 1.
- 2: The operation for one minute is stored in Patrol 1 and Patrol 2.
- 4: The operation for 30 seconds is stored in Patrol 1, Patrol 2, Patrol 3, and Patrol 4.

#### NOTE!

When the number of memories is changed, the stored patrol operation is deleted.

### Learn patrol pattern

Select the patrol number (1 to 4) you want to set by clicking ▼ on the **Patrol No.**. The \* mark to the right of the patrol No. indicates that the patrol operation has already been stored. With Patrol No selected, clicking **Learn** starts storing the camera operation. The characters of **LEARNING(\*\*\*S)** are displayed during storage. \*\*\*S is the remaining time that can be stored. When **Stop** is clicked,

memory is stopped while the camera is in memory and reproducing is stopped while the camera is in reproduction. When the remaining time is 0 seconds (0S), the operation stops automatically. With Patrol No selected, clicking the **Execute** button reproduces the stored operation of the camera.

**NOTE!**

- The camera operations to be stored are as follows.
  - Operation start position memory
  - Pan tilt zoom focus position
  - When operating the camera
  - Move Pan Tilt Zoom Focus/Preset Position
- The auto focus function does not operate during the patrol operation. At this time, when zoom in from the WIDE side as a characteristic of the zoom lens, the focus is blurred. To store the zoom operation, start from the TELE side to prevent the focus from shifting.

**Zoom, Focus, Control Pad/Button, Brightness, and Move presets buttons**

Please refer to the following instructions for operation.

→[About live image pages, p. 44](#)

**Close button**

Click this button to close the Patrol Settings window.

**Configuring directions and angles**

In the **Position** tab of the PTZ-page to the Advanced Settings tab of **Direction/Angle setting** > > Click the **Button**. Here, you can set the direction/direction setting. When this page is displayed, it moves to the punch position set to north.

→[Setting PTZ positions, p. 232](#)

## Detailed settings

### Setting the PTZ options

---

Direction/Angle setting	
North point setting	<b>Set</b>
Display character setting	
N	<input type="text" value="N"/>
NE	<input type="text" value="NE"/>
E	<input type="text" value="E"/>
SE	<input type="text" value="SE"/>
S	<input type="text" value="S"/>
SW	<input type="text" value="SW"/>
W	<input type="text" value="W"/>
NW	<input type="text" value="NW"/>
	<b>Set</b>
Panning 0° direction setting	<b>Set</b> <b>Reset</b>
<b>Zoom</b>	
<input type="button" value="⊖"/>	<input type="button" value="*1"/> <input type="button" value="⊕"/>
<b>Focus</b>	
<input type="button" value="Auto"/>	<input type="button" value="Near"/> <input type="button" value="Far"/>
<b>Brightness</b>	
<input type="button" value="-"/>	<input type="button" value="Normal"/> <input type="button" value="⊕"/>
<b>Preset</b>	
<input type="text" value="1:"/> <input type="button" value="v"/>	<b>Go</b>
<b>Close</b>	

### Direction/Angle setting

If the **Camera position display** on the **Cam. Function** tab of the PTZ page is set to **Direction display**, the eight directions are displayed in the preset position title display position.

### North point setting

Set the orientation to be displayed as north (N) by adjusting the orientation of the pan and pressing **Set**.

### Display character setting

Individual names can be set for each direction.

### Panning 0° direction setting

Set the direction of the pan to 0°. If you adjust the field angle with the control pad/button and click the **Set** button, the direction of the pan you are presently pointing to will be 0°.

Press **Reset** to return to the default settings.

#### NOTE!

- Tilts are not set in the 0° direction.
- Changing the 0° direction of the pan does not change the position of the preset position already set. The set auto pan turns within the same range as before the change. Similarly, the same operation as before the change is performed for the patrol setting.

### Zoom, Focus, Control Pad/Button, Brightness, and Move presets buttons

Please refer to the following instructions for operation.

→[About live image pages, p. 44](#)

### Close button

Click this button to close the direction/direction setting window.

### Setting a pan/tilt range

In the **Position** tab of the PTZ-page to the Advanced Settings tab of **Pan/tilt range setting** > Click the **Button**.

→[Setting PTZ positions, p. 232](#) Here, the range of pan tilt is set.

## Detailed settings

### Setting the PTZ options

Cam. Function**Position**Auto trackAuto track alarm setting

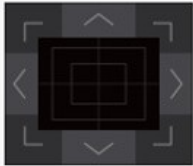

Pan/tilt range setting	<input type="radio"/> On	<input checked="" type="radio"/> Off	
Left end	Off	<input type="button" value="Set"/>	
Right end	Off	<input type="button" value="Set"/>	
Top end	Off	<input type="button" value="Set"/>	
Bottom end	Off	<input type="button" value="Set"/>	
Bottom end	Off	<input type="button" value="Set"/>	

### Pan/tilt range setting

On/Off sets whether to enable the range that restricts the pan tilt operation.

Set **On** and use the control pads/buttons to adjust the field angle to set **Left end**, **Right end**, **Top end** and **Bottom end**.

Adjust the angle of view with the control pad/button and press the **Set** button to view the angle at the set position.



**NOTE!**

- The **Left end** angle should be smaller than the **Right end** angle and the **Bottom end** angle should be larger than the **Top end** angle.
- Set **Pan/tilt range setting** on a screen that is not zoomed in.
- If you set the display size to 1.0 times (x1) on the zoomed display, a larger area than when the display was set (enlarged display) is displayed.
- Incorrect settings may cause you to view unexpected camera images. After setting, be sure to check the image using the pan tilt operation.
- Configure **Pan/tilt range setting** prior to setting the preset position. If the preset position is outside the range of **Pan/tilt range setting**, the preset position stops at the end of the range.
- When the pan/tilt range setting screen is displayed, the zoom factor is 1.0 times. During **Pan/tilt range setting**, **PT LIMIT SETTING** is displayed in the images.
- If you do not operate for 5 minutes, the **Pan/tilt range setting** will be disabled. To continue the operation, display the **Pan/tilt range setting** window again and set it.

## Configuring auto tracking

Click on the **Auto track setting** tab of the PTZ page.

Here, you can register, change, or delete auto tracking settings.

**NOTE!**

- Automatic tracking is not available in the following cases.
  - When **Image capture mode** is *16:9 mode(60fps mode)*, *16:9 mode(50fps mode)*, *4:3 mode(15fps mode)*, or *4:3 mode(12.5fps mode)*
  - When the **Light control modeMaximum shutter** of **Image adjust** is set to *Maximum 2/30s/Maximum 4/30s/Maximum 6/30s/Maximum 10/30s/Maximum 16/30s*
- Using this feature extensively will increase wear of the PTZ drive parts of the camera. You will have to replace the parts earlier than anticipated.

Automatic tracking is a function that automatically tracks and shoots an object when it is detected in a predetermined auto pan, preset sequence/preset position, patrol, or area.

## Detailed settings

### Setting the PTZ options

Cam. Function    Position    **Auto track**    Auto track alarm setting



- +Basic settings
- +Auto track activation setting
- +Auto track activation setting (Area)

## Basic settings

### Detection object

The object to be detected can be selected. You can select multiple objects.

- **Human:** Automatic tracking is performed when a person is detected.
- **Vehicle:** Automatic tracking is performed when a car is detected.
- **Bicycle:** Automatic tracking is performed when a motorcycle is detected.

### Object size

Select the size at tracking from the following.

- **Small (1/4 of the image):** Zoom the tracking object to the monitor screen up to about 1/4 (vertical) size.
- **Medium (1/2 of the image):** Zoom the tracking object to the monitor screen up to about 1/2 (vertical) size.
- **Large (3/4 of the image):** Zoom the tracking object to the monitor screen up to approx-

imately 3/4 (vertical) size.

- **No size adjustment:** Zoom control is not performed during tracking.

**NOTE!**

- The size is only a guide. Depending on the environmental conditions and tracking conditions, the assumed size may not be achieved.
- Increasing the size of the object to be tracked reduces the tracking performance.

### Sensitivity

Select the sensitivity during tracking from the following.

**NOTE!**

The lower the sensitivity, the less false detection due to wooden shaking, but the lower the tracking performance. On the other hand, higher sensitivity improves tracking performance, but it also increases false detection. Set according to the environment.

### Longest tracking time

Select the time from below from the start of auto-tracking to forced termination.

**NOTE!**

After the maximum tracking time, the camera stops in that position. When the auto mode operation is restored, the self-return time is counted and the auto mode operation is restored after the tracking is stopped by setting the self-return.

### Auto track data in video stream

Select whether to send the superimposed image data by adding auto-tracking information to the image.

- **Off:** Automatic tracking information is not added to the image.
- **On:** This feature adds automatic tracking information to images, but does not display target frames for objects under automatic tracking in live pictures.
- **On (with track video display):** This feature adds auto-tracking information to images and displays the target frame for objects under auto-tracking in live pictures.

### Auto track activation setting

#### Auto pan

Select whether or not to automatically track the user during auto panning.

## Detailed settings

### Setting the PTZ options

---

- **Enable:** Automatic tracking is started during auto panning.
- **Disable:** Automatic tracking is not started during auto pan.

### Preset sequence/Preset position

Choose whether to auto track in preset sequence or in preset position.

- **Enable:** Automatic tracking is started during the preset sequence or in the preset position.
- **Disable:** Automatic tracking is not started during preset sequence or preset position.

### Preset position selection

- **Select all** buttons: Select all preset positions.
- **Cancel all** buttons: You can release all selections.
- **1~256:** Toggle the corresponding preset position **On** or **Off**.
- **Set** button: Save the settings of the created preset sequence.

### Patrol

Select whether or not to automatically track when a tracking target is detected during patrol.

**Enable:** Start automatic tracking during patrol.

**Disable:** Automatic tracking is not started during patrol.

## Auto track activation setting (Area)

### Area select

When **Detection object** appears in the specified area, auto tracking can be started. Eight areas can be set.

- **Set** button: Sets the auto tracking start area to the specified area No.
- **Delete** button: Deletes the auto tracking area set to the specified area number.
- **Cancel** button: Cancels the setting of the currently set auto tracking area.

### Zoom, Focus, Control Pad/Button, Brightness, and Move presets buttons

Please refer to the following instructions for operation.

→[About live image pages, p. 44](#)

### Close button

Click this button to close the Auto Tracking Settings window.

**NOTE!**

- In the following cases, the target subject may not be tracked or may malfunction.
  - Low contrast between the subject and the background.
  - If the dome is moist or dirty Large variation in illumination.
  - When there are many movements other than the subject.
  - When the subject moves directly below the camera.
  - If flickering is severe.
  - Reflection of light through windows, reflection of road surfaces, reflection of back-light into the dome, etc.
  - When a tracking object is hidden in the pole or behind the object.
  - When multiple subjects intersect or crowd.
  - When the subject moves too fast or too slowly
  - If the subject is too small or too large
  - If the camera is swaying.
  - If the weather is very bad.
  - When the image correction function is ON.
  - It is recommended to use the product in the following installation environment to increase the detection accuracy.
    - --more than about 1/5 (vertical) of the size of the monitor screen
- We shall not be liable for any inconvenience, damage, or damage caused by the automatic tracking function settings or the results.

## Setting up automatic tracking between cameras

When two or more cameras with automatic tracking function are used, the tracking of objects can be coordinated between the cameras.

As an example, as shown in the figure below, the procedure for setting the connection from Camera 1 (IP address: 192.168.0.11) to Camera 2 (IP address: 192.168.0.12) when the tracking target enters the alarm area No.1.

## Detailed settings

### Setting the PTZ options

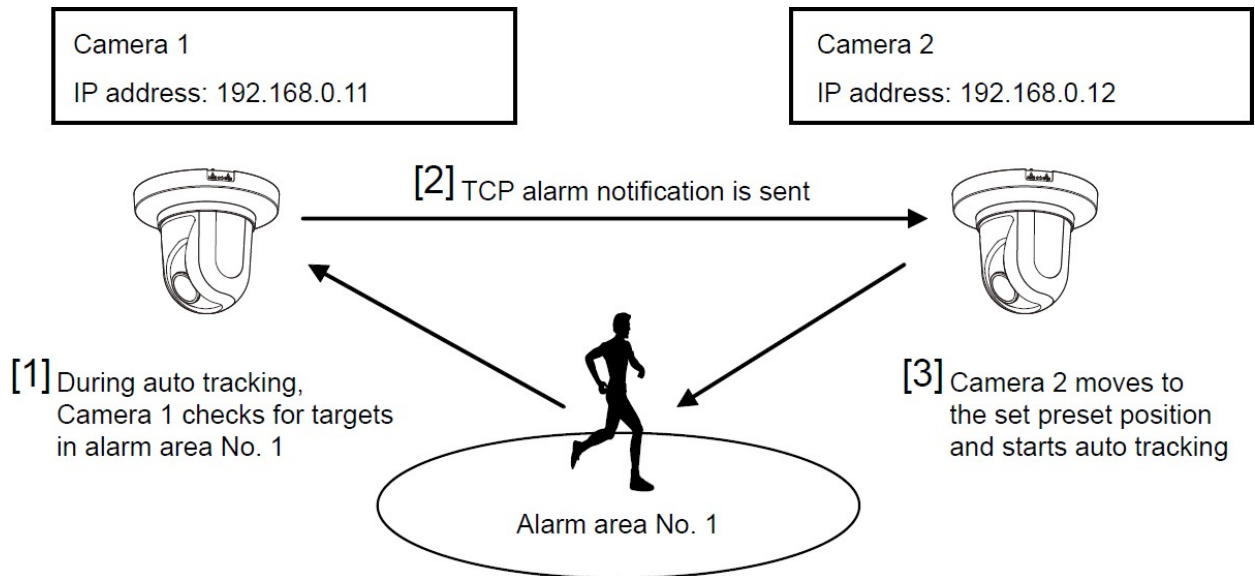

### To configure auto tracking

1. Set the alarm area for the area for which automatic tracking is desired in Camera 1.
  1. The auto tracking setting screen is displayed.
  2. Select **On(In preset alarm area)** in **Auto track alarm** and press **Set**.
  3. In the Alarm area **Area select**, select 1 from the **Area No.** pull-down.
  4. While looking at the screen, perform pan tilt zoom to set the alarm area.
  5. Press **Set**.
2. Set the preset position to move when receiving the unique notification command in camera 2. (Set the preset position so that the alarm area No.1 of Camera 1 set in step 1 enters the screen.)
  1. The preset position setting screen is displayed.  
→[Setting preset positions, p. 234](#)
  2. Select the desired number from the **Preset** pull-down list.
  3. While viewing the screen, set the preset position by using the pan tilt zoom.
  4. Press **Register**.

3. Set Camera 1 (IP address: 192.168.0.11) to notify the command.
  1. The Alarm Page **Notification** window is displayed.
  2. →[Configuring alarm notifications, p. 287](#)
  3. Set **TCP alarm notification** to **On** and press **Set**.
  4. In the **Destination of notification** **Notify Destination 1** (which may be selected), check the **Alarm** checkbox and insert 192.168.0.12 in the **Destination address**.
  5. Set **Auto track cooperation** to **On** and select Alarm area No. 1.
  6. Press **Set**.
4. Set Camera 2 (IP address: 192.168.0.12) to receive the command.
  1. The Alarm Page **Alarm** window is displayed.
  2. →[Configuring alarms, p. 258](#)
  3. Set the **AlarmCommand alarm** to **On** and press **Set**.
  4. Set the **Camera action on alarmCommand alarm** to **Preset per sender** and press **Preset per sender**.
  5. On the Preset by Source window, check Auto Tracking of **Source Address 1** (any Source Address may be selected), enter the Source Address 192.168.0.11 (Camera 1), select the preset position to move when receiving the command set in step 2, click **Set**, and close the pages.
  6. →[Moving to preset positions according to alarms from specific senders, p. 268](#)
  7. Press **Set**.
5. By starting the automatic tracking operation of camera 1, the automatic tracking linkage function can be used.

## Setting up auto track alarms

Click on the **Auto track alarm setting** tab of the PTZ page. Here, you can set the automatic tracking alarm.

#### NOTE!

- Automatic tracking is not available in the following cases.
  - When **Image capture mode** is **16:9 (60 fps mode)**, **16:9 (50 fps mode)**, **4:3(15 fps mode)**, **4:3 (12.5 fps mode)**
  - When the **Light control modeMaximum shutter** of **Image adjust** is set to *Maximum 2/30s/Maximum 4/30s/Maximum 6/30s/Maximum 10/30s/Maximum 16/30s*
- Using this feature extensively will increase wear of the PTZ drive parts of the camera. You will have to replace the parts earlier than anticipated.

The auto tracking function automatically tracks and shoots the subject when movement is detected in the pre-set alarm area.



Cam. Function    Position    Auto track    **Auto track alarm setting**



Auto track alarm	Off
Alarm wait time	10s

**Set**

Alarm area

Area select	Area No.    ▾
Area No. notification	<a href="#">TCP alarm notification &gt;&gt;</a>

\* When notifying alarm area numbers by the TCP alarm notification, set "Additional alarm data" to "On".

**Set**    **Delete**    **Cancel**

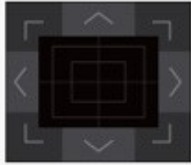
<b>Zoom</b> ⊖    ⊕		<b>Brightness</b> - <b>Normal</b> +
<b>Focus</b> <b>Auto</b> <b>Near</b> <b>Far</b>		<b>Preset</b> 1:    ▾ <b>Go</b>

## Auto track alarm setting tab

### Auto track alarm

Select the alarm during automatic tracking from the following.

- **Off:** Alarm is not output.
- **On (Immediate):** During automatic tracking, the alarm will continue to be output. The output interval is every 5 seconds.
- **On (After alarm wait time):** The alarm is output only once when automatic tracking continues for a certain period of time.
- **On (In preset alarm area):** During automatic tracking, the alarm is output only once when a tracking object is in the set alarm area. Refer to **Alarm area** for the alarm settings.

## Alarm wait time

If **Auto track alarm** is set to **On(After alarm wait time)**, select the time wait.

## Alarm area

### Area select

Click ▼ on the **Area No.** and select the area number (1 to 8) to be set. The \* mark to the right of the area No. indicates that the area is already stored. The alarm area is enabled when On (when the alarm area enters) is selected for automatic tracking alarm.

### Area No. notification

Clicking **TCP alarm notification setup** displays the **Notification** tabs on the Alarm Page.

→[Configuring alarm notifications, p. 287](#)

#### NOTE!

The alarm area cannot be set individually for each preset position. The configured area is valid for all preset positions.

# Working with alarms

The alarm page is used to set the alarm operation using the external I/O terminal of the camera, the alarm image, the area to detect the alarm, and the alarm notification. The Alarm page consists of the **Alarm**, **VMD area**, **SCD area**, **Audio detection**, and **Notification** tabs.

## Configuring alarms

Click **Alarm** on the Alarm page. Refer to the following how to display and operate the **Detailed settings** menu.

→[Accessing the camera settings menu, p. 109](#)

→[Editing the camera settings, p. 111](#)

This is used to set the operation when an alarm is detected. For the alarm image and output terminal settings, refer to the following.

→[Using alarms to execute camera actions, p. 265](#)

→[Configuring output terminal alarms, p. 262](#)

## Alarm

### Terminal 1

Set the operation of terminal 1.

- **Off:** Not used
- **Alarm input (TRM1):** The alarm input is received. When Alarm is selected, a pull-down menu is displayed.
  - **Close:** When the terminal status changes to **Close**, an alarm is detected.
  - **Open:** When the terminal status changes to **Open**, an alarm is detected.
  - **Close (Continue):** When the terminal status changes to **Close**, an alarm is detected. When the terminal status is **Close**, the alarm is detected periodically at intervals of no alarm detection time.
  - **Open (continue):** When the terminal status changes to **Open**, an alarm is detected. When the terminal status is **Open**, the alarm is detected periodically at intervals of no alarm detection time.
- **Black and white switching input:** The black-and-white selector input is received. (When the input is **On**, the input is switched to black and white)
- **Automatic Time Adjustment:** Time setting by terminal input is accepted. When the signal is input, set to 00 minutes 00 seconds if the time difference from the normal time (00 minutes per hour) is 29 minutes or less. In the case of returning the time less than 5 seconds during SD recording, the time is not changed. Selecting Auto Time Adjustment displays the pull-down menu for short circuit and release selection.
  - **Close:** When the terminal status changes to **Close**, the time is automatically adjusted.
  - **Open:** When the terminal status changes to **Open**, the time is automatically adjusted.

### Terminal 2

Set the operation of terminal 2.

- **Off:** Not used
- **Alarm input (TRM2):** The alarm input is received. When Alarm is selected, a pull-down menu is displayed.
  - **Close:** When the terminal status changes to **Close**, an alarm is detected.
  - **Open:** When the terminal status changes to **Open**, an alarm is detected.
  - **Close (Continued):** When the terminal status changes to **Close**, an alarm is detected. When the terminal status is **Close**, the alarm is detected periodically at intervals of no alarm detection time.
  - **Open (continued):** When the terminal status changes to **Open**, an alarm is detected. When the terminal status is **Open**, the alarm is detected periodically at intervals of no alarm detection time.
- **Alarm Output:** Alarm outputs according to the setting in **Output terminal**.
- →[Configuring output terminal alarms, p. 262](#)

## Terminal 3

Set the operation of terminal 3.

- **Off:** Not used
- **Alarm input (TRM3):** The alarm input is received. When Alarm is selected, a pull-down menu is displayed.
  - **Close:** When the terminal status changes to **Close**, an alarm is detected.
  - **Open:** When the terminal status changes to **Open**, an alarm is detected.
  - **Close (Continued):** When the terminal status changes to **Close**, an alarm is detected. When the terminal status is **Close**, the alarm is detected periodically at intervals of no alarm detection time.
  - **Open (continued):** When the terminal status changes to **Open**, an alarm is detected. When the terminal status is **Open**, the alarm is detected periodically at intervals of no alarm detection time.
- **Aux output:** AUX output is performed. The **AUX** buttons appear on the live picture pages.

**CAUTION!**

- It takes approximately 100 ms or longer to detect an alarm input to a short circuit (ON) or an alarm input to an open circuit (OFF) of the external I/O terminal. The alarm input will not be detected until the time set by **Alarm deactivation time** has elapsed.
- AUX is a camera terminal that can be operated (opened/closed) by the operator from the live image page. For example, when you want to operate lighting in the location where the camera is installed, you can operate it remotely by connecting it to a lighting control device.
- For the input/output ratings of each terminal, refer to the installation manual of the model.

## VMD alarm

Clicking **VMD** displays the **VMD area** tabs on the Alarm Page.

→Defining VMD areas for motion detection, p. 279

## Scene change detection (SCD) alarm

Clicking **SCD** displays the **SCD area** tabs on the Alarm Page.

→Defining SCD areas for screen change detection, p. 283

## Auto track alarm

Clicking **Auto track setting** displays the **Auto track alarm setting** tabs for the PTZ pages.

→Setting up auto track alarms, p. 255

## Audio detection alarm

Clicking **Audio detection** displays the **Audio detection** tabs on the Alarm Page.

→Configuring audio detection, p. 285

## Command alarm

Use **On** or **Off** to specify whether or not to accept the command alarm.

Command alarm is a function to receive unique alarm notification from other cameras. When set to **On**, the alarms can be operated in conjunction with several cameras.

## Reception port

Set the port number to which the command alarm is received.

Allowed values: 1~65535

The following port numbers cannot be set because they are used by this camera.

20, 21, 23, 25, 42, 53, 67, 68, 69, 80, 110, 123, 161, 162, 443, 554, 995, 1883, 8883, 10669, 10670, 59000~61000

#### Alarm deactivation time

Sets the time when the alarm is detected and the detection operation is not executed. For example, this setting prevents sending too much mail to a mobile terminal or a tablet terminal when it is set to send mail notification by an alarm.

##### NOTE!

- Alarm detection time is managed for each alarm type. For example, the operation detection alarm and screen change detection alarm are detected even during the no alarm detection time of the command alarm.
- <Multisensor>: The port numbers 32768 to 49151 cannot be set.

#### Alarm test

Clicking **Execute** performs the alarm test function.

##### NOTE!

- When the alarm test function is executed, the camera detects the command alarm. This function can be used to record an SD card triggered by alarm detection or to confirm notification to an external device. Use the external device specified as the notification destination and the system log of this equipment to check the related settings.
- The alarm test function cannot be generated more than once within the alarm detection time.

## Configuring output terminal alarms

Click **Alarm** on the Alarm page. Refer to the following how to display and operate the **Detailed settings** menu.

→[Accessing the camera settings menu, p. 109](#)

→[Editing the camera settings, p. 111](#)

Here, the output terminal is set.

### Output terminal

For the output terminal function, the **Terminal 2** of the **Alarm** setting must be set to **Alarm output**.

#### Terminal output upon alarm detection

Sets on/off whether an alarm signal is output to the output terminal when an alarm is detected.

## SD card error

The **On** or **Off** is used to determine whether to output signals to the output terminals when an SD card alarm is detected.

- **SD card Alarm Detection Conditions:** SD card error (write error, read error, etc.), Operating time: 6 years, Overwrite count: 2,000 times
- **On:** When the alarm condition is detected, a signal is output to the output terminal and **Alarm notification** of the live picture is popped.
- **Off:** Stops detecting the alarm condition.

### NOTE!

- To use this function correctly, format the SD card on your computer before using the SD card.
- Operation time: For 6 years, the power-on time after the SD card is inserted into the camera, and for 2000 times, the upper limit of the number of business SD card (MLC type) rewrites is used as a guide, and this does not guarantee a durability period.
- The output terminal and SD card Alarm use the same output terminal.
- When either an alarm or SD card alarm is activated, a signal is output to the output terminal.
- When an SD card Alarm is detected, the **Alarm Notice** on the live image page is popped out. Click the **x** button of **Alarm notification** to clear the **Alarm notification** display.
- The output signal output by the SD card alarm depends on the alarm format setting.
  - In the case of latches: The output signal continues for the duration of the cause of the SD card warning even after the alarm notification is cleared.
  - For pulses: The signal output of the output terminal continues while the cause of the SD card warning persists even after the alarm notification is cleared. However, when the time set in **Alarm output time** has elapsed, the signal output of the output terminal stops.

## Terminal state upon alarm detection

Set the output terminal operation when an alarm is detected to either **Latch** or **Pulse**.

- **Latch:** When an alarm is detected, the alarm output terminal is set to **Terminal action upon alarm detection** until **x** is clicked in **Alarm notification**.
- **Pulse:** When an alarm is detected, the terminal at the time of alarm outputting is set by **Terminal action upon alarm detection** for the period set by **Pulse output width**. Click the **x** button of **Alarm notification** to return the output terminal to the normal state.

## Terminal action upon alarm detection

Set the output status of the alarm output from the output terminal by **Open** or **Close**.

- **Open:** Set the alarm output terminal to Open (usually Close).
- **Close:** The terminal at the time of alarm output is closed (normally open).

### NOTE!

When set to **Open**, the alarm will be output for approximately 20 seconds when the power to the camera is turned on.

## Pulse output width

Sets the time when the alarm is output from the output terminal when **Pulse** is selected in **Terminal state upon alarm detection**.

# Using alarms to change the AUX name

Click **Alarm** on the Alarm page. See the following for how to display and operate the **Detailed settings** menu.

→[Accessing the camera settings menu, p. 109](#)

→[Editing the camera settings, p. 111](#)

You can change the **AUX**, **Open**, and **Close** names for live picture pages.

## AUX title

### AUX

Enter the **AUX** name for the live picture page (up to 10 characters). Characters that cannot be entered: Half-pitch symbol " &

### Open

Enter the **Open** name for the **AUX** buttons on the live picture pages (up to 5 characters). Characters that cannot be entered: Half-pitch symbol " &

### Close

Enter the **Close** name for the **AUX** buttons on the live picture pages (up to 5 characters). Characters that cannot be entered: Half-pitch symbol " &



**NOTE!**

- The AUX name can be changed when **Terminal 3** in the **Alarm** setting is set to **AUX output**.
- AUX is a camera terminal that can be operated (Open/Close) by the operator from the live picture page. For example, when you want to operate lighting in the location where the camera is installed, you can operate it remotely by connecting it to a lighting control device.

## Using alarms to execute camera actions

Click **Alarm** on the Alarm page. Refer to the following how to display and operate the **Detailed settings** menu.

→[Accessing the camera settings menu, p. 109](#)

→[Editing the camera settings, p. 111](#)

This section sets the function to execute in conjunction with the alarm.

**NOTE!** <PTZ>: **Terminal alarm 1, Terminal alarm 2, Terminal alarm 3, VMD alarm, Scene change detection (SCD) alarm, Audio detection alarm, and Command alarm** can only be set for PTZ cameras.

### Terminal alarms 1 to 3

Select the action to be executed when the corresponding terminal alarm is detected. This can be set when **Terminal *n*** of the alarm is set to **Alarm input(TRM*n*)**.

- **Off:** Interlock operation is not performed even if the corresponding terminal alarm is detected.
- **1~256:** Moves the camera to the selected position when this alarm is detected.
- **Patrol *n*:** When the corresponding terminal alarm is detected, patrol starts. \*If **Patrol *n*** is not registered, it will not be displayed.

### VMD alarm

Select the action to be linked to the alarm detected by the motion detector from the following.

- **Off:** When an alarm is detected by the motion detector, no action will be executed.
- **1~256:** Moves the camera to the selected position when this alarm is detected.
- **Patrol 1:** When an alarm is detected by the motion detector, a patrol is started. \*If **Patrol 1** is not registered, it is not displayed.

## Scene change detection (SCD) alarm

Select the action to be interlocked when an alarm is detected by the undesired signal detection from the following.

- **Off:** Interlock operation is not performed even if an alarm is detected by undesired signal detection.
- **1~256:** Moves the camera to the selected position when this alarm is detected.
- **Patrol 1:** When an alarm is detected by the motion detector, a patrol is started. \*If **Patrol 1** is not registered, it is not displayed.

## Audio detection alarm

Select the action to be executed upon detecting an audio alarm.

- **Off:** The product does not perform interlocked operation even if an alarm is detected by sound detection.
- **1~256:** Moves the camera to the selected position when this alarm is detected.
- **Patrol 1:** When an alarm is detected by the motion detector, a patrol is started. \*If **Patrol 1** is not registered, it is not displayed.

## Command alarm

Select the action to be linked to the alarm by the command alarm from the following. This can be set when **Command alarm** is set to **On**.

- **Off:** The product does not operate in conjunction with the command alarm.
- **1~256:** Moves the camera to the selected position when this alarm is detected.
- **Patrol 1:** When an alarm is detected by the motion detector, a patrol is started. \*If **Patrol 1** is not registered, it is not displayed.

## Source-specific preset position

Register the address of the sender of the command alarm and the preset position corresponding to that address, and move to that position when the alarm is detected by the command alarm.

When **Preset per sender** is clicked, a separate window opens showing the settings for the source-specific preset position.

→[Moving to preset positions according to alarms from specific senders, p. 268](#)

## Command Alarm Action-Source Address

The IP address of the PTZ camera for the Multisensor/PTZ integrated camera is displayed.

## Operation at Command Alarm Interlocked operation

Select the action linked to the command alarm when received from the following.

- **Off:** Interlock operation is not performed even if a command alarm is received.
- **Alarm interlock:** Alarm operation is performed after the command alarm is received.
- **Switching between black and white:** Switches between black and white after receiving the command alarm.
- **Automatic Time Adjustment:** Adjusts the time after the command alarm is received.

## Email notification

When **Email notification setup** is clicked, the setting window for the email when the alarm is generated is displayed in a separate window.

→[Setting up email notification for alarms, p. 269](#)

## Alarm image FTP/SFTP transmission

When **FTP/SFTP setup** is clicked, a separate window is displayed for FTP/SFTP sending when an alarm is generated.

→[Setting up FTP/SFTP file transfer for alarms, p. 269](#)

## Alarm image recording(SD card)

When **SD card setup** is clicked, the settings for recording to the SD card when an alarm is generated are displayed in a separate window.

→[Setting up SD card recording for alarms, p. 270](#)

## TCP alarm notification

When **TCP alarm notification setup** is clicked, the setting window for sending unique alarm notification when alarm is generated is displayed in a separate window.

→[Setting up unique alarm notification for alarms, p. 271](#)

## HTTP alarm notification

When **HTTP alarm notification setup** is clicked, the setting window for sending HTTP alarm notification when alarm is generated is displayed in a separate window.

→[Setting up HTTP alarm notification for alarms, p. 271](#)

### SNMP transmission upon alarm detection

When **To SNMP setting** is clicked, the setting window for sending SNMP when an alarm is generated is displayed in a separate window.

→[Setting up SNMP alarm notification for alarms, p. 271](#)

### Moving to preset positions according to alarms from specific senders

On the **Alarm** tab of the Alarm page, press **Preset per sender** in **Command alarm**.

→[Configuring alarms, p. 258](#)

Here, the address of the source of the command alarm and the preset position corresponding to that address are registered.

Preset per sender						
Sender's address 1	<input type="text"/>	Off	<input type="radio"/> On <input checked="" type="radio"/> Off	Notification per Camera	Alarm area No.	Reception setting during live view
Sender's address 2	<input type="text"/>	Off	<input type="radio"/> On <input checked="" type="radio"/> Off	Notification per Camera	Alarm area No.	Reception setting during live view
Sender's address 3	<input type="text"/>	Off	<input type="radio"/> On <input checked="" type="radio"/> Off	Notification per Camera	Alarm area No.	Reception setting during live view
Sender's address 4	<input type="text"/>	Off	<input type="radio"/> On <input checked="" type="radio"/> Off	Notification per Camera	Alarm area No.	Reception setting during live view
Sender's address 5	<input type="text"/>	Off	<input type="radio"/> On <input checked="" type="radio"/> Off	Notification per Camera	Alarm area No.	Reception setting during live view
Sender's address 6	<input type="text"/>	Off	<input type="radio"/> On <input checked="" type="radio"/> Off	Notification per Camera	Alarm area No.	Reception setting during live view
Sender's address 7	<input type="text"/>	Off	<input type="radio"/> On <input checked="" type="radio"/> Off	Notification per Camera	Alarm area No.	Reception setting during live view

**Set** **Close**

### Sender's address 1 to 48

Set the IP address of the sender of the command alarm and the preset position to move corresponding to the IP address. You can set up to 48 notifications.

## Notification per Camera

If the transmission source is a Multisensor camera, select the camera number of the transmission source. Otherwise, select **1**.

## On/Off (Alarm area no. interlock)

Use **On/Off** to set whether or not to link with **Alarm area No.**.

## Alarm area No.

When **Alarm Area No. Interlock** is set, select the sender alarm area No. from 1 to 8.

## On/Off (Reception setting during live view)

On/Off is used to select whether to link with the clicking operation of the live image of the Multi-sensor camera.

## Close button

Click this button to close the window.

## Setting up email notification for alarms

On the **Alarm** tab of the Alarm page, press **Email notification setup** in **Camera action on alarm**.

→[Configuring alarms, p. 258](#) Refer to the following for the setting method.

→[Configuring SMTP \(E-mail\), p. 315](#)

## Setting up FTP/SFTP file transfer for alarms

On the **Alarm** tab of the Alarm page, press **FTP/SFTP setup** in **Camera action on alarm**.

→[Configuring alarms, p. 258](#) Refer to the following for the setting method.

→[Configuring FTP/SFTP transmission function, p. 319](#)

### NOTE!

Only models with FTP/SFTP functions can be set.

## Detailed settings

### Working with alarms

Transmission protocol	<input type="radio"/> FTP <input checked="" type="radio"/> SFTP
Alarm setting	
Alarm image transmission	<input type="radio"/> On <input checked="" type="radio"/> Off
Directory name	<input type="text"/>
File name	<input type="text"/> <input checked="" type="checkbox"/> Terminal 1 <input checked="" type="checkbox"/> Terminal 2 <input checked="" type="checkbox"/> Terminal 3 <input checked="" type="checkbox"/> VMD <input checked="" type="checkbox"/> SCD <input checked="" type="checkbox"/> Auto track <input checked="" type="checkbox"/> Command alarm <input checked="" type="checkbox"/> Audio detection <small>* For alarms by the "Ext. software", alarm images will be transmitted only by configuring the alarm image SFTP transmission.</small>
FTP transmission retry	<input type="radio"/> On <input checked="" type="radio"/> Off
Pre alarm	Transmission interval: <input type="text" value="1fps"/> Maximum number of images: <input type="text" value="0 pic"/> Recording duration: 0s
Post alarm	Transmission interval: <input type="text" value="1fps"/> Number of images: <input type="text" value="100 pics"/> Recording duration: 100s
Image capture size	<input type="text" value="JPEG(2)"/> (640x360)
SFTP server setting	
SFTP server address	<input type="text"/> Example of entry: 192.168.0.10
Port number	<input type="text" value="22"/> (1-65535)
Host key hash	SHA256: <input type="text"/> Example of entry: dqVcdVZ/2ySO5tz/R6YR+rpbW6dnap6P743uiMV0cf0
User name	<input type="text"/>
Password	<input type="password"/>
FTP server setting	
FTP server address	<input type="text"/> Example of entry: 192.168.0.10
User name	<input type="text"/>
Password	<input type="password"/>
Control port	<input type="text" value="21"/> (1-65535)
FTP mode	<input checked="" type="radio"/> Passive <input type="radio"/> Active
<input type="button" value="Set"/> <input type="button" value="Close"/>	

## Setting up SD card recording for alarms

On the **Alarm** tab of the Alarm page, press **SD card setup** in **Camera action on alarm**.

→[Configuring alarms, p. 258](#)

Refer to the following for the setting method.

→[SD card options, p. 154](#)

## Setting up unique alarm notification for alarms

On the **Alarm** tab of the Alarm page, press **TCP alarm notification setup** in **Camera action on alarm**.

→[Configuring alarms, p. 258](#)

Refer to the following for the setting method.

→[Configuring unique alarm notifications, p. 288](#)

## Setting up HTTP alarm notification for alarms

On the **Alarm** tab of the Alarm page, press **HTTP alarm notification setup** in **Camera action on alarm**.

→[Configuring alarms, p. 258](#)

Refer to the following for the setting method.

→[Configuring HTTP alarm notifications, p. 291](#)

## Setting up SNMP alarm notification for alarms

On the **Alarm** tab of the Alarm page, press **To SNMP setting** in **Camera action on alarm**.

→[Configuring alarms, p. 258](#)

Refer to the following for the setting method.

→[Configuring SNMP, p. 332](#)

## Configuring motion detection using VMD areas

Click **VMD area** on the Alarm page. Refer to the following how to display and operate the **Detailed settings** menu.

→[Accessing the camera settings menu, p. 109](#)

→[Editing the camera settings, p. 111](#)

Here, the area for detecting the movement of an object using the motion detector function is set. An alarm is activated when the movement of an object in the set area is detected.

#### NOTE!

- <PTZ>: Up to four areas can be set for each preset position (up to 256).
- <PTZ>: You can also set the alarm operation when the camera is at a position other than the preset position.
- <Multisensor>: Up to four areas can be set for each camera.
- When the motion detector function is used to detect the movement of an object, **Alarm notification** is displayed for confirmation.  
→[About live image pages, p. 44](#)
- **Alarm notification** is also displayed when the alarm input is received with the terminal alarm or when the command alarm is received.
- Depending on the network environment, notification may be delayed.
- If the **Image capture mode** of the **Basic** tabs is changed after the operation detection area is set, the operation detection area may be misaligned. Be sure to check the setting of the motion detection area again.
- When **Intelligent Auto** is set to **On**, the operation detection alarm may be generated because the brightness of the entire image changes depending on the subject's condition. In this case, set one of the following settings.
  - Set **Illumination detection suppression** to **On** for motion detection.
  - Adjust the slider bar of the **Detection sensitivity** in the motion detection area to the **Low** direction.
- Adjust the **Face priority level (Brightness)** slider bar of the intelligent auto to -.
- The motion detector function is not intended to prevent theft, fire, etc. We will not be liable for any accident or damage.

## Selecting positions and adding information

#### NOTE!

<PTZ>: Only the PTZ camera can be used to select positions and for adding information.



Alarm	<b>VMD area</b>	SCD area	Audio detection	Notification
-------	-----------------	----------	-----------------	--------------



VMD area setting

Select a preset position	except the preset positions	<b>Start</b>
--------------------------	-----------------------------	--------------

VMD information addition

Information addition	<input type="radio"/> On	<input checked="" type="radio"/> Off
----------------------	--------------------------	--------------------------------------

**Set**

## VMD area setting

### Select a preset position

Select the preset position number for which the motion detection area is to be set and press **Start** to set the motion detection area.

Select **except the preset positions** to set the operation detection area other than the preset position.

## VMD information addition

### Information addition

Sets whether to send the superimposed image data by **On** or **Off** by adding motion detection data to the image.

## Detailed settings

### Working with alarms

The operation detection information can be used by some of the search functions of the network disk recorder manufactured by us.

For details of the functions and settings, refer to the instruction manual of the connected device.

## Operation detection area setting screen

### PTZ camera

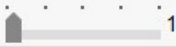
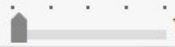
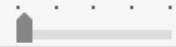
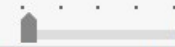
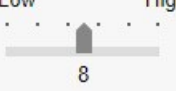
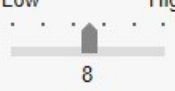
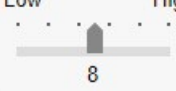
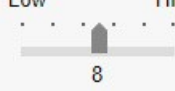
Alarm	VMD area	SCD area	Audio detection	Notification
				
except the preset positions				<b>All areas</b>
Area	1(White) <input type="checkbox"/>	2(Blue) <input type="checkbox"/>	3(Green) <input type="checkbox"/>	4(Red) <input type="checkbox"/>
Status	<input type="radio"/> On <input checked="" type="radio"/> Off	<input type="radio"/> On <input checked="" type="radio"/> Off	<input type="radio"/> On <input checked="" type="radio"/> Off	<input type="radio"/> On <input checked="" type="radio"/> Off
Detection area	 1	 1	 1	 1
Detection sensitivity	 8	 8	 8	 8
Delete	<b>Delete</b>	<b>Delete</b>	<b>Delete</b>	<b>Delete</b>
Light detection control	<input type="radio"/> On <input checked="" type="radio"/> Off			
Area No. notification	<a href="#">TCP alarm notification &gt;&gt;</a>			
<p>* When notifying alarm area numbers by the TCP alarm notification, set "Additional alarm data" to "On".</p> <p>* Various functions working with VMD alarm do not work while this page is open. After setting, close this page.</p>				
<b>Set</b>		<b>Back</b>		

## Area

When the motion detection area is selected in the image, it is set in order from Area 1.

### All areas buttons

Clicking this button selects the entire area as the motion detection area and sets it to the **1(White)** of Area.

### Status

Enable/disable operation detection.

- **On:** Operation detection is performed.
- **Off:** Operation detection is not performed.

### Detection area

Set the area of the slider bar to detect movement of the subject in the motion detection area. The smaller the set value, the smaller the movement of the subject is detected. The current setting (1 to 10) is displayed to the right of the slider bar.

### Detection sensitivity

Use the slider bar to set the sensitivity for detecting movement in the area. Individual settings can be made for each area. The larger the set value, the easier it is to sense the movement.

The current setting (1 (Low) to 15 (High)) is displayed under the slider bar.

### Delete button

Click the area button to delete the area frame.

### Light detection control

Use the **On** and **Off** buttons to specify whether or not the operation is not detected due to changes in the illumination.

#### NOTE!

- If the lighting intensity is small, it may be impossible to suppress it.
- When the illumination detection suppression is set to **On** and the subject with movement throughout the screen is detected, the operation detection may not be performed.

### Area No. notification

Clicking **TCP alarm notification setup** displays the **Notification** tabs on the Alarm Page.

→[Configuring alarms, p. 258](#)

## Adding motion detection information

### Information addition

Adds motion detection information to images and sets on/off whether to transmit superimposed image data. The operation detection information can be used by some of the search functions of the network disk recorder manufactured by us. For details of the functions and settings, refer to the instruction manual of the connected device.

## Multisensor camera

Alarm    **VMD area**    SCD area    Notification



Cam. 1 ▾

Area	1(White)	2(Blue)	3(Green)	4(Red)
Status	<input type="radio"/> On <input checked="" type="radio"/> Off	<input type="radio"/> On <input checked="" type="radio"/> Off	<input type="radio"/> On <input checked="" type="radio"/> Off	<input type="radio"/> On <input checked="" type="radio"/> Off
Detection area				
Detection sensitivity				
Delete	<input type="button" value="Delete"/>	<input type="button" value="Delete"/>	<input type="button" value="Delete"/>	<input type="button" value="Delete"/>
Light detection control	<input type="radio"/> On	<input checked="" type="radio"/> Off		
Area No. notification	<a href="#">TCP alarm notification &gt;&gt;</a>			

\* When notifying alarm area numbers by the TCP alarm notification, set "Additional alarm data" to "On".  
\* Various functions working with VMD alarm do not work while this page is open. After setting, close this page.

VMD information addition

Information addition     On     Off

## Camera selection

Select the camera to set the area from each camera.

#### Area

When the motion detection area is selected in the image, it is set in order from Area 1.

#### Status

Enable/disable operation detection.

- **On:** Operation detection is performed.
- **Off:** Operation detection is not performed.

#### Detection area

Set the area of the slider bar to detect movement of the subject in the motion detection area. The smaller the set value, the smaller the movement of the subject is detected. The current setting (1 to 10) is displayed to the right of the slider bar.

#### Detection sensitivity

Use the slider bar to set the sensitivity for detecting movement in the area. Individual settings can be made for each area. The larger the set value, the easier it is to sense the movement.

The current setting (1 (Low) to 15 (High)) is displayed under the slider bar.

#### Delete button

Click the area button to delete the area frame.

### Light detection control

Use the **On** and **Off** buttons to specify whether or not the operation is not detected due to changes in the illumination.

#### NOTE!

- If the lighting intensity is small, it may be impossible to suppress it.
- When the illumination detection suppression is set to **On** and the subject with movement throughout the screen is detected, the operation detection may not be performed.

### Area No. notification

Clicking **TCP alarm notification setup** displays the **Notification** tabs on the Alarm Page.

→[Configuring alarms, p. 258](#)

### VMD information addition

#### Information addition

Sets whether to send the superimposed image data by **On** or **Off** by adding motion detection data to the image. The operation detection information can be used by some of the search functions of the

network disk recorder manufactured by us. For details of the functions and settings, refer to the instruction manual of the connected device.

## Defining VMD areas for motion detection

Set the motion detection area.

**CAUTION!** All alarms are not detected while the setting is being changed on the setting screen. Close the setting screen after setting is completed.

## Detailed settings





### Working with alarms

1. When you drag the mouse on the image and specify an area, the specified area is set to Area 1 (White) and a frame is displayed.

Areas are set from the first to the first area number. The color next to the area number indicates the corresponding color of the frame. In addition, the frame **Status** to be set for the area becomes **On**.

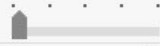
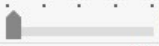
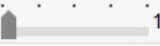
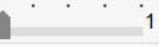
Alarm**VMD area**SCD areaAudio detectionNotification



except the preset positions					All areas
Area	1(White) <span style="color: white;">□</span>	2(Blue) <span style="color: blue;">■</span>	3(Green) <span style="color: green;">■</span>	4(Red) <span style="color: red;">■</span>	
Status	<input checked="" type="radio"/> On <input type="radio"/> Off	<input type="radio"/> On <input type="radio"/> Off	<input type="radio"/> On <input type="radio"/> Off	<input type="radio"/> On <input type="radio"/> Off	
Detection area					
Detection sensitivity					
Delete	<span style="background-color: black; color: white; padding: 2px 5px;">Delete</span>	<span style="background-color: black; color: white; padding: 2px 5px;">Delete</span>	<span style="background-color: black; color: white; padding: 2px 5px;">Delete</span>	<span style="background-color: black; color: white; padding: 2px 5px;">Delete</span>	
Light detection control	<input type="radio"/> On <input checked="" type="radio"/> Off				
Area No. notification	<a href="#">TCP alarm notification &gt;&gt;</a>				

\* When notifying alarm area numbers by the TCP alarm notification, set "Additional alarm data" to "On".

\* Various functions working with VMD alarm do not work while this page is open. After setting, close this page.

SetBack



2. Set the **Detection areaDetection sensitivity** with the slider bar. See below for **Detection areaDetection sensitivity**.

→[Configuring motion detection using VMD areas, p. 271](#)

The area displayed and the movement detection status at the detection sensitivity are displayed in **Detection area**. Modify areas and **Detection areaDetection sensitivity** as required.

3. When you are finished, press **Set**.

**NOTE!** If you do not press the **Set** button, the settings will not be confirmed.

4. To disable the motion detection area, change the **Status** of the area in question to **Off** and click **Set**. The disabled box will be dotted.

When disabled, no alarm is generated even if there is a change in the area.

5. To delete an area for motion detection, click **Delete** in the area to delete to delete the area frame.

6. When **Set** is clicked, the settings are reflected in the camera.

## Configuring screen change detection using SCD areas

This section sets the *Screen Change Detection* (SCD) function.

The screen change detection function activates an alarm when the camera detects a change in the subject by covering the camera with a cloth or a lid or changing the orientation of the camera significantly.

You can set up one area. When the screen contents change in the defined area, an alarm is activated.

**CAUTION!** The screen change detection function cannot be used to prevent theft, fire, etc. We will not be liable for any accident or damage.

#### NOTE!

- In the following cases, the undesired signal detection function will not work for a while.
  - After turning on the power.
  - After changing the screen change detection setting.
  - When the image angle of the machine changes.
- When a disturbance is detected using the screen change detection function, **Alarm notification** is displayed for confirmation.
- →[About live image pages, p. 44](#)
- **Alarm notification** is also displayed when an alarm input is received with a terminal alarm or other alarm such as an operation detection alarm is generated.
- If you change the **Image capture mode** of the **Image** after you set up the screen change detection area, the screen change detection area may be misaligned. Be sure to reconfirm the settings of the screen change detection area.
- In the following cases, screen change detection may not be detected. If only part of the screen is covered or transparent
  - When the camera is oriented in a similar manner before and after the camera.
  - If a privacy zone is set.
- If the **Detection Time** setting of the screen change detection function is shorter than the **Dwell time** setting of the **Black-and-white switching**, the screen change detection alarm may be generated when the color image and black-and-white image are switched. The **Detection Time** setting of the screen change detection function can be improved by making it longer than the **Dwell time** of **Black/ white switching**.
- When the color of the image is close to monochrome, it is difficult to detect disturbance. If screen change detection is difficult, increase the **Detection sensitivity** setting of the screen change detection function or increase the area of the screen change detection function.

## Camera selection

Select the camera to set the area from each camera.

#### NOTE!

<Multisensor>: **Camera selection** can be selected only for Multisensor cameras.

## Area

Set the screen change detection area in the image.

## All areas

Click this button to set the entire area as a screen change detection area.

## Status

Use the **On** and **Off** buttons to specify whether or not to perform screen change detection.

- **On:** Detects disturbance.
- **Off:** No screen change detection is performed.

## Detection area

Set the area for detecting movement of the subject in the screen change detection area to **Small**, **Middle** and **Large**.

## Detection sensitivity

The sensitivities for detection of disturbance in the area are set from **Very Low**, **Low**, **Middle**, and **High**.

## Detection Time

Sets the time from when the subject changes to when the screen change detection alarm is activated. The alarm does not operate when the subject changes only within the set time.

**Delete** button: Click to delete the area frame.

## SCD information addition

### Information addition

Set **On** and **Off** to send superimposed image data by adding screen change detection data to the image.

#### **NOTE!**

Additional screen change detection information is not used by our network disk recorders.

## Defining SCD areas for screen change detection

Set the screen change detection area.

**CAUTION!** No alarms will be detected while these setting are changed.

## Detailed settings

### Working with alarms

1. Select the camera from which the area is to be set by **Camera selection**.

**NOTE!** <Multisensor>: **Camera selection** can be selected only for Multisensor cameras.

When you drag the mouse on the image and specify an area, the specified area is set to the area (white) and a frame is displayed. In addition, **Status** becomes **On**.

Alarm	VMD area	SCD area	Audio detection	Notification
				
<b>All areas</b>				
Status	<input checked="" type="radio"/> On <input type="radio"/> Off			
Detection area	Middle ▾			
Detection sensitivity	Middle ▾			
Detection time	3s ▾			
Delete	<b>Delete</b>			
<small>* Various functions working with SCD alarm do not work while this page is open. After setting, close this page.</small>				
SCD information addition				
Information addition	<input type="radio"/> On <input checked="" type="radio"/> Off			
<b>Set</b>				

- 2.

3. Set **Detection area**, **Detection sensitivity**, and **Discovery Time**. See the table below for **Detection area****Detection sensitivity**.

→[Configuring screen change detection using SCD areas, p. 281](#)

Modify the area or the **Detection area**/**Detection sensitivity** settings as required.

4. When you have finished setting, press **Set**.

**NOTE!** If you do not press the **Set** button, the settings will not be confirmed.

5. To disable the screen change detection area, change **Status** to **Off** and press **Set**. Click this button to display a dotted line with the disabled frame color. When disabled, no alarm is generated by undesired screen change detection.

6. To delete the screen change detection area, press **Delete**. Click to clear the area frame.

7. When **Set** is clicked, the settings are reflected in the camera.

## Configuring audio detection

Click **Audio detection** on the Alarm page. Refer to the following how to display and operate the **Detailed settings** menu.

→[Accessing the camera settings menu, p. 109](#)

→[Editing the camera settings, p. 111](#)

Here, the sound detection setting is performed.

### NOTE!

- When the sound detection function is used to detect sound, **Alarm generation notification** is displayed so that the sound detection is confirmed.
- **Alarm notification** is also displayed when the alarm input is received with the terminal alarm or when the command alarm is received.
- Depending on the network environment, notification may be delayed.
- The sound detection function is not suitable for applications that require high reliability at all times (systems designed to prevent problems). We will not be liable for any accident or damage.

AlarmVMD areaSCD areaAudio detectionNotification



Audio detection	<input type="radio"/> On <input checked="" type="radio"/> Off
Detection sensitivity	Middle ▾
AI analytics target	<input type="checkbox"/> Gunshot <input type="checkbox"/> Yell
	<input type="checkbox"/> Vehicle horn <input type="checkbox"/> Glass break <input type="checkbox"/> Other

\* Various functions working with Audio detection alarm do not work while this page is open.  
After setting, close this page.

Set

## Audio detection

ON/OFF is used to specify whether or not to perform sound detection.

- **On:** Sound detection is performed.
- **Off:** Sound detection is not performed.

## Detection sensitivity

Select the sensitivity of detection.

### NOTE!

When installing cameras indoors, it is recommended that **Sense Level** be set to **Low**.

## AI analytics target

Select the target for detecting AI tone identification.

- **Gunshot:** Detects gunshot, explosive, shock and bursting sounds.
- **Yell:** It detects human screams and crys.
- **Vehicle horn:** Detects the horn of the car.
- **Glass break:** Detects the cracking of windows.
- **Other:** Detects other sounds than gunshot, screech, horn, or cracking of glasses.

### NOTE!

- In the following cases, the target sound may not be detected.
  - If the duration of the cry/horn/glass break is shorter than 1 second.
  - When the difference between the noise of interest and ambient noise is less than 6 dB.
  - If the rain hits the camera microphone directly.
- When multiple types of target sounds are generated at the same time, only one type of alarm is notified.
- The message ID of the unique alarm notification for AI sound identification is as follows. Used for registering sound identification alarms with a recorder or our video monitoring software.
  - Book: 70
  - Broken glass: 71
  - Horn: 72
  - Shriek: 73
  - Other: 55
- When an alarm notification for AI sound identification is received by a recorder, etc., the alarm cannot be received by a recorder etc. during the alarm mask period.

## Configuring alarm notifications

Click **Notification** on the Alarm page. Refer to the following how to display and operate the **Detailed settings** menu.

→[Accessing the camera settings menu, p. 109](#)

→[Editing the camera settings, p. 111](#)

This is used to set the unique alarm notification and HTTP alarm notification.

## Configuring unique alarm notifications

### Unique alarm notification

#### TCP alarm notification

ON/OFF is used to specify whether or not to perform unique alarm notification in the following cases.

- When an alarm is generated (unique alarm notification destination: **Alarm** field)
- When notifying the remaining capacity of the SD card (unique alarm notifying destination: **Diag.** field)
- When there is insufficient space on the SD card (unique alarm notification destination: **Diag.** field)
- When recognizing an SD card error (Original alarm notification destination: **Diag.** field)
- When writing to SD card is failed (unique alarm notification destination: **Diag.** field)
- Upon expiration of the trial period of the function extension software (original alarm notification destination: **Diag.** field)

**NOTE!** Notification of unique alarms is made in the order from **Notify Party 1** (only when checked in the **Alarm** or **Diag.** field).

#### Additional alarm data

Sets ON/OFF whether the detection area number of the operation detection alarm is notified by the unique alarm.

#### Destination port

Set the receiving port number of the unique alarm notification destination.

Allowed values: 1~65535

The following port numbers cannot be set because they are used by this camera.

20, 21, 22, 23, 25, 42, 53, 67, 68, 69, 80 110, 123, 161, 162, 443, 554, 995, 1883, 8883, 10669, 10670, 59000~61000

**NOTE!**

<Multisensor>: The port numbers 32768 to 49151 cannot be set.

#### Retry times

Set the number of retries when the unique alarm notification cannot be performed.

Allowed values: 0~30



## Destination of notification

### PTZ camera

#### Address 1 ~ Address 8

Set the unique alarm notification destination with IP address or host name. You can set up to 8 notification destinations.

- **Alarm** field: When the checkbox is checked, the alarm will be notified.
- **Diag.** field: When checked, notification of the remaining capacity of the SD card, lack of free space of the SD card, SD card recognition error, SD card write error, and expiration of the trial period of the function extension software are notified.
- **Destination server address** field: Enter the IP address or host name of the notification destination.

Input Characters: One-byte alphanumeric and one-byte symbols: . \_ -

To delete the specified notification destination, press **Delete** for the notification destination to be deleted.

#### Auto track cooperation

ON/OFF is used to set whether or not automatic tracking linkage is set.

When **Auto track cooperation** is set to **On**, alarm notification is executed only when **Alarm Area No.** matches the **Alarm area** number set for auto-tracking alarm. Alarm notification other than the automatic tracking alarm is not performed. When using the Auto Tracking Coordination function, set the alarm area condition in Auto Tracking to **On**.

#### Alarm area No.

Allowed values: 1~4

#### NOTE!

- If you want to enter a hostname for **Destination address**, you must configure the DNS on the **Network** tab of the network page.  
→[Basic network settings, p. 309](#)
- Make sure that the notification destination is set correctly. If the notification destination does not exist, a proprietary alarm notification delay or transmission failure may occur.

### Multisensor camera

#### Address 1 ~ Address 48

Set the unique alarm notification destination with IP address or host name. You can set up to 48 notifications.

## Detailed settings

### Working with alarms

---

- **Alarm** field: When the checkbox is checked, the alarm will be notified.
- **Diag.** field: When checked, notification of the remaining capacity of the SD card, lack of free space of the SD card, SD card recognition error, SD card write error, and expiration of the trial period of the function extension software are notified.
- **Destination server address** field: Enter the IP address or host name of the notification destination.

Input Characters: One-byte alphanumeric and one-byte symbols: . \_ -

To delete the specified notification destination, press **Delete** for the notification destination to be deleted.

### Notification per Camera

ON/OFF is used to specify whether or not to execute the transmission setting by camera. When **Notification per Camera** is set to **On**, **Camera No.** is notified when **Camera No.** matches the number of the camera that generated the operation detection alarm or when **Camera No.** matches the camera number of the clicked live display.

**Camera No.:** Allowed values: 1 to 4

#### NOTE!

<Multisensor>: This item is not displayed when **Image capture mode** is in Quad mode or Panorama mode.

### Notification per VMD area

ON/OFF is used to set whether the operation detection area-specific transmission is set.

When **Notification per VMD area** is set to **On**, alarm notification is executed only when **Alarm Area No.** matches the **Alarm area** number set for the operation detection alarm. Alarm notification other than the operation detection alarm is not performed. When using the operation detection area-specific transmission function, set the alarm area status for operation detection to **On**.

**Alarm area No.:** Allowed values: 1~8

#### NOTE!

- If you want to enter a hostname for **Destination address**, you must configure the DNS on the **Network** tab of the network page.  
→[Basic network settings, p. 309](#)
- Make sure that the notification destination is set correctly. If the notification destination does not exist, a proprietary alarm notification delay or transmission failure may occur.

## Configuring HTTP alarm notifications

### HTTP alarm notification

#### Address 1 ~ Address 5

Set the IP address or host name of the HTTP server that notifies the HTTP alarm. You can set up to 5 notification destinations.

Input Characters: One-byte alphanumeric and one-byte symbols: . \_ -

Examples:

- `http://<IP address>:<port>`
- `http://<host name>:<port>`
- `https://<IP address>:<port>`
- `https://<host name>:<port>`

#### NOTE!

**MULTI\_PTZ** Multisensor camera with integrated Multisensor/PTZ can be set up to Notification Destination 4.

#### Alarm field

When an alarm is generated, the HTTP alarm notification is executed.

**Delete** button: When this button is clicked, all notifications, user names, passwords, and notification data set for the item are deleted.

#### User name

Enter the user name that accesses the HTTP server. Number of characters that can be entered: 0 to 63 characters

Characters that cannot be entered: Double-byte and single-byte symbols " &; ¥

#### Password

Enter the password to access the HTTP server.

- Number of characters that can be entered: 0 to 63 characters
- Characters that cannot be entered: Double-byte and single-byte symbols " &

#### NOTE!

Basic or Digest authentication is performed by an HTTP server authentication request.

#### Notification data

Set the notification content to be added after the HTTP server set to **Address 1 ~ Address 5**. Input Characters: Half mark alphanumeric characters and marks

#### NOTE!

- If the HTTP alarm function is enabled, the authentication information (user name, password) of the HTTP server may be leaked on the network when the alarm is notified to the HTTP server.
- The number of characters to be notified (including **http://**) and **Notification data** is limited to 256 characters.
- Be sure to enter the **Notification data** from the slash (/).
- If an HTTP alarm notification fails, it is listed in the system log.
- If **Notification data** is blank and **Set** is pressed, `/cgi-bin/comarm.cgi? CMD=01` is also set.

#### Example:

- Notification destination: `http://192.168.0.100`
- Notification data: `/cgi-bin/comalarms.cgi?CMD=01`
- HTTP alarm notification sent: `http://192.168.0.100/cgi-bin/-commalm.cgi?CMD=01.`

#### PTZ linkage operation

This is the setting to perform the operation in cooperation with the PTZ camera. The HTTPS URL of the PTZ camera is automatically displayed.

#### Alarm field

When checked, the PTZ camera works in conjunction with the camera.

#### User name

The Multisensor camera administrator user name is automatically displayed.

#### Password

The Multisensor camera administrator password is automatically displayed.

#### Notification data

It is displayed as blank.

#### NOTE!

**MULTI\_PTZ PTZ interlocked operation** can be set only for Multisensor cameras with a Multi-sensor/PTZ integrated camera.

# Managing users

On the **User mng.** (user management) page, authentication registration is performed to restrict users and PCs (IP addresses) that can be accessed from a PC, mobile terminal, or tablet terminal. User-managed pages consist of the **User auth.**, **Host auth.**, **IEEE 802.1X**, and **Data encryption** tabs.

## Configuring user authentication

On the Users Administration page, press the **User auth.** tab. Refer to the following how to display and operate the **Detailed settings** menu.

→[Accessing the camera settings menu, p. 109](#)

→[Editing the camera settings, p. 111](#)

Here, authentication settings are made to restrict users who can access the camera from a PC, mobile terminal, or tablet terminal. Up to 24 users can be registered.

**NOTE!**

If you fail user authentication (authentication error) eight or more times in 30 seconds from a PC with the same IP address, you will not be able to access the machine for a while.

### User auth.

Use **On** and **Off** to set whether to authenticate users.

### Guest User

Select whether to set unregistered users. Selecting **Use** enables you to configure both available and unavailable features for non-user-authenticated users.

### Authentication

Set the authentication method to use for user authentication.

- **Digest or Basic:** Use digest or basic authentication.
- **Digest:** Use digest authentication.
- **Basic:** Use basic authentication.

#### NOTE!

- To ensure security, **Digest** is recommended for **Authentication**. If you use **Digest or Basic** or **Basic**, **User name** and **Password** may leak.
- If you change the **Authentication** setting, close the web browser and re-access it.

## User name registration

At the time of new registration, a new username is registered in **User name**. By clicking ▼ on the **User name registration**, you can check the registered users. Registered users are displayed in **Registered Username [Access level]**. (e.g., **admin 1**)

Clicking Change on the right-hand side displays the selected user **User name** and allows the user to change the password. You can delete the selected users by clicking **Delete**.

## User name (1 to 32 characters)

Enter user name.

- Number of characters that can be entered: 1 to 32 characters
- Characters that cannot be entered: Double-byte and single-byte symbols " &; ¥

#### NOTE!

Enter the registered user name and press **Register** to overwrite the user information.

## Password/Password (8 to 32 characters)

Enter a password.

- Number of characters that can be entered: 8 to 32 characters
- Characters that cannot be entered: Double-byte and single-byte symbols " &

#### NOTE!

- Passwords are case-sensitive.
- Use at least three of the following passwords: uppercase alphabetic characters, lowercase alphabetic characters, numbers, and symbols.
- Configure the password so that it does not contain the user name.

## Access level

Set the user access level from the following.

- **Administrator:** Can perform all operations on this unit.
- **Camera control:** Set the access level to camera control. By operating the function selected in **Access Level** I'll do.
- **Live view:** Set the access level to live image display. Operating the function selected in **Access Level** You can.

## Access Level

Select a function that can be used according to the user's access level (camera control, live image display, unregistered user).

- If **User auth.** is set to *Off* and **Guest User** is set to *Not use*: **Access Level** items cannot be set. In addition, all buttons are displayed in the live picture, but authentication is required for the **Set** button.
- If **User auth.** is set to **Off** and **Guest User** is set to **Use**: You can set the **Guest User** items.
- If **User auth.** is set to **On**: **Guest User** items cannot be set.

### Configure these features:

Feature	Explanation
Live image selection	Right to select the image to be displayed in live picture
Listen to	Setting authority of earpiece voice (heard on PC)
Speak to	Setting authority for voice transmission (speaking from PC)
Image update interval	Right to set the interval for updating the JPEG image
Snapshot	Snapshot operation privileges
Recording and playback (Log display)	Log display operation privileges
Manual recording/ deletion	SD card saving/deletion privilege
Preset	Operation privileges for the preset position movement
Pan/tilt operation	Pan/tilt operation authority
Zoom operation	Zoom operation authority
Focus operation	Focus operation privileges
Automatic mode	Auto mode operation privileges
Brightness	Authority to set brightness
AUX	Aux setting authority
Preset position setting	Operation authority of preset position setting

## Configuring host authentication

On the Users Administration page, press the **Host auth.** tab. Refer to the following how to display and operate the **Detailed settings** menu.

→[Accessing the camera settings menu, p. 109](#)

→[Editing the camera settings, p. 111](#)

This restricts the IP address from which the camera can be accessed.

### Host auth.

On/Off is used to specify whether or not to perform host authentication.

#### NOTE!

- Register the IP addresses of the PCs, and then set **Host auth.** to **On**.
- User authentication is required when user authentication is **On**, regardless of how hosted authentication is configured.

### IP address

Enter the IP address of the PCs that are allowed to access the camera. You cannot enter a host name as an IP address.

#### NOTE!

- If you enter IP Address/Mask Length for the subnet, you can restrict the PC that can be accessed for each subnet. For example, if you enter **192.168.0.1/24** and select **2. Camera control** as the access level, PCs **192.168.0.1** through **192.168.0.254** can access the camera at the **2. Camera control** access level.
- Enter the registered IP address and press **Register** to overwrite the host information.
- If the error message **Set Address** is displayed, the IP address of the PC may not be set correctly. Check the IP address of the PC.
- If you receive an error message **Register the [IP address of the PC used for setting and then set Host auth. to On]**, the IP address of the PC may not be set correctly. Reaffirm the IP address setting of the PC.

### Access level

Select the host access level from the following.

1. Administrator/2. Camera control/3. Live only Please refer to the following for the access level.



→[Configuring user authentication, p. 293](#)

## Host check

Click ▼ on the **Host check** to check the IP addresses of registered hosts.

Hosts are displayed as Registered IP Addresses **Access level**. (e.g. 192.168.0.21 **1**) You can delete the selected hosts (IP addresses) by clicking **Delete**.

## Setting a prioritized stream

### NOTE!

<Multisensor>: The priority stream can be selected only for Multisensor cameras.

On the Users Administration page, press the **System** tab.

→[Accessing the camera settings menu, p. 109](#)

→[Editing the camera settings, p. 111](#)

Here, you can configure a priority stream that delivers images without reducing image quality or image update speed, even if multiple users have access to it at the same time.

User auth.	Host auth.	<b>System</b>	IEEE 802.1X	Data encryption
Priority stream				
Activation	<input type="radio"/> On <input checked="" type="radio"/> Off			
Destination IP address(1)	<input type="text"/>			
Destination IP address(2)	<input type="text"/>			
Stream type	Stream(1) (H.265/2560x1920)			
<input type="button" value="Set"/>				

## Priority stream

### Activation

On/Off determines whether to use priority stream delivery.

### NOTE!

If **Activation** is set to **On**, the number of accessible users might be limited.

#### Destination IP address(1)

Enter the IP address of the first destination.

#### Destination IP address(2)

Enter the IP address of the second destination.

#### Stream type

Select either **Stream(1)** or **Stream(2)**.

- **Stream (1)**: The stream (1) image is delivered.
- **Stream (2)**: The stream (2) image is delivered.

## Configuring IEEE 802.1X

On the Users Admin page, press **IEEE 802.1X**. Refer to the following how to display and operate the **Detailed settings** menu.

→[Accessing the camera settings menu, p. 109](#)

→[Editing the camera settings, p. 111](#)

Here, settings are made for IEEE 802.1X.

This function can be used to build a secure network environment using the authentication LAN switch. For authentication LAN switches, contact your network administrator. The procedure varies depending on the **EAP method**. Follow the procedure below. If **IEEE 802.1X** is **On**, start the setting with **IEEE 802.1X** set to **Off**.

User auth.	Host auth.	IEEE 802.1X	Data encryption
IEEE 802.1X		<input type="radio"/> On <input checked="" type="radio"/> Off	
User name		<input type="text"/>	
Password		<input type="password"/>	
Retype password		<input type="password"/>	
CA Certificate	Certificate install	<input type="button" value="Choose File"/> No file chosen	<input type="button" value="Execute"/>
	Information	not installed	<input type="button" value="Confirm"/> <input type="button" value="Delete"/>
Private key or Client Certificate including private key	Installation	<input type="button" value="Choose File"/> No file chosen	<input type="button" value="Execute"/>
	Password (0 to 30 characters)	<input type="password"/>	
	Install status of private key	not installed	<input type="button" value="Delete"/>
Client Certificate	Installation	<input type="button" value="Choose File"/> No file chosen	<input type="button" value="Execute"/>
	Information	not installed	<input type="button" value="Confirm"/> <input type="button" value="Delete"/>
EAP method		EAP-PEAP ▾	

User name and password are required for EAP-MD5 or EAP-PEAP.  
 User name and installation of private key, client certificate and CA certificate are required for EAP-TLS.  
 PEM(\*.pem) or DER(\*.der) format are supported for CA certificate.  
 PEM(\*.pem) or PFX(\*.pfx) format is supported for client certificate and private key.  
 Input password for private key when private key or certificate of PFX format is encrypted. Leave password blank when not encrypted.

## IEEE 802.1X

Configure on/off whether to perform port authentication by IEEE 802.1X.

## User name

Enter the user name that accesses the authentication LAN switch or the user name registered with the server.

Enter any username if it is not registered on the server.

- Number of characters that can be entered: 1 to 32 characters
- Characters that cannot be entered: Full-pitch and half-pitch alphanumeric characters " &; ¥

## Password/Retype password

Enter the password to access the authentication LAN switch.

## Detailed settings

### Managing users

---

- Number of characters that can be entered: 4 to 32 characters
- Characters that cannot be entered: Full-pitch and half-pitch alphanumeric characters " &

## CA Certificate - Certificate install

Install the root CA certificate. Do not include intermediate CA certificates. Only when **IEEE 802.1X** is **Off** can you install it.

### CA Certificate Specifications

Item	Specifications	Remarks
Data format	PEM format or DER format	Extension pem or der
Maximum number of certificates included in the PEM format	1 piece	
Maximum certificate size	About 10 kB	

---

## CA Certificate - Information

- **Not installed:** Have no certificates installed
- **CA certificate host name:** Displayed when installed.
- **Expired:** Certificate expired.

The **Execute** button enable you to view more information about CA certificates. You can delete a CA certificate by using the **Delete** button.

#### **NOTE!**

Verify that the CA certificate has not expired. If you use an expired certificate, you may not be able to connect to the authentication LAN switch.

## Private key or Client Certificate including private key > Installation

Install a client certificate that contains a private key or private key. Only when **IEEE 802.1X** is **Off** can you install it.

### Specification of Client Certificate with Private Key or Private Key

Item	Specifications	Remarks
Data format	PEM format or PFX format	Extension pem or pfx

---

Key length <b>bit</b>	1024/ 1536/ 2048/ 3072/ 4096
-----------------------	---------------------------------

Maximum number of certificates included in the PEM format	6 pieces
---	----------

Maximum certificate size (including intermediate CA certificates)	About 10 kB
---	-------------

### Private key or Client Certificate including private key > Password(0 to 30 characters)

Enter the password if the private key is encrypted or if the password is set on a PFX client certificate. If it is not encrypted, leave it blank.

- Number of characters that can be entered: 0 to 30 characters

### Private key or Client Certificate including private key > Install status of private key

- Not installed: If not installed
- Installed: If installed

The **Delete** button allow you to delete private keys.

### Client Certificate - Installation

Install the client certificate.

If it is signed by an intermediate CA, install it with the intermediate CA certificate on the client certificate.

Only when **IEEE 802.1X** is **Off** can you install it.

### Client Certificate Specifications

Item	Specifications	Remarks
Data format	PEM format	Extension pem
Maximum number of certificates included in the PEM format	6 pieces	
Maximum certificate size (including intermediate CA certificates)	About 10 kB	

## Client Certificate - Information

- Not installed: Have no certificates installed
- **Host name of the certificate:** Displayed when installed
- **Expired:** Certificate expired

The **Execute** button enable you to view more information about client certificates. You can delete client certificates by using the **Delete** button.

### NOTE!

Make sure the client certificate has not expired. If you use an expired certificate, you may not be able to connect to the authentication LAN switch.

## EAP method

Select the authentication method from **EAP-MD5**, **EAP-PEAP**, and **EAP-TLS**.

### EAP-MD5/EAP-PEAP

1. Select **On** in **IEEE 802.1X**.
2. Select **EAP-MD5** or **EAP-PEAP** in **EAP method**.
3. Enter **User name** and **Password/Retype password** and press **Set**.

### EAP-TLS

1. In the **CA CertificateCertificate install**, click the Select Files button, select the CA certificate, and then click the **Execute** button.  
**Information** displays the host name (Common Name) you specified when creating certificates.
2. Click the File button on the Client Certificate that contains the private key or private key and select the client certificate that contains the private key or private key.
3. Enter **Password** if the private key is encrypted or if the password is set to a PFX-based client certificate. If it is not encrypted, leave it blank.
4. You install by clicking **Execute**.  
**Installed** is displayed on the **Install status of private key**.  
For Client Certificates containing private keys, the **Client CertificateInformation** also displays **Installed**.
5. If you installed a private key in step 2, click the Select Files button on the **Client Certificate**, select the client certificate, and then click the **Execute** button.  
**Information** displays the host name (Common Name) you specified when creating certificates.
6. Select **On** in **IEEE 802.1X** and select **EAP-TLS** in **EAP method**.

7. Enter the user name registered with the server in **User name** and press **Set**.

Enter any username if it is not registered on the server.

You do not need to enter **Password/Retype password**.

#### NOTE!

- To delete individual certificates, set **IEEE 802.1X** to **Off**.
- Confirm that the CA and client certificates have not expired. The port authentication feature may not be available if it is expired.

### Example of CA Certificate Confirmation window

CA Certificate - Confirm		
Common Name	192.168.0.113	
Country	JP	
State	Fukuoka	
Locality	Fukuoka	
Organization	i-Pro	
Organizational Unit	*****	
CRT key	RSA key size	2048bit
	Last modified	2021/09/13 09:50:07

**Close**

### Client Certificate Confirmation Screen example

Client Certificate - Confirm		
Common Name	ca000 rootCA	
Country	JP	
State	Osaka	
Locality		
Organization	Panasonic	
Organizational Unit		

**Close**

#### NOTE!

- If the camera cannot be accessed for some reason after the camera is set to **On** by **IEEE 802.1X**, connect the camera to an unauthenticated switch or port.
- IEEE802.1X will be disabled and the camera will be accessible.
- If the client certificate contains an intermediate CA certificate, the client certificate must be first followed by the order of the intermediate CA certificate.
- When a certificate exceeding 10 kB is installed, no error is displayed during installation, but error may occur during connection.

## Setting up data encryption

On the Users Admin page, press **Data encryption**. Refer to the following how to display and operate the **Detailed settings** menu.

→[Accessing the camera settings menu, p. 109](#)

→[Editing the camera settings, p. 111](#)

Here, the data encryption settings are made.

The data encryption settings for each camera are described below.

### PTZ camera

Click + on the left side of the setting screen to expand the item and display the detailed setting. Click > on the left of each expanded item to return to the previous window.

#### Data encryption (Batch change)

Use **On/Off** to enable/disable encryption.

- **On**: Enable data encryption. Encrypt all streams, all JPEG, and audio **AAC-LC**.
- **Off**: Disables data encryption.

#### Stream, JPEG

**On** and **Off** individually configure whether to enable data encryption for each stream and each JPEG.

#### Encryption password, Retype encryption password

Set the data encryption password.

- Number of characters that can be entered: 4 to 16 characters
- Characters that cannot be entered: Double-byte and single-byte symbols " &



**NOTE!**

- The default password is the **Serial no.** displayed on the **Upgrade** screen of the **Maintenance** tab. Be sure to change the password when using data encryption.
- When setting data encryption to **On**, it is recommended that the total bit rate of the streams be set to 16 Mbps or less.
- When data encryption is set to **On**, images cannot be viewed by browsers. To view the encrypted video, use our compatible equipment.
- Data-encrypted MP4 files and JPEG images cannot be viewed on the browser playback page. Download to the PC and check with the decoding tool.
- If **Data encryption (Batch change)** is **On**, the audio **AAC-LC** is encrypted (**G.726G.711** is not encrypted). To encrypt both video and audio, set **Data encryption (Batch change)** to **On** and set the audio **Audio input encoding format** to **AAC-LC**.
- For encrypted MP4 files and JPEG images, the video can be viewed using a decoding tool.

## Displaying pull-down menus when data encryption is enabled

For streams with data encryption enabled in both the **Live view** pull-down menu and the in-screen pull-down menu <Encrypted> The message is displayed.

### Live view pull-down menu on the live screen

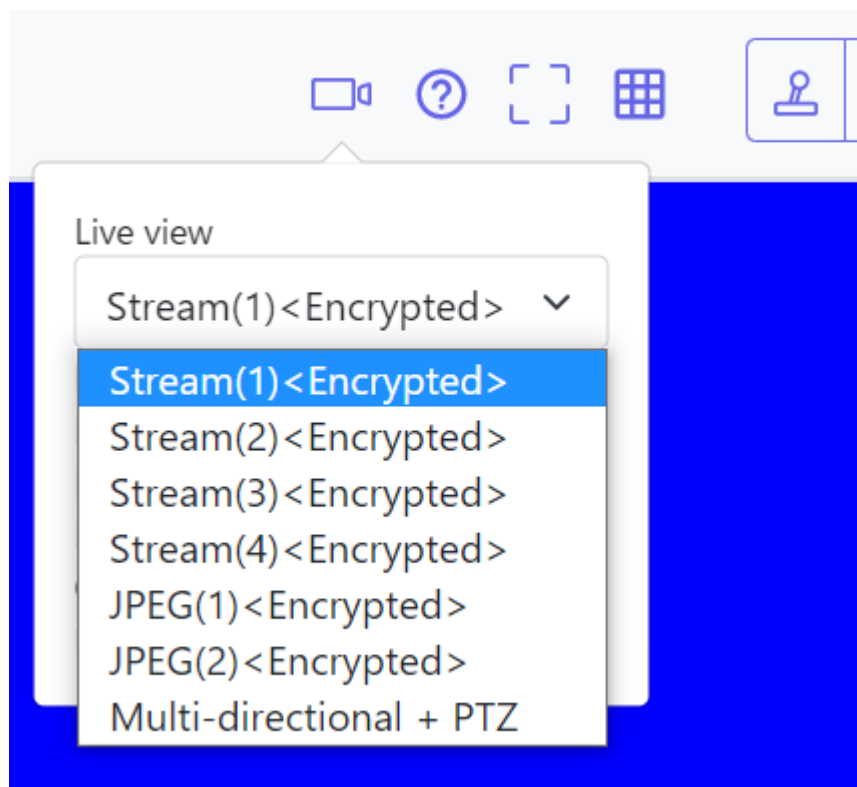

### Live view pull-down menu in the setting window

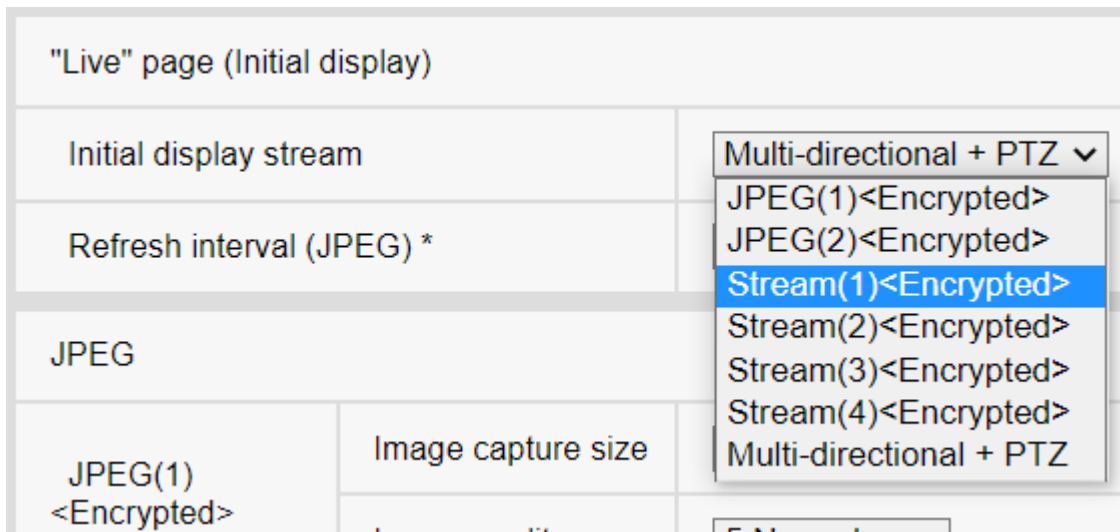

### Multisensor camera

Set the data encryption for each stream separately.

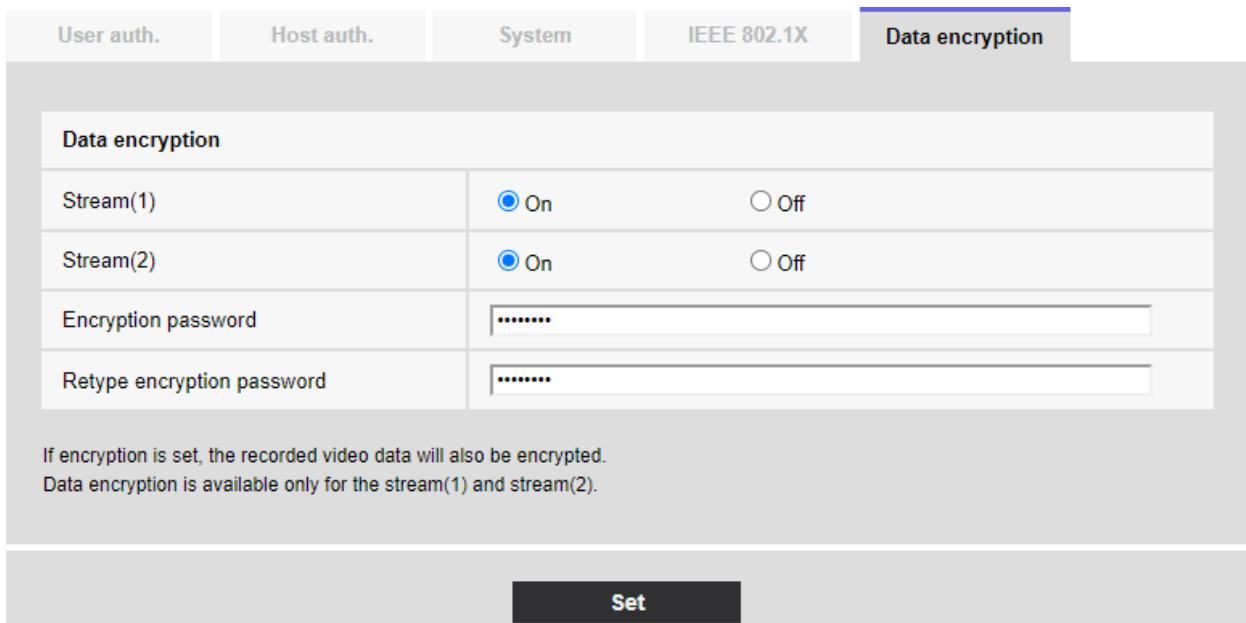

### Stream

Enable/disable data encryption for each stream separately.

### Encryption password, Retype encryption password

Set the data encryption password.

- Number of characters that can be entered: 4~16
- Characters that cannot be entered: Double-byte and single-byte symbols " &

**NOTE!**

- JPEG cannot encrypt data.
- The default password is the **Serial no.** displayed on the **Upgrade** screen of the **Maintenance** tab. Be sure to change the password when using data encryption.
- When setting data encryption to **On**, it is recommended that the total bit rate of the streams be set to 64 Mbps or less.
- The data-encrypted MP4 file cannot be viewed on the browser playback page. Download to the PC and check with the decoding tool.  
→[Playing back images/video streams from the SD card, p. 85](#)
- When the **Data encryption** of all streams is set to **On**, the audio **AAC-LC** is encrypted (**G.726G.711** is not encrypted). If **AAC-LC** is selected in **Audio input encoding format**, the sound will not be played while JPEG is displayed in live picture.
- For encrypted MP4 files, the video can be viewed using the decryption tool.

### Displaying pull-down menus when data encryption is enabled

For streams with data encryption enabled in the **Live view** pull-down menu <Encrypted > The message is displayed. Also, in the pull-down menu in the setting screen, streams with valid data encryption are displayed in <>.

**Live view pull-down menu on the live screen**

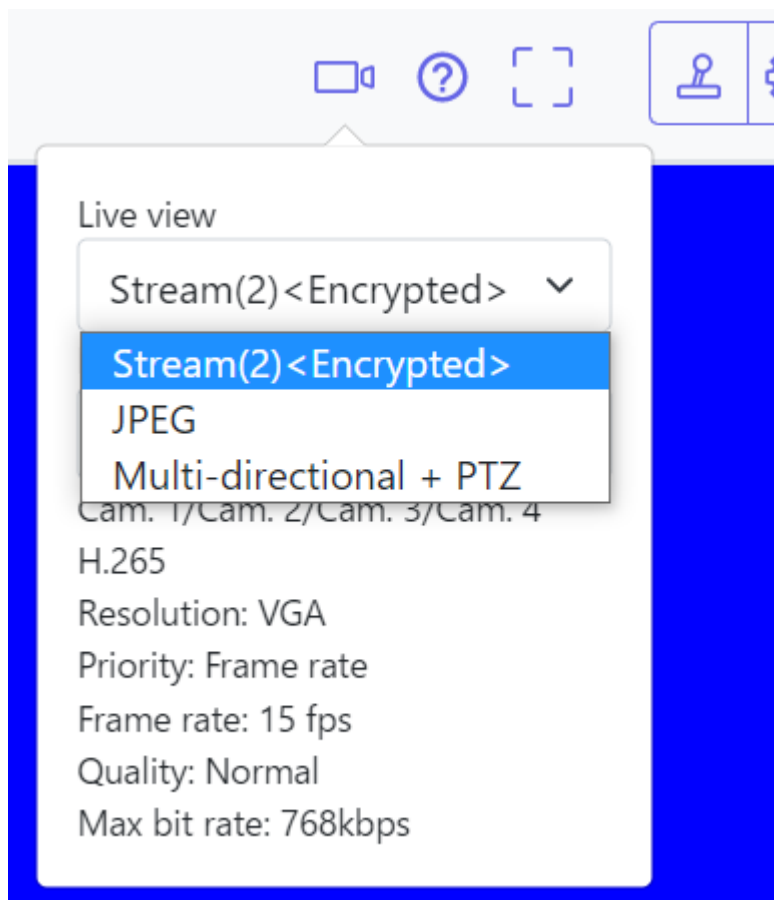

### Live view pull-down menu in the setting window

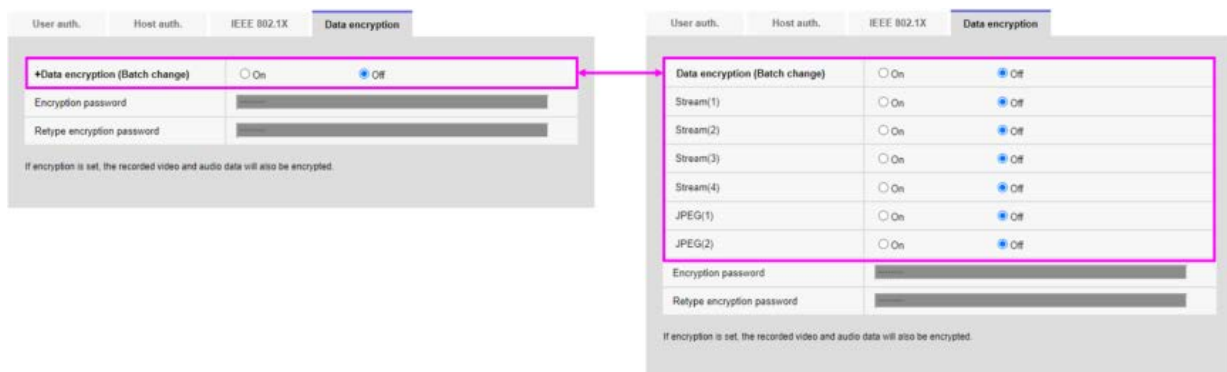
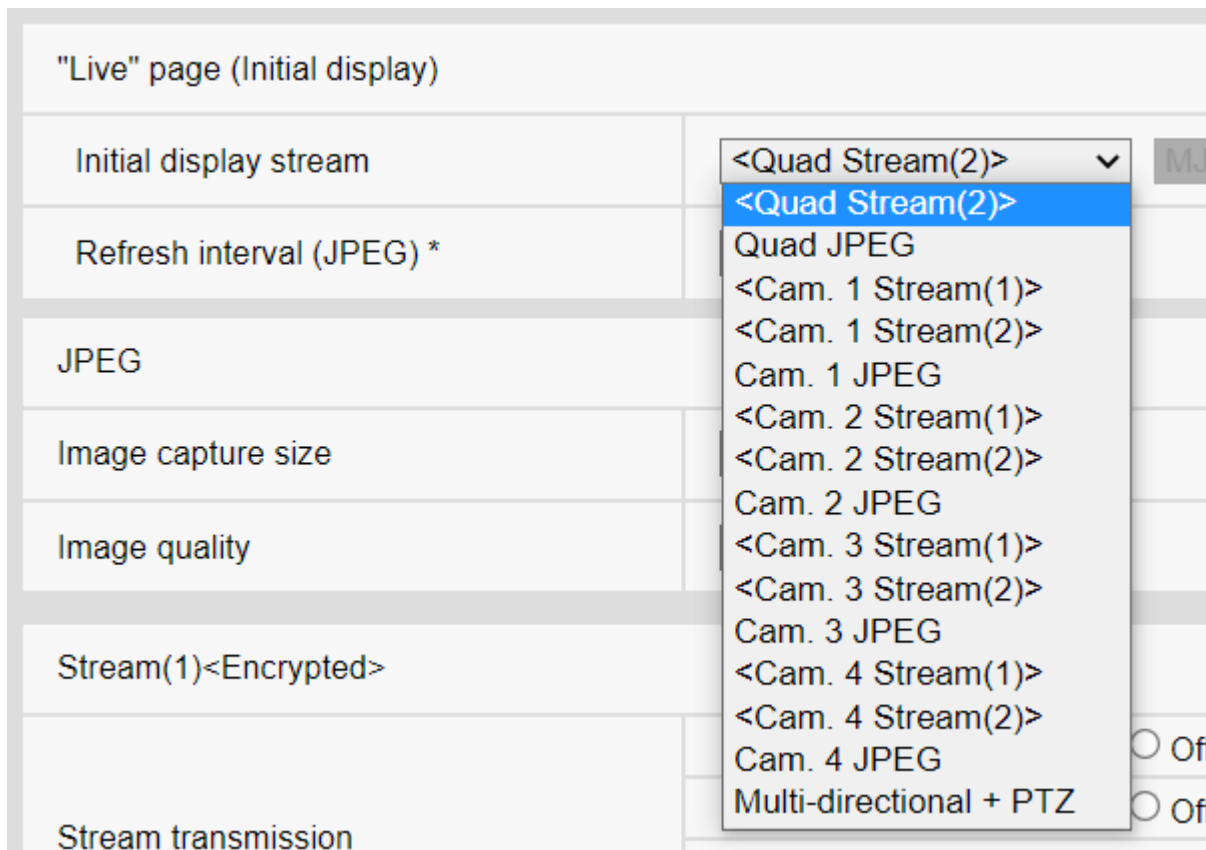

## Configuring the network

### Basic network settings

On the Network Page, press the **Network** tab. Refer to the following how to display and operate the **Detailed settings** menu.

## Detailed settings

### Configuring the network

→Accessing the camera settings menu, p. 109

→Editing the camera settings, p. 111

The following information is required to configure the network. Check with your network administrator or Internet service provider.

- IP address
- Subnet Mask
- Default Gateway (with Gateway Server Router)
- HTTP port
- Primary server address for DNS, secondary server address (when DNS is used)

#### NOTE!

- Contact your network administrator for the address settings for each server.
- To connect a camera to a router and access the camera via the Internet, you must configure a separate HTTP port number for each network camera, and use the router's port forwarding features to translate addresses. For details, refer to your router's instruction manual.
- Port forwarding functions are used to convert global IP addresses to private IP addresses, such as Static IP Mascalade and Network Address Translation (NAT). This feature is configured on the router.

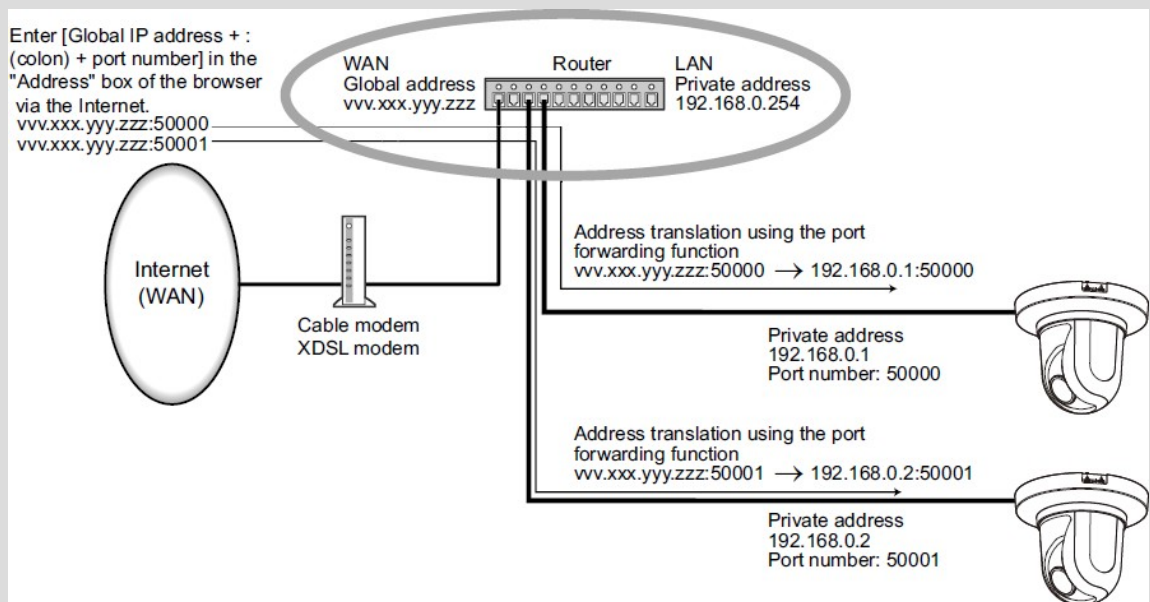

## IPv4 network

### Network Settings

Select how to set the IP address.

- **Static:** Enter the IP address into the **IP address(IPv4)** to set the IP address.
- **DHCP:** Set the IP address using the DHCP function. If you cannot obtain an IP address from the DHCP server, set the IP address to 192.168.0.10. Subsequently, if you obtain an IP address from a DHCP server, you change it to the IP address.
- **Auto(AutoIP):** Set the IP address using the DHCP function. If the DHCP server is not found, the IP address is automatically configured.
- **Auto(Advanced):** Using the DHCP function, refer to the network address information and set the unused IP address to the camera as the fixed IP address. The camera automatically determines the set IP address within the range of the subnet mask. If the DHCP server is not found, set the IP address to 192.168.0.10.

**NOTE!**

- If the IP address cannot be retrieved from the DHCP server in AutoIP, search for the IP address that is not used in the same network between 169.254.1.0 and 169.254.254.255 and set the IP address.
- In DHCP/Auto setting, if the DHCP server is not found, set the IP address of the PTZ camera to 192.168.0.10 and the IP address of the Multisensor camera to 192.168.0.11.

### IP address(IPv4)

When the DHCP function is not used, enter the IP address of the camera. Do not overlap with the IP address set on the PC or other network camera.

**NOTE!**

Multiple IP addresses are not available even when the DHCP function is used. Contact your network administrator for the DHCP server configuration.

### Subnet mask

When the DHCP function is not used, enter the subnet mask of the camera.

### Default gateway

If you do not use the DHCP function, enter the default gateway for your camera.

**NOTE!**

Multiple IP addresses are not available for the default gateway, even if you use the DHCP facility. Contact your network administrator for the DHCP server configuration.

### DNS

Specify whether the DNS server addresses are automatically acquired (**Auto**) or manually entered (**Manual**).

When set to **Manual**, you need to configure the DNS server IP addresses.

## Detailed settings

### Configuring the network

---

If you use DHCP, you can automatically obtain the DNS server address by setting it to **Auto**.

Contact your system administrator for the setting.

#### Primary server address/Secondary server address

If you use **DNS** with **Manual**, enter the IP address of the DNS server. Contact your system administrator for the IP address of the DNS server.

## IPv6 network

**CAUTION!** When IPv6 is accessed, the stream image cannot be displayed on the live screen. If you want to display the stream image on the live screen, please access it via IPv4.

### Manual

Configure **On** and **Off** to manually configure IPv6 addresses.

- **On:** Manually enter the IPv6 address.
- **Off:** IPv6 address cannot be entered manually.

### IP address(IPv6)

If **Manual** is set to **On**, IPv6 addresses must be entered manually. Enter to avoid duplication with other devices.

#### **NOTE!**

When connecting over a router with a manually configured IP address, enable the automatic configuration feature for IPv6 addresses using IPv6-compatible routers. Configure an IPv6 address that contains prefix information provided by IPv6-compatible routers. For details, refer to your router's instruction manual.

### Default gateway

Enter the default gateway for the IPv6 network when the IPv6 network **Manual** is **On**.

### DHCPv6

You can configure **On/Off** to use the IPv6 DHCP feature.

Configure the DHCP server so that the PC and other network cameras that do not use the DHCP function do not have the same IP address. Contact your network administrator for server configuration.

### Primary DNS server address/Secondary DNS server address

Enter the IPv6 address of the DNS server. Contact your system administrator for the IPv6 address of the DNS server.



## Common

### HTTP port

Assign individual port numbers. Configurable port number: 1~65535

The following port numbers cannot be set because they are used by this camera.

20, 21, 22, 23, 25, 42, 53, 67, 68, 69, 80, 110, 123, 161, 162, 443, 554, 995, 1883, 8883, 10669, 10670, 59000~61000

#### NOTE!

- Some ports may not be accessed by some browsers. If access is lost, use HTTPS to change the port number.
- <Multisensor>: The port numbers 32768 to 49151 cannot be set.

### Line speed

Select the data communication speed from the following. Normally, it is recommended to use the default **Auto**.

- **Auto**: The communication speed is set automatically.
- **100 M-Full**: 100 Mbps full duplex
- **100 M-Half**: 100 Mbps half duplex
- **10 M-Full**: 10 Mbps full duplex
- **10 M-Half**: 10 Mbps half duplex

### Max RTP packet size

Set whether to limit the size of RTP packets sent from the camera when viewing camera images using RTP. Normally, it is recommended to use the **1,500 bytes** option.

If the packet size of the communication line is limited, select **Restricted (1280 bytes)**. Contact the network administrator for the maximum packet size of the communication line.

### HTTP max segment size(MSS)

Set whether to limit the maximum segment size (MSS) sent from the camera when viewing the camera image using HTTP. Usually, it is recommended to use the default settings.

If the maximum segment size (MSS) of the communication line to be used is limited, select **1024 Byte/Restricted (1280 Byte)**. Contact your network administrator for the maximum segment size (MSS) of the communication line.

### Bandwidth control(bit rate)

Select the amount of data delivered from the following.

#### NOTE!

- If **64 kbps** is selected, set the **Audio transmission mode** on the **Audio** tab to **Off**.  
→[Configuring audio options, p. 224](#)
- If **Bandwidth control(bit rate)** is set low, the snapshot button may not work depending on the operating environment. If so, select **JPEG** on the live page and run the snapshot with the smallest resolution delivered.
- <Multisensor>: When playing back images stored on the SD card, the **Bandwidth control(bit rate)** must be set to **Unlimited** or above **51200 kbps**.

#### Easy IP Setup accommodate period

Set the time to enable Network Settings from IP-based Simple Configuration Software to either **20min** or **Unlimited** after the camera starts.

- **20 minutes**: The camera setting operation using the IP easy setting software is enabled only for 20 minutes after starting the machine.
- **Unlimited**: The camera setting operation in the IP easy setting software is always enabled.

#### NOTE!

Camera display with the IP easy setting software is always enabled and the camera screen can be opened.

#### FTP access to camera

Select **Allow** or **Forbid** to determine whether to allow or forbid the FTP access to camera.

#### ONVIF®

Use **On/Off** to set whether to use the ONVIF function.

## Advanced network settings

On the Network Page, press the **Advanced** tab.

→[Accessing the camera settings menu, p. 109](#)

→[Editing the camera settings, p. 111](#)

Here, the SMTP (mail), FTP/SFTP, NTP, UPnP, HTTPS, DDNS, SNMP, QoS, SRTP, and MQTT functions are set.

Click on the link of each item to navigate to the corresponding page.

Network

Advanced

[SMTP\(E-mail\)](#) | [FTP/SFTP](#) | [NTP](#) | [UPnP](#) | [HTTPS](#) | [DDNS](#) | [SNMP](#) | [QoS](#) | [SRTP](#) | [MQTT](#)

## Configuring SMTP (E-mail)

### Email notification

On/Off is used to specify whether to send mail in the following cases.

- When an alarm is activated (email to **Alarm** field).
- Remaining SD card capacity notification (all destinations with **Diag.** checkbox checked).
- SD card running out of space (all destinations with **Diag.** checkbox checked).
- SD card recognition/failure errors (all destinations with **Diag.** checkbox checked).

### Alarm image attachment

**On/Off** sets whether or not to attach images when sending mail by alarm detection.

### Image capture size

Select the resolution of the image to be attached to the alarm mail from the following. JPEG(1)/JPEG(2)

### SMTP server address

Enter the IP address or host name of the SMTP server to send email.

- Number of characters that can be entered: 1 to 128 characters
- Input Characters: One-byte alphanumeric and one-byte symbols: . \_ -

### SMTP port

Enter the port number to send mail. Configurable port number: 1~65535

The following port numbers cannot be set because they are used by this camera.

20, 21, 22, 23, 42, 53, 67, 68, 69, 80, 110, 123, 161, 162, 443, 554, 995, 1883, 8883, 10669, 10670, 59000~61000

### POP server address

If you selected **POP before SMTP** in **Type**, enter the IP address or hostname of the POP server.

- Number of characters that can be entered: 1 to 128 characters
- Input Characters: One-byte alphanumeric and one-byte symbols: . \_ -

#### NOTE!

- To enter a hostname for **SMTP server address/POP server address**, you must configure the DNS on the **Network** tab of the network page.  
→[Basic network settings, p. 309](#)
- <Multisensor>: The port numbers 32768 to 49151 cannot be set.

## Authentication

### Type

Select the authentication method for sending mail from the list below.

- **None:** Without authentication
- **POP before SMTP:** Prior to sending email, authenticate the POP server that receives the email.
- **SMTP:** Authenticate the SMTP server.

#### NOTE!

If you do not know how to authenticate email, contact your network administrator.

### User Name

Enter the username that you want to access the server.

- Number of characters that can be entered: 0 to 32 characters
- Characters that cannot be entered: Double-byte and single-byte symbols " &; ¥

### Password

Enter the password to access the server.

- Number of characters that can be entered: 0 to 128 characters
- Characters that cannot be entered: Double-byte and single-byte symbols " &

## Sender's E-mail address

Enter the sender's e-mail address. The e-mail address is displayed in the *From* field of the received mail.

- Number of characters that can be entered: 3 to 128 characters
- Input Characters: Half-pitch alphanumeric and half-pitch symbols @. \_ -

## SSL

When sending **Alarm Notification** or **Diag.** mail notification in SSL-encrypted format, set it to **On**.

When set to **On**, the authentication method is set to **SMTP**. Configure the **User name** and **Password**

for authentication.

**NOTE!**

- Some SMTP servers may not support SSL.
- The SMTP over SSL method is supported. STARTTLS is not supported.
- If set to **On**, you may need to set the SMTP port number to 465. Check with your provider for details.

## Address 1 through 4

Set the mail address of the notification destination. You can set up to 4 notification destinations.

- Number of characters that can be entered: 3 to 128 characters
- Input Characters: Half-pitch alphanumeric and half-pitch symbols @. \_ -
- Press **Delete** to delete an email address.

## Notification options of addresses 1 through 4

Activate one or more of these options to send an e-mail:

- **Terminal *n***: When an alarm is generated at terminal *n* ( $n = 1 \sim 3$ ).
- **VMD**: When operation is detected.
- **SCD**: When screen change detection occurs.
- **Command Alarm**: When a command alarm is entered.
- **Audio detection**: When sound is detected.
- **Diag.:**
  - SD card Remaining capacity notification
  - SD card with insufficient free space
  - SD card recognition error
- **Auto track**: When an automatic tracking alarm is generated.

**NOTE!**

The diagnostic mail notified when the **Diag.** field is checked does not use the **Email subject** and **Email body** settings set below.

## E-mail subject (Alarm)

Enter the subject of an alarm e-mail.

- Number of characters that can be entered: 0 to 50 characters
- **Use the camera title**: The camera title is displayed in the mail subject line.

- **Cause of alarm:** Add an alarm factor to the email subject.

### E-mail subject (Diag.)

Enter the subject of a diagnosis e-mail.

Number of characters that can be entered: 0 to 50 characters

Use the camera title: The camera title is displayed in the mail subject line.

### E-mail body (Alarm)

Enter the body of the alarm message.

- Number of characters that can be entered: 0 to 200 characters

### 1: Cause of alarm

The alarm cause %p% is added to the message body, where %p% can be one of the following:

- "VMD": VMD alarm
- "SCD": SCD alarm
- "AT": auto-tracking alarm
- AI-VMD alarms:
  - "INT": Intrusion alarm
  - "LOI": Loitering alarm
  - "DIR": Wrong direction alarm
  - "CLD": Line-crossing alarm
- For the terminal alarm: The terminal names set in **Terminal name > Terminal n**. For example, the name of Terminal 1 could be "Back door opened".
- "CMD": command alarm
- Sound detection alarms (AI sound identification targets):
  - "Audio detection gunshot": gunshot alarm
  - "Audio detection yell": human yell alarm
  - "Audio detection Vehicle Horn": vehicle horn honking alarm
  - "Audio detection Glass break": glass breaking alarm
  - "Audio detection": Other sounds alarm

**NOTE!**

- <Multisensor>: In the case of SCD/VMD alarms, the camera automatically adds the camera channel. For example: "VMD(CH3)" for a VMD alarm of camera 3.
- If the SD card has no free space, **SD card is FULL** or **SD card cannot be recognized** is sent.

**Occurrence time**

The occurrence time %t% is added to the message text, where %t% is replaced by the time the alarm occurred (hour: minute: second).

**Terminal name**

**Terminal *n* (Up to 10 characters)**

Enter the name of Terminal *n* used for alarm information.

**Mail notification example**

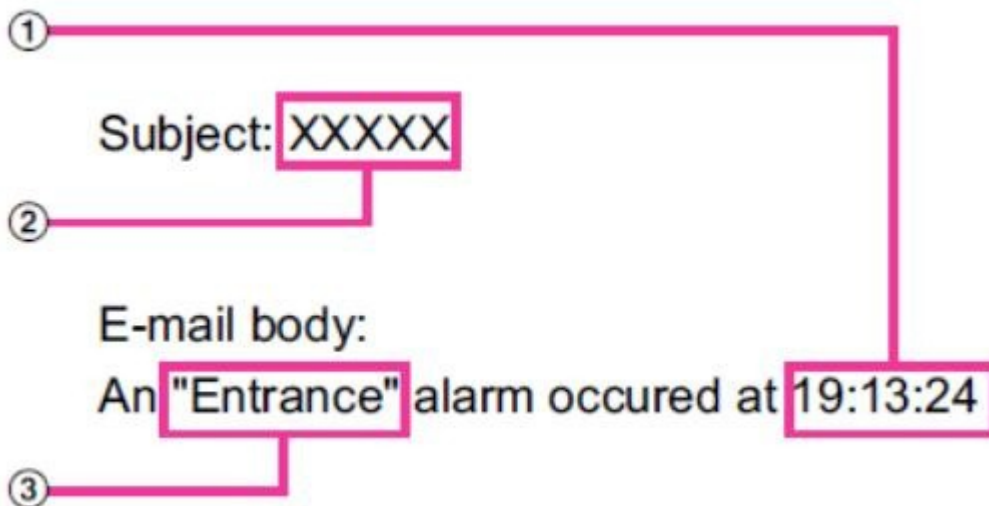

- Alarm time in e-mail body.
- Camera title used as e-mail subject.
- Terminal name as set for the corresponding terminal in e-mail body.

**Configuring FTP/SFTP transmission function**

FTP (File Transfer Protocol) and SFTP (SSH File Transfer Protocol) are file transfer protocols used to send images to servers.

SFTP can safely send images to the server using an SSH (Secure Shell) encrypted data stream. The following two transmission functions are available.

## Detailed settings

### Configuring the network

---

- Image sent when alarm is generated
- Transmit images periodically



Network		Advanced	
<a href="#">SMTP(E-mail)</a>   <a href="#">FTP/SFTP</a>   <a href="#">NTP</a>   <a href="#">UPnP</a>   <a href="#">HTTPS</a>   <a href="#">DDNS</a>   <a href="#">SNMP</a>   <a href="#">QoS</a>   <a href="#">SRTP</a>   <a href="#">MQTT</a>			
Transmission protocol	<input type="radio"/> FTP <input checked="" type="radio"/> SFTP		
Alarm setting			
Alarm image transmission	<input type="radio"/> On <input checked="" type="radio"/> Off		
Directory name	<input type="text"/>		
File name	<input type="text"/> <input checked="" type="checkbox"/> Terminal 1 <input checked="" type="checkbox"/> Terminal 2 <input checked="" type="checkbox"/> Terminal 3 <input checked="" type="checkbox"/> VMD <input checked="" type="checkbox"/> SCD <input checked="" type="checkbox"/> Auto track <input checked="" type="checkbox"/> Command alarm <input checked="" type="checkbox"/> Audio detection <small>* For alarms by the "Ext. software", alarm images will be transmitted only by configuring the alarm image SFTP transmission.</small>		
FTP transmission retry	<input type="radio"/> On <input checked="" type="radio"/> Off		
Pre alarm	Transmission interval 1fps	Maximum number of images 0 pic	Recording duration 0s
Post alarm	Transmission interval 1fps	Number of images 100 pics	Recording duration 100s
Image capture size	<input type="text"/> <JPEG(2)> (640x360)		
Periodic transmission settings			
Periodic image transmission	<input type="radio"/> On <input checked="" type="radio"/> Off		
Directory name	<input type="text"/>		
File name	<input type="text"/> <input checked="" type="radio"/> Name w/time&date <input type="radio"/> Name w/o time&date		
Transmission interval	<input type="text"/> 1s		
Image capture size	<input type="text"/> <JPEG(2)> (640x360)		
SFTP server setting			
SFTP server address	<input type="text"/> <small>Example of entry: 192.168.0.10</small>		
Port number	<input type="text"/> 22 (1-65535)		
Host key hash	SHA256: <input type="text"/> <small>Example of entry: dqVcdVZ/2ySO5tz/R6YR+rpbW6dnap6P743uiMV0cf0</small>		
User name	<input type="text"/>		
Password	<input type="password"/>		
FTP server setting			
FTP server address	<input type="text"/> <small>Example of entry: 192.168.0.10</small>		
User name	<input type="text"/>		
Password	<input type="password"/>		
Control port	<input type="text"/> 21 (1-65535)		
FTP mode	<input checked="" type="radio"/> Passive <input type="radio"/> Active		

## Transmission protocol

Configure the protocol with the destination server by selecting it from FTP/SFTP.

- SFTP: Use SFTP as the protocol for communicating with the server.
- FTP: Use FTP as the protocol to communicate with the server.

**CAUTION!** If FTP is selected in the protocol setting, FTP server authentication information (user name, password) may be leaked on the network when sending images to the FTP server. Use of SFTP is recommended.

## Alarm setting

### Alarm image transmission

Set to **On** to send images to the corresponding server.

### Directory name

Enter the name of the folder where you want to save the image file.

For example, if you want to specify the ALARM folder under the server root folder, enter **/ALARM**.

- Number of characters that can be entered: 1 to 256 characters
- Characters that cannot be entered: Double-byte and single-byte symbols " &;

### File name

Enter the file name to send the image to the server. The following file names are actually saved.

- File name: File name entered + Date and time (year, month, day, minute, second) + Sequence number
- Number of characters that can be entered: 1 to 32 characters
- Characters that cannot be entered: Double-byte and single-byte symbols " & \* /; < > ? ¥ |

If **Alarm image transmission** is **On**, select the alarm type to send an alarm image:

- **Terminal *n***: Terminal *n* alarm detected.
- **VMD**: VMD alarm detected.
- **SCD**: SCD alarm detected.
- **Auto track**: Auto-track alarm detected.
- **Audio detection**: Audio detection alarm detected.
- **Command alarm**: Command alarm detected.

### FTP transmission retry

Select **On/Off** to retransmit if FTP transmission fails.

- **On:** If forwarding fails, retransmission is performed until the forwarding is successful.
- **Off:** If the transfer fails, the image is discarded and the next image is sent.

**NOTE!**

If **Transmission protocol** is set to SFTP, **FTP transmission retry** cannot be set.

## Pre alarm

### Transmission interval

Select the image update interval before alarm from the following.

### Maximum number of images

Select the number of images to send.

### Recording duration

The set **Transmission interval** and **Maximum number of images** indicate the recording time of the images prior to the alarm.

**NOTE!**

- When JPEG (1) is set to the resolution of the image to be sent, the pre-alarm cannot be set if the resolution of JPEG (1) is larger than **1920x1080**.
- When the image quality control at alarm is set to **On**, only the post alarm is recorded and the image quality at alarm is set. This does not apply to pre-alarm recording.
- Maximum number of images that can be sent in a pre-alarm:

Resolution	Image quality									
	0	1	2	3	4	5	6	7	8	9
1280x960	5	6	7	8	10	10	10	20	30	40
1280x720	7	8	10	10	10	20	20	30	40	50
VGA	10	20	20	30	30	40	50	50	40	50
640x360	20	30	40	50	50	50	50	50	50	50
QVGA	40	50	50	50	50	50	50	50	50	50
320x180	50	50	50	50	50	50	50	50	50	50

## Post alarm

### Transmission interval

Select the transmission interval to send the alarm image.

## Detailed settings

### Configuring the network

---

#### Number of images

Select the number of images to send.

#### Recording duration

The **Transmission interval** you set shows how long it takes to save the set **Number of images**.

#### Image capture size

Select the resolution of the image to be sent when an alarm is generated from the following. JPEG (1)/JPEG(2)

### Periodic transmission settings

#### Periodic image transmission

Use the **On** and **Off** buttons to specify whether or not to perform periodic transmissions.

##### NOTE!

If you use periodic transmission, you need to schedule FTP/SFTP periodic transmission on the **Schedule** tab of the Schedule page.

→[Configuring periodic FTP/SFTP recordings, p. 145](#)[Periodic Transmission Setting Screen](#)

#### Directory name

Enter the name of the folder where you want to save the image file to be sent.

For example, if you want to specify the img folder under the root folder of the server, enter **/img**.

Number of characters that can be entered: 1 to 256 characters

Characters that cannot be entered: Double-byte and single-byte symbols " &;

#### File name

Enter the image file name to be sent and select the file name format from the following.

- **Name w/time&date:** File name + transmission date and time (year, month, day, minute, second) + 00 is used as the file name.
- **Name w/o time&date:** Use the entered file name as is and overwrite the file on the server every time.
- Number of characters that can be entered: 1 to 32 characters
- Characters that cannot be entered: Double-byte and single-byte symbols " &; / \* < > ? ¥ |

##### NOTE!

If **Name w/time&date** is selected, during Daylight Saving Time, "s" is added to the file name after **File name entered + Transmission date and time (year/month/ day/minute/second) + 00**.

#### Transmission interval

Select the transmit interval.

---

## Image capture size

Select the resolution of the image file to send.

## SFTP server setting

**NOTE!** If **Transmission protocol** is set to FTP, you cannot configure the SFTP server.

### SFTP server address

Enter the IP address or host name of the SFTP server that sends the image.

- Number of characters that can be entered: 1 to 128 characters
- Input Characters: One-byte alphanumeric and one-byte symbols: . \_ -

### CAUTION!

If you want to enter a hostname for **SFTP server address**, you must configure the DNS on the **Network** tab of the network page.

→[Basic network settings, p. 309](#)

### Port number

Enter the control port number of the SFTP server. Configurable port number: 1~65535

The following port numbers cannot be set because they are used by this camera.

20, 21, 22, 23, 25, 42, 53, 67, 68, 69, 80, 110, 123, 161, 162, 443, 554, 995, 1883, 8883, 10669, 10670, 59000~61000

### NOTE!

<Multisensor>: The port numbers 32768 to 49151 cannot be set.

### Host key hash

Enter the hash value for the public key of the SFTP server.

Number of characters that can be entered: 43 to 44 characters

Input Characters: Half-pitch alphanumeric and half-pitch symbols + / =

### User name

Enter the user name (login name) to access the SFTP server.

- Number of characters that can be entered: 1 to 32 characters
- Characters that cannot be entered: Double-byte and single-byte symbols " &; ¥

### Password

Enter the password to access the SFTP server.

## Detailed settings

### Configuring the network

---

- Number of characters that can be entered: 0 to 32 characters
- Characters that cannot be entered: Double-byte and single-byte symbols " &

## FTP server setting

**NOTE!** If **Transmission protocol** is set to SFTP, you cannot configure the FTP server.

### FTP server address

Enter the IP address or host name of the FTP server that sends the image.

- Number of characters that can be entered: 1 to 128 characters
- Input Characters: One-byte alphanumeric and one-byte symbols: . \_ -

#### **NOTE!**

If you want to enter a hostname for **FTP server address**, you must configure the DNS on the **Network** tab of the network page.

→[Basic network settings, p. 309](#)

### User name

Enter the user name (login name) to access the FTP server.

- Number of characters that can be entered: 1 to 32 characters
- Characters that cannot be entered: Double-byte and single-byte symbols " &; ¥

### Password

Enter the password to access the FTP server.

- Number of characters that can be entered: 0 to 32 characters
- Characters that cannot be entered: Double-byte and single-byte symbols " &

### Control port

Enter the control port number of the FTP server. Configurable port number: 1~65535

The following port numbers cannot be set because they are used by this camera.

20, 21, 22, 23, 25, 42, 53, 67, 68, 69, 80 110, 123, 161, 162, 443, 554, 995, 1883, 8883, 10669, 10670, 59000~61000

#### **NOTE!**

<Multisensor>: The port numbers 32768 to 49151 cannot be set.

### Recording priority

Select FTP communication mode from Passive mode/Active mode. Normally, select **Passive**. If you cannot connect with **Passive**, switch to **Active**.

## Configuring NTP

This section configures the NTP server, including the address and port number of the NTP server.

**NOTE!** If you need to set the time more accurately in system operation, use the NTP server.

### Time adjustment

Select the time adjustment method from the following. The time adjusted in the selected manner is used as the standard time of the machine.

- **Manual:** The time set in the **Basic** tab on the base page is used as the standard time of the camera.
- **Synchronize to NTP Server:** The time automatically adjusted in synchronization with the NTP server is used as the standard time of the machine.

### NTP server address setting

If you selected **Synchronization with NTP server** in **Time adjustment**, enter the NTP server address.

- **Auto:** Get the NTP server address from the DHCP server.
- **Manual:** Enter the NTP server address into the **NTP server address** to configure the NTP server address.

**NOTE!**

To obtain **NTP server address** from a DHCP server, you must set **Network Settings** to DHCP or AutoIP on the **Network** tab of the network page.

→[Basic network settings, p. 309](#)

### NTP server address

If you selected **Manual** in **NTP server address setting**, enter the IP address or hostname of the NTP server.

- Number of characters that can be entered: 1 to 128 characters
- Input Characters: One-byte alphanumeric and one-byte symbols: . \_ -

**NOTE!**

To enter a hostname for **NTP server address**, you must configure the DNS on the **Network** tab of the network page.

→[Basic network settings, p. 309](#)

#### NTP port

Enter the port number of the NTP server. Configurable port number: 1~65535

The following port numbers cannot be set because they are used by this camera.

20, 21, 22, 23, 25, 42, 53, 67, 68, 69, 80, 110, 123, 161, 162, 443, 554, 995, 1883, 8883, 10669, 10670, 59000~61000

#### NOTE!

<Multisensor>: The port numbers 32768 to 49151 cannot be set.

#### Time adjustment interval

Select the interval (in 1-24 hour increments) at which the time is to be acquired from the NTP server.

#### NTP test

Select **Synchronization with NTP server** for **Time adjustment**, set up the NTP server, and then press **Execute**. You can communicate with the NTP server, perform time synchronization, and check the NTP operation.

#### NOTE!

- When the NTP test is successful, the **The NTP time correction completed successfully.** is displayed.
- If the NTP test fails, the **The NTP time correction failed.** is displayed.
- If **Time adjustment** is set to **Manual**, the **Execute** button for NTP tests will be grayed out.
- If **Time adjustment** is set to **Synchronization with NTP server** and the NTP server address is not set, the **Execute** button for the NTP tests are grayed out.



## Configuring UPnP

### NOTE!

- When UPnP is set to ON and access via the Internet is set to **Multisensor + PTZ by Live view**, only the image of the accessed camera is displayed.
- This machine supports UPnP (Universal Plug and Play). The UPnP function enables you to set the following settings automatically.
  - Configure the port forwarding function for routers. However, a UPnP-enabled router is required. This setting is useful for accessing the camera from the Internet or from a mobile or tablet terminal.
  - Create a shortcut to the camera in the **Network** folder of the PC and update the shortcut automatically even if the camera has changed IP addresses.

## Auto port forwarding

Configure on/off whether to use the router's port forwarding function.

### NOTE!

- To use the Automatic Port Forwarding feature, the router you use must be UPnP-enabled and UPnP enabled.
- Automatic port forwarding may change the port number. If this is changed, the port number of the camera registered on the PC or recorder must be changed.
- The UPnP feature can be used to connect a camera to an IPv4 network. IPv6 is not supported.
- To verify that auto-port forwarding has been configured correctly, click on the **Status** tab on the Maintenance page and make sure that the **UPnP** status is **On**.  
→[Checking the camera status, p. 354](#)
- If **On** is not displayed, please read **Cannot access cameras from internet** in "Trouble!?"  
→[Troubleshooting, p. 411](#)
- If the live screen or configuration screen is not displayed correctly, such as when replacing the routers to be used, set **UPnP(Auto port forwarding)** to **Off** once and then set it to **On** again.

## Camera short cut

Use the **On** and **Off** buttons to specify whether to make shortcuts to the cameras in the **Network** folder of your computer.

Select **On** to shortcut the cameras.

#### NOTE!

- To use the camera shortcut function, enable the UPnP function on the PC beforehand.
- You must add a Windows component to view shortcuts to the cameras in the Windows **Network** folder. Enable UPnP by referring to the following.
- **Start > Set > Network and Internet > Ethernet > Network and Sharing Center > Enable Network Discovery in Change Shared Advanced Settings > Click Save Change.**

## Configuring HTTPS

By using the HTTPS function, you can encrypt the access to the camera and increase the security of communication.

#### NOTE!

When the HTTPS connection is accessed, only the camera accessed is protected.

## Connection

Set the connection method to the machine.

- HTTP: HTTP and HTTPS connections are enabled.
- HTTPS: Only the HTTPS connection is enabled.
- Select TLS to be used when HTTPS is selected. TLS1.1: Enable/disable.

#### NOTE!

- TLS1.2, TLS1.3 are always on and cannot be switched off.
- To connect to HTTPS when HTTP is selected, first configure the HTTPS connection. The HTTPS connection is enabled even if the setting is changed to HTTP.
- When accessing the camera with HTTPS, the display speed of the screen and the frame rate of the video may decrease.
- When accessing the camera with HTTPS, it may take a long time before the image is displayed.
- When you access the camera with HTTPS, the image may be distorted or the sound may be interrupted.
- If you set the connectivity to **HTTPS**, the maximum delivery is limited to 32Mbps.
- It is recommended that TLS 1.1 be disabled for security reasons.

## Select certificate

Select the certificate to use in HTTPS.

**Pre-installed:** Select the pre-installation certificate.

CA: Select a CA certificate. This is displayed only if the CA certificate is installed.

## HTTPS port

Set the port number to use for HTTPS. Configurable port number: 1~65535

The following port numbers cannot be set because they are used by this camera.

20, 21, 22, 23, 25, 42, 53, 67, 68, 69, 80 110, 123, 161, 162, 443,  
554, 995, 1883, 8883, 10669, 10670, 59000~61000

### NOTE!

<Multisensor>: The port numbers 32768 to 49151 cannot be set.

## Pre-installed certificate

### Download root certificate

Clicking **Execute** downloads the root certificate for the pre-installation certificate. By installing the root certificate on your PC, you can verify the signature of the pre-installation certificate.

## CA certificate

### CRT key generate

Creates a CRT key (SSL encryption key) for use in an HTTPS connection using a CA certificate. CRT key generation is performed in **CRT key generation dialog** displayed when **Execute** is clicked.

### Generate Certificate Signing Request

This generates a signature request (CSR Certificate Signing Request) to apply to a Certificate Authority when using a security certificate issued by a CA (Certificate Authority) as a security certificate to be used in HTTPS.

Create a signature request (CSR) by clicking on the **Execute** button. This is displayed in the **Create Signature Request (CSR) dialog**.

### CA Certificate install

Install the CA certificate (security certificate) issued by the certification authority and display information about the installed CA certificate (security certificate).

When **Select File** is clicked, the **Open Dialog** is displayed. Select the CA certificate (security certificate) file issued by the authentication authority. Click **Execute** to install the CA certificate (security certificate).

If a CA certificate (security certificate) is installed, the file name of the installed CA certificate (security certificate) is displayed.

### Information

The information of the CA certificate (security certificate) is displayed.

## Detailed settings

### Configuring the network

---

When **Execute** is clicked, the registered contents of the installed CA certificate (security certificate) are displayed in the **CA Certificate Confirmation Dialog**. If a CA certificate (security certificate) is not installed, the content of the generated signature request (CSR) is displayed.

Clicking **Delete** deletes the installed CA certificate (security certificate).

#### NOTE!

- When deleting a valid CA certificate (security certificate), make sure that you have a backup of the CA certificate (security certificate) on your PC or recording media. To reinstall, a CA certificate (security certificate) is required.
- If the connection method setting is changed, the connection must be accessed again after a while using `http://<IP address>` or `http://<IP address>`.
- When accessing the camera with HTTPS, the display speed of the screen and the frame rate of the video may decrease.
- When accessing the camera with HTTPS, it may take a long time before the image is displayed.
- When you access the camera with HTTPS, the image may be distorted or the sound may be interrupted.
- If you set the connectivity to **HTTPS**, the maximum bandwidth is limited to 32 Mbps.

## Configuring DDNS

To access the camera via the Internet, you must configure the DDNS function.

### Area

Select the region where the camera is installed.

### Service

Select whether or not to use the DDNS service to be used.

- **Off:** Do not use DDNS.
- **Dynamic DNS Update:** Dynamic DNS Update (RFC 2136 compliant) is used without DHCP.
- **Dynamic DNS Update (DHCP):** Dynamic DNS Update (RFC 2136 compliant) is with DHCP.

**NOTE!** Contact your network administrator if DHCP can be used for DDNS.

## Configuring SNMP

Here, the setting for the SNMP function is performed. Connecting using the SNMP Manager enables you to check the status of your camera. Contact your network administrator if you want to use the

SNMP feature.

## SNMP agent setting

### SNMP version

Select the SNMP version to be used.

#### SNMPv1/v2

### Community

Enter the community name to be monitored.

- Number of characters that can be entered: 0 to 32 characters
- Characters that cannot be entered: Double-byte
- Initial setting: Blank space

#### CAUTION!

- When using the SNMP feature on SNMPv1/v2, be sure to enter a community name. If the community name is blank, you cannot use the SNMP feature.
- Do not set a community name that can be easily guessed. (e.g., `public`).

### Manager address

When the SNMP version is v1 and v2, enter the IP address of the SNMP manager that allows requests. If blank, allow requests from all IP addresses.

- Number of characters that can be entered: 1 to 128 characters
- Input Characters: One-byte alphanumeric and one-byte symbols: . /

#### NOTE!

You can restrict the IP address of the SNMP manager to allow requests per subnet by entering the IP address/mask length of the subnet. For example, if you enter `192.168.0.1/24`, SNMP manager requests from `192.168.0.1` to `192.168.0.254` are allowed.

#### SNMPv3

### User name (1 to 32 characters)

Set the SNMPv3 username.

- Number of characters that can be entered: Blank or 1 to 32 characters
- Characters that cannot be entered: Double-byte and single-byte symbols " &; ¥

## Authentication

Select the SNMPv3 authentication method from MD5/SHA1.

## Encryption method

Select the SNMPv3 encryption method from DES/AES.

## Password (8 to 16 characters)

Set the SNMPv3 password.

- Number of characters that can be entered:
  - **MD5**: blank or 8-16 characters
  - **SHA1**: blank or 8-20 characters
- Characters that cannot be entered: Double-byte and single-byte symbols " &

## SNMPv2-MIB system setting

### System name

Enter the device name to manage the machine using the SNMP function.

- Number of characters that can be entered: 0 to 32
- Characters that cannot be entered: Double-byte

### Location

Enter the location where the machine was installed.

Number of characters that can be entered: 0 to 32 characters

### Contact

Enter the administrator's mail address or phone number.

- Number of characters that can be entered: 0 to 255
- Characters that cannot be entered: Double-byte

## SNMP trap setting

Sets ON/OFF of SNMP trap notification.

### Destination of Trap

### Address

Enter the destination address for the trap notification.

- Number of characters that can be entered: 1 to 128 characters
- Input Characters: One-byte alphanumeric and one-byte symbols:

### SNMPv2c

## Community

Enter the community name of the SNMP trap notification destination.

- Number of characters that can be entered: 0 to 32
- Characters that cannot be entered: Double-byte

## Trap setting

### SNMP Generic trap

## coldStart

If the check box is checked, the trap (SNMPv2-MIB:: coldStart) is notified when the camera starts.

### Trap string

If you want to extend the trap when the camera starts, you can set the character string.

- Number of characters that can be entered: 0 to 32 characters
- Input Characters: 0-9 (half-pitch), A-Z (half-pitch, uppercase, lowercase) and half-pitch symbol! " # \$ % & ' ( ) \* +, -. /; =?

## linkUp

When the checkbox is checked, the trap (SNMPv2-MIB:: linkup) is notified when the machine is linked up.

### Trap string

To extend the trap when the camera is linked up and notify, set the character string.

- Number of characters that can be entered: 0 to 32 characters
- Input Characters: 0-9 (half-pitch), A-Z (half-pitch, uppercase, lowercase) and half-pitch symbol! " # \$ % & ' ( ) \* +, -. /; =?

## authenticationFailure

If the check box is checked, a trap (SNMPv2-MIB:: authentication failure) is notified when an SNMP authentication error occurs.

### Trap string

If you want to extend the trap when an SNMP authentication error occurs, you can set the string.

## Detailed settings

### Configuring the network

---

- Number of characters that can be entered: 0 to 32 characters
- Input Characters: 0-9 (half-pitch), A-Z (half-pitch, uppercase, lowercase) and half-pitch symbol!  
" # \$ % & ' ( ) \* +, -. /:; =?

### Alarm

#### Terminal *n*

When the check box is checked, the trap is notified when an alarm is generated at terminal *n* (*n* = 1 to 3).

#### Trap string

Set the character string to be used for notifying **Terminal 1** traps.

- Number of characters that can be entered: 0 to 32 characters
- Input Characters: 0-9 (half-pitch), A-Z (half-pitch, uppercase, lowercase) and half-pitch symbol!  
" # \$ % & ' ( ) \* +, -. /:; =?

#### VMD

When the check box is checked, the trap is notified when the operation is detected.

#### Trap string

Specify the strings to be used to notify **VMD** traps.

- Number of characters that can be entered: 0 to 32 characters
- Input Characters: 0 to 9 (half-pitch), A to Z (half-pitch, uppercase, lowercase), half-pitch symbol!  
" # \$ % & ' ( ) \* +, -. /:; =?

#### Auto track

When the check box is checked, the trap is notified when automatic tracking occurs.

#### Trap string

Specify the strings to be used to notify **Auto track** traps.

- Number of characters that can be entered: 0 to 32 characters
- Input Characters: 0-9 (half-pitch), A-Z (half-pitch, uppercase, lowercase) and half-pitch symbol!  
" # \$ % & ' ( ) \* +, -. /:; =?

#### Audio detection

When the check box is checked, the trap is notified when sound detection occurs.

#### Trap string

Specify the strings to be used to notify **Audio detection** traps.



- Number of characters that can be entered: 0 to 32 characters
- Input Characters: 0-9 (half-pitch), A-Z (half-pitch, uppercase, lowercase) and half-pitch symbol! " # \$ % & ' ( ) \* +, -. /; =?

## Command alarm

When the check box is checked, the trap is notified when a command alarm occurs.

### Trap string

Specify the strings to be used to notify **Command alarm** traps.

- Number of characters that can be entered: 0 to 32 characters
- Input Characters: 0-9 (half-pitch), A-Z (half-pitch, uppercase, lowercase) and half-pitch symbol! " # \$ % & ' ( ) \* +, -. /; =?

## SD memory card

### Diag.

When the check box is checked, the trap is notified in the following cases.

- When notifying the remaining capacity of the SD card
- When the free space on the SD card is insufficient
- SD card recognition error

### Trap string

Specify the strings to be used to notify **Diag.** traps.

- Number of characters that can be entered: 0 to 32 characters
- Input Characters: 0-9 (half-pitch), A-Z (half-pitch, uppercase, lowercase) and half-pitch symbol! " # \$ % & ' ( ) \* +, -. /; =?

**NOTE!** <PTZ>: **Auto track** can be set only for PTZ-cameras.

## Configuring QoS

This section configures the settings for the Diffserv function and the shaping of streams.

### Diffserv

The Diffserv feature sets the priority of image/voice data forwarded from the router and other commands.

The priority you set on your camera must be matched to the DSCP value set on the router. Contact your network administrator if you want to use the Diffserv function.

#### Image DSCP (0-63)

Enter the packet priority order for the video data. Configurable values: 0~63

#### Audio DSCP (0-63)

Enter the packet priority order for audio distribution. Configurable values: 0~63

#### TCP alarm notification DSCP (0-63)

Enter the packet priority order for the unique alarm notification. Configurable values: 0~63

### Shaping of stream

Use **On/Off** to control whether H.265 (or H264) images are not bursted. This may be effective when network devices divert image data from the camera, etc., but the displayed image may be delayed.

#### NOTE!

If you are concerned about the delay of the image to be displayed, set it to **Off**.

## Configuring SRTP

Here, the settings for the SRTP function are performed.

### SRTP

Use **On** or **Off** to set whether to use the SRTP function.

#### NOTE!

You can also deliver RTP if SRTP is set to **On**.

## Configuring MQTT

This section configures the MQTT (*Message Queuing Telemetry Transport*) function. When an alarm is generated, the MQTT server can be notified of an event caused by the alarm.

### MQTT settings

Use **On/Off** to specify whether the MQTT function is enabled or not.

Connect to the configured server if it is set to **On** or **On** when the cameras are started. When the set alarm occurs, the setting is notified to the server.

#### Server

#### Address

Enter the IP address or host name of the MQTT server to be notified when an alarm is generated.

- Number of characters that can be entered: 1 to 128 characters
- Input Characters: One-byte alphanumeric and one-byte symbols: . \_ -

## Port number

Enter the MQTT server port number. Configurable port number: 1~65535

The following port numbers cannot be set because they are used by this camera.

20, 21, 22, 23, 25, 42, 53, 67, 68, 69, 80 110, 123, 161, 162, 443,  
554, 995, 1883, 8883, 10669, 10670, 59000~61000

### NOTE!

<Multisensor>: The port numbers 32768 to 49151 cannot be set.

## Protocol

Select the protocol to be used for connection with the MQTT server from the following.

- MQTT over SSL: Encrypt communication with the MQTT server via SSL.
- MQTT over TCP: Do not encrypt communication with the MQTT server.

## User name

Enter the user name to access the MQTT server.

- Number of characters that can be entered: 0 to 32 characters
- Characters that cannot be entered: Double-byte and single-byte symbols " &; ¥

## Password

Enter the password to access the MQTT server.

- Number of characters that can be entered: 0 to 32 characters
- Characters that cannot be entered: Double-byte and single-byte symbols " &

## Root CA certificate

## Installation

Install the root CA certificate issued by the certification authority.

1. When **Select File** is clicked, the **Open File Dialog** is displayed.
2. Select the root CA certificate file issued by the authentication authority.
3. Click **Execute** to install the root CA certificate.

**NOTE!** The data format of the root CA certificate can be PEM or DER.

## Information

The root CA certificate information is displayed.

- **Invalid:** Root CA certificate is not installed.
- `<Root CA certificate host name>`: Displayed when installed.
- You can view the root CA certificate in detail by clicking **Execute**.
- Clicking **Delete** deletes the installed root CA certificate.

## Server certificate verification

Select **MQTT over SSL** for **Protocol** and, if **Server certificate verification** is **On**, verify the server certificate using the root CA certificate registered when connecting to SSL.

### NOTE!

If the **Server certificate verification** is **On**, install the root CA certificate.

## Notification setting

### Alarm

Check the alarm event to notify the MQTT server.

- **Terminal *n***: Notifies the MQTT server when an alarm is generated at terminal ( $n = 1$  to 3).
- **VMD**: Notifies the MQTT server when an operation detection occurs.
- **Audio detection**: Notifies the MQTT server when sound detection occurs.
- **Command alarm**: Notifies the MQTT server when a command alarm is entered.

## Topic

Specify the name of the MQTT topic to be sent. The topics are hierarchically separated by `/`.

- Number of characters that can be entered: 1 to 128 characters
- Input Characters: Single-byte alphanumeric and single-byte symbols
- Prohibited Characters: One-byte symbol ¥

## Payload

Set the MQTT message payload.

- Number of characters that can be entered: 1 to 128 characters
- Input Characters: Single-byte alphanumeric and single-byte symbols
- Prohibited Characters: One-byte symbol ¥

## QoS

Select the QoS level.

0: Delivers up to one message. Messages are not guaranteed to reach the server.

1: Messages are delivered at least once. Messages are guaranteed to reach the destination, but may be duplicated.

2: Delivers the message exactly once. Messages are guaranteed to arrive only once without excess or deficiency.

## Retain

Check this box to store the last notified message saved on the MQTT server.

## MxMessageSystem settings

Using MxMessageSystem messages (*MxMessages* in short), you can trigger actions in other devices from this camera or you can use other devices to trigger actions in this camera.

- To trigger actions by sending MxMessages to other devices  
→ [MxMessage transmission setting, p. 343](#)
- To trigger actions when receiving MxMessages  
→ [MxMessage reception setting, p. 344](#)

**NOTE!** When you have configured the MxMessageSystem settings, click on **Set** at the bottom of the page to store the settings.

## MxMessageSystem

Use this section to configure the basic MxMessageSystem settings.

Network	Advanced	MxMessage System
MxMessage System	<input checked="" type="radio"/> Enable	<input type="radio"/> Disable
MxMessage System		
Password(PSK)	..... Inputtable characters: 1-byte alphanumeric characters, and 1-byte symbols (6 to 32 characters)	
Broadcast Port	19200 (1 - 65535)	
Advanced		
Resend	4 (1 - 16)	
Polling rate	4 (1 - 100)	
Max time offset	100 (1 - 36000)	

Use the **Enable/Disable** switch to switch the entire MxMessageSystem on or off, respectively.

## Password (PSK)

Enter a password that will be sent along with MxMessages and that will need to match when receiving MxMessages.

## Broadcast port

The messages are transferred using UDP Broadcast on the specified port. If you want to run several independent message systems on your network, assign different ports to the systems.

Configurable port number: 1~65535

The following port numbers cannot be set because they are used by this camera.

20, 21, 22, 23, 25, 42, 53, 67, 68, 69, 80 110, 123, 161, 162, 443, 554, 995, 1883, 8883, 10669, 10670, 59000~61000

### NOTE!

<Multisensor>: The port numbers 32768 to 49151 cannot be set.

## Advanced

### Resend

This parameter specifies how often *in total* the message will be resent. Many resends increase the probability that the message is actually received, but they also create heavier network load.

### Polling rate

This parameter specifies how often per second the messages will be sent. A higher frequency reduces latency, but creates heavier network load.

## Max. time offset

Maximum difference between the message timestamp and the system time. Messages with a greater difference are discarded. It is highly recommended to synchronize the system time of all message system components using NTP (→[Configuring NTP](#), p. 327).

## MxMessage transmission setting

MxMessage transmission setting		
Terminal alarm 1	Transmission setting	<input checked="" type="radio"/> On <input type="radio"/> Off
	MxMessage name	<input type="text"/>
Terminal alarm 2	Transmission setting	<input type="radio"/> On <input checked="" type="radio"/> Off
	MxMessage name	<input type="text"/>
Terminal alarm 3	Transmission setting	<input type="radio"/> On <input checked="" type="radio"/> Off
	MxMessage name	<input type="text"/>
VMD alarm	Transmission setting	<input type="radio"/> On <input checked="" type="radio"/> Off
	MxMessage name	<input type="text"/>
SCD alarm	Transmission setting	<input type="radio"/> On <input checked="" type="radio"/> Off
	MxMessage name	<input type="text"/>

\*The characters that can be entered for [MxMessage name] are 1-byte alphanumeric characters and 1-byte symbols (1 to 32 characters) except for "%", ":", "/", ". Only 1-byte alphabetic characters can be used as the first character.

### Terminal alarm *n*

Controls the three available profiles for sending MxMessages when detecting a terminal alarm.

#### Transmission setting

Activates/deactivates this MxMessage profile.

#### MxMessage name

Enter a valid MxMessage name in this field.

### VMD alarm

Sends an MxMessage when detecting a VMD alarm.

#### Transmission setting

Activates/deactivates this MxMessage profile.

#### MxMessage name

Enter a valid MxMessage name in this field.

## SCD alarm

Sends an MxMessage when detecting an SCD alarm.

### Transmission setting

Activates/deactivates this MxMessage profile.

### MxMessage name

Enter a valid MxMessage name in this field.

## MxMessage reception setting

MxMessage reception setting		
MxMessage1	Reception setting	<input checked="" type="radio"/> On <input type="radio"/> Off
	MxMessage name	<input type="text"/>
	<input type="checkbox"/> Day & Night(IR)	Off
	<input type="checkbox"/> Preset position setting	
	<input type="checkbox"/> Terminal 2 alarm output	
	<input type="checkbox"/> AUX output	Open
MxMessage2	Reception setting	<input type="radio"/> On <input checked="" type="radio"/> Off
	MxMessage name	<input type="text"/>
	<input type="checkbox"/> Day & Night(IR)	Off
	<input type="checkbox"/> Preset position setting	
	<input type="checkbox"/> Terminal 2 alarm output	
	<input type="checkbox"/> AUX output	Open
MxMessage3	Reception setting	<input type="radio"/> On <input checked="" type="radio"/> Off
	MxMessage name	<input type="text"/>
	<input type="checkbox"/> Day & Night(IR)	Off
	<input type="checkbox"/> Preset position setting	
	<input type="checkbox"/> Terminal 2 alarm output	
	<input type="checkbox"/> AUX output	Open

\*The characters that can be entered for [MxMessage name] are 1-byte alphanumeric characters and 1-byte symbols (1 to 32 characters) except for "%", ".", "/". Only 1-byte alphabetic characters can be used as the first character.

**Set**

This section allows configuring three different MxMessages to which the camera will react by executing the selected actions.



## MxMessagen

### Reception setting

Activates/deactivates this MxMessage profile.

### MxMessage name

Enter a valid MxMessage name in this field.

### Day & Night(IR)

When activated, uses the selected setting to control the Day & Night switch (→[D&N, p. 196](#)).

Select the mode for switching between black-and-white and color images.

- **Off:** It is always shot with color images.
- **On:** The picture is always taken in black and white.
- **Auto1(Normal):** The color image and black-and-white image are automatically switched depending on the brightness (illumination) of the image.
- **Auto2(IR Light):** The color image and black-and-white image are automatically switched depending on the brightness (illumination) of the image. This setting is used when near-infrared lighting is used at night.
- **Auto3(SCC):** Set this when you want to maintain a color image even when the light source is dark. The Super Chroma Compensation (SCC) function maintains the color image to low illumination.

→[What is Super Chroma Compensation \(SCC\)?, p. 196](#)

### Preset position setting

When activated, moves the PTZ head to the specified position (→[Setting preset positions, p. 234](#)).

### Terminal 2 alarm output

When activated, closes Terminal 2 to signal an alarm.

### AUX output

When activated, switches the AUX output to the selected condition (**Closed/Open**).

## Using schedules

Schedules are used to control actions and alarm detections for specific days and time ranges. You can define up to eight schedules.

## Defining schedules

### NOTE!

To finish, click on **Set** at the bottom of the page. This will store the schedules and will show them in the lower half of the screen.

Schedule		
Schedules		
Schedule 1 (White) <input type="checkbox"/>	Schedule mode	VMD permission <input type="text"/>
	Time range	<input checked="" type="checkbox"/> Mon <input checked="" type="checkbox"/> Tue <input checked="" type="checkbox"/> Wed <input checked="" type="checkbox"/> Thu <input checked="" type="checkbox"/> Fri <input checked="" type="checkbox"/> Sat <input checked="" type="checkbox"/> Sun <input type="checkbox"/> 24h    09:00 - 17:00
Schedule 2 (Blue) <input checked="" type="checkbox"/>	Schedule mode	VMD permission <input type="text"/>
	Time range	<input checked="" type="checkbox"/> Mon <input checked="" type="checkbox"/> Tue <input checked="" type="checkbox"/> Wed <input checked="" type="checkbox"/> Thu <input checked="" type="checkbox"/> Fri <input checked="" type="checkbox"/> Sat <input checked="" type="checkbox"/> Sun <input type="checkbox"/> 24h    23:00 - 07:00
Schedule 3 (Green) <input checked="" type="checkbox"/>	Schedule mode	FTP/SFTP periodic image transi <input type="text"/>
	Time range	<input type="checkbox"/> Mon <input type="checkbox"/> Tue <input type="checkbox"/> Wed <input type="checkbox"/> Thu <input type="checkbox"/> Fri <input checked="" type="checkbox"/> Sat <input checked="" type="checkbox"/> Sun <input checked="" type="checkbox"/> 24h    00:00 - 00:00
Schedule 4 (Red) <input checked="" type="checkbox"/>	Schedule mode	Off <input type="text"/>
	Time range	<input type="checkbox"/> Mon <input type="checkbox"/> Tue <input type="checkbox"/> Wed <input type="checkbox"/> Thu <input type="checkbox"/> Fri <input type="checkbox"/> Sat <input type="checkbox"/> Sun <input type="checkbox"/> 24h    00:00 - 00:00

### Schedule mode

Use this setting to control what the camera should do while this schedule is active.

**NOTE!**

The options of this dropdown are different for the Multisensor and PTZ parts of the camera.

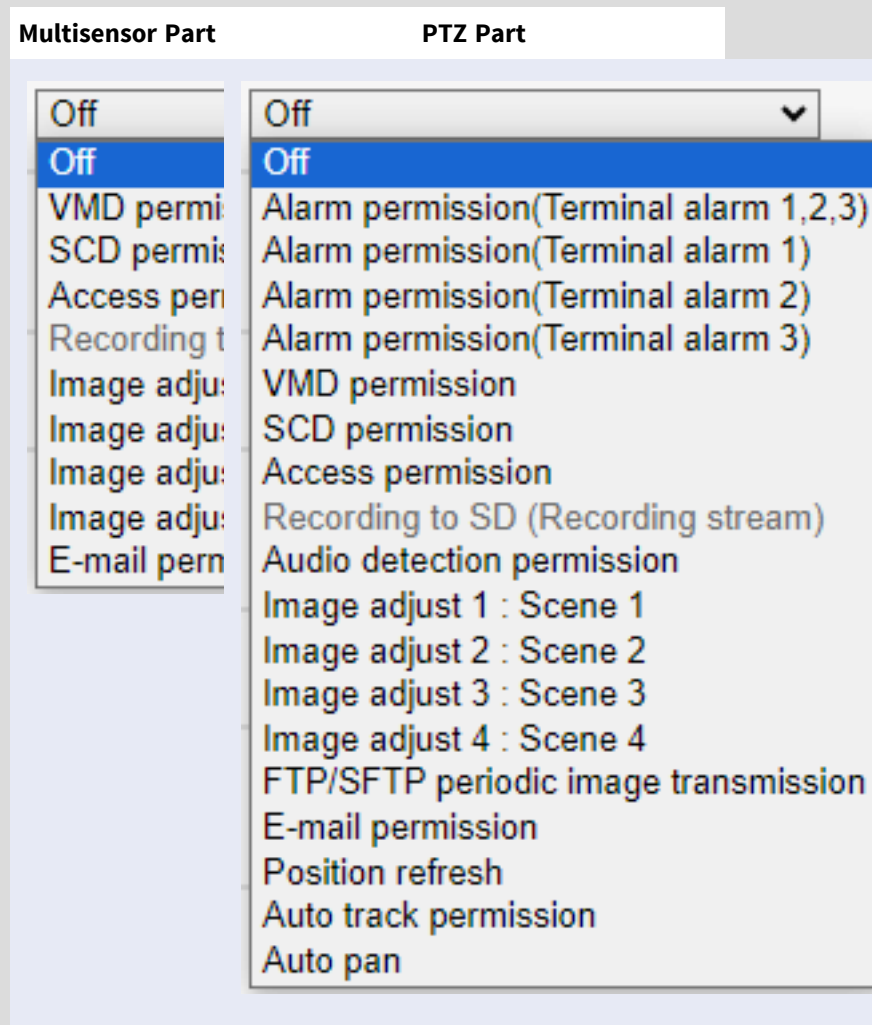

Select one of the settings below to permit the corresponding actions and alarm detections while the schedule is active.

- **Off:** Deactivates the schedule.
- **Alarm permission(Terminal alarm 1,2,3):** Alarm input of all terminal contacts.
- **Alarm permission(Terminal alarm *n*):** Alarm input of terminal *n*.
- **VMD permission:** VMD detection.
- **SCD permission:** SCD detection.
- **Audio detection permission:** Audio detection.
- **Access permission:** Images can be viewed by users with these access levels (→[Configuring user authentication](#), p. 293):
  - **2. Camera control**
  - **3. Live view**

## Detailed settings

### Using schedules

---

- **SD memory recording:** SD recording as set by **Recording stream**.
- **Image adjust *n*: Scene *n*:** Set image quality to **Scene 1**. Outside of the scheduled times, image quality assumes the **Scene file is not applied** setting.
- **FTP/SFTP periodic image transmission:** Executes FTP/SFTP periodic transmissions.
- **Email permission:** Sends e-mails if an alarm is generated.
- **Reboot:** Restarts the camera at the scheduled time. *Only available in **Schedule 8**.*
- **Position refresh:** Resets the camera position at the scheduled time.
- **Auto track permission:** Activates auto-tracking.
- **Auto pan:** Activates auto pan operation.
- **Patrol *n*:** Activates Patrol *n* (only if **Patrol *n*** has been set; →[Patrol, p. 234](#)).
- **Preset sequence *n*:** Activates Sequence *n* (only if **Sequence *n*** has been set; →[Preset sequence setting, p. 233](#)).

#### NOTE!

- When using **Access permission**, set **User auth.** to **On** and **Host auth.** to **Off**.  
→[Configuring user authentication, p. 293](#)  
→[Configuring host authentication, p. 296](#)
- If you want to use **SD memory recording**, set **Recording format** in the **SD card** tabs to streams and set **Save trigger** to **Schedule**.

## Setting the time/time range

#### NOTE!

When configuring **Auto pan**, **Patrol**, and **Preset sequence** schedules, make sure the times do not overlap.

- Tick the days on which you want to use this schedule.
- Click the ▼ arrows to set the start and end times (if available).
- Select **24h** for the entire day.

## Schedule display

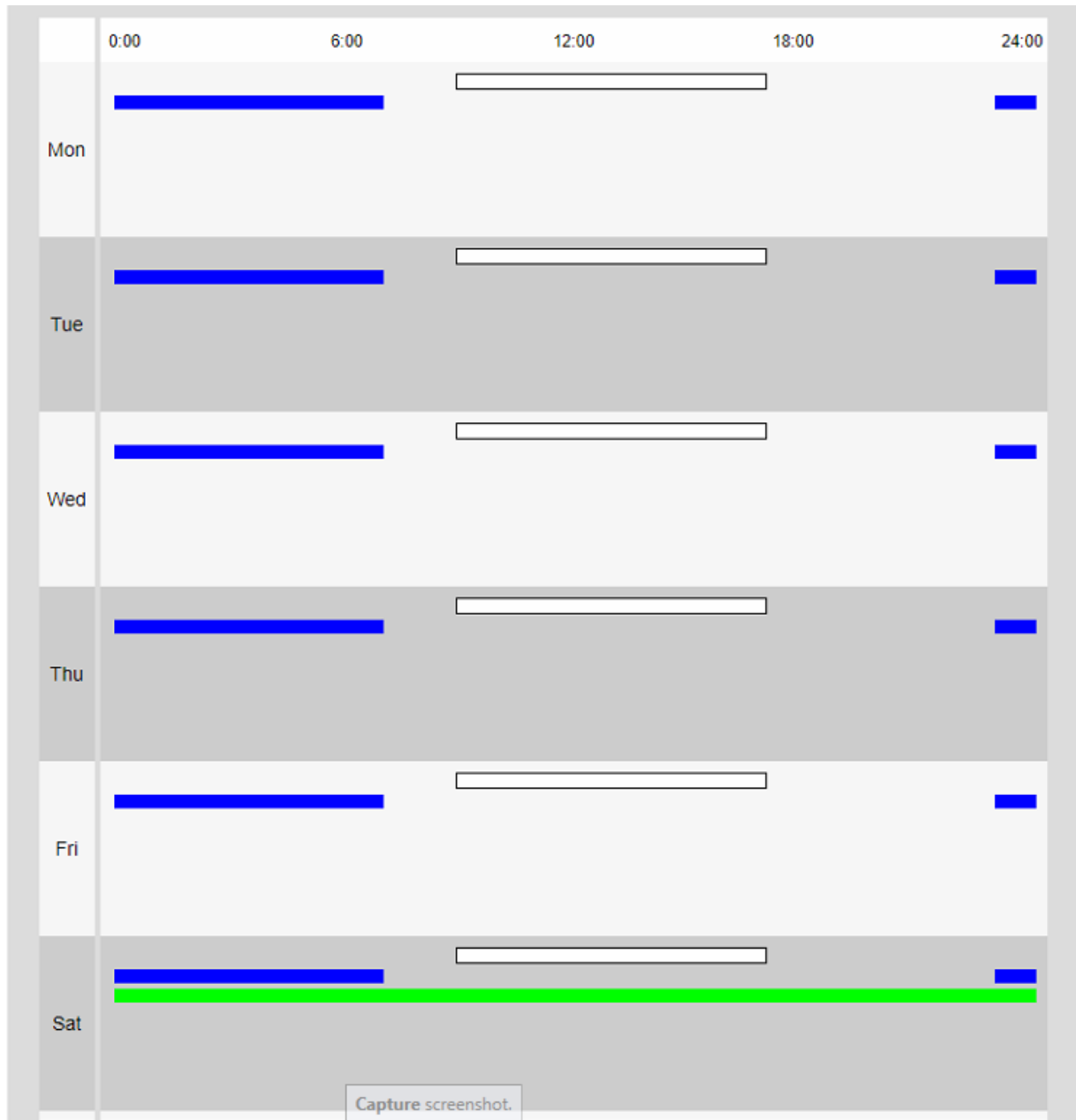

### NOTE!

- The colors displayed on Schedules 1 to 8 represent the colors of the lines displayed in the Schedule field at the bottom of the screen.
- If position refresh and image quality set time are set at the same time, position refresh takes precedence.

## Deleting schedules

Schedule 1 (White) <input type="checkbox"/>	Schedule mode	Off <input type="button" value="v"/>
	Time range	<input type="checkbox"/> Mon <input type="checkbox"/> Tue <input type="checkbox"/> Wed <input type="checkbox"/> Thu <input type="checkbox"/> Fri <input type="checkbox"/> Sat <input type="checkbox"/> Sun <input type="checkbox"/> 24h <input type="text" value="00"/> <input type="text" value="00"/> : <input type="text" value="00"/> <input type="text" value="00"/> - <input type="text" value="00"/> <input type="text" value="00"/> : <input type="text" value="00"/> <input type="text" value="00"/>

To delete a schedule, set **Schedule mode** to *Off*, then click **Set** at the bottom of the page.

## Camera maintenance

Open the **Maintenance** page to check the system log, do software upgrades, check the status of the camera, and to initialize it.

## Checking the system log entries

Click **System log** in the Maintenance page. Refer to the following how to display and operate the **Detailed settings** menu.

→[Accessing the camera settings menu, p. 109](#)

→[Editing the camera settings, p. 111](#)

### NOTE!

- If **SD card** is set to **Use** and an SD card is installed on your camera, up to 4000 system log entries can be saved in the SD card.  
→[SD card options, p. 154](#)
- If **SD card** is set to **Not use**, up to 100 system log entries can be saved in the camera's internal memory.
- When reaching the maximum number of system log entries, a new entry will overwrite the oldest entry.
- 100 system log entries are displayed on one page.
- Log entries are saved permanently (even after power had been lost).

## Log navigation

### |<< Latest 100 items

Click to display the last 100 log entries.

### Next 100 items >>|

Click to display the next 100 log entries.

## Page number display

The currently open page is displayed in the form **Page/Total Page**.

### |<<Previous 100 items

Click to display 100 items before the displayed log entries.

## Log columns

### No

Lists the current number of the log entry.

### Time & date

Lists the date and time when the camera recorded the log entry.

#### NOTE!

If **Time display format** is set to **24h**, the logging date and time will be displayed in 24-hour format.

## Description

Lists the contents of the log entry (for explanations →[System log explanations, p. 405](#)).

## Upgrading the software

Click **Upgrade** in the Maintenance page. Here, you can review the software version and update the software to the latest version.

→[Accessing the camera settings menu, p. 109](#)

→[Editing the camera settings, p. 111](#)

#### NOTE!

Before upgrading the software, consider backing up the configuration data (especially when restoring the camera defaults).

→[Backing up camera data, p. 358](#)

#### CAUTION!

- Use a PC on the same subnet as the camera to upgrade the version.
- Use our specified img file for the software to be used to upgrade the version. Be sure to store the file as <model\_name\_>.img when storing the software file (xxxxxx contains the software version).
- Do not turn off the camera during software upgrading.
- Do not open, close or manipulate browser window while upgrading until it has completed successfully.
- Display plug-in software must be licensed for each PC. Contact your dealer for a license.

## Protected settings when resetting the camera

The following settings will not be changed when resetting the camera.

- IPv4 DNS primary server address
- Secondary server address
- IPv6 primary server address
- DNS secondary server address
- DHCP settings
- IP address and subnet mask
- Default gateway
- HTTP/HTTPS port and connection method
- CRT key
- CA certificate
- UPnP settings
- Bit rate settings
- Time settings
- IEEE802.1X settings
- Function extension software and settings



## Camera information

The section at the top shows the following camera information:

System log		Upgrade	Status	Default reset	Data
Model no.		Mx-VMSD1A2021VA_M			
MAC address		00-03-C5-C2-00-1B			
Serial no.		10.194.0.27			
Firmware version		1.00			
Camera information of the same housing					
IP address		10.194.0.26			
MAC address		00-03-C5-C2-00-1A			
Firmware version		1.00			
IP address(IPv6)	Linklocal	fe80::203:c5ff:fec2:1b			
	Static				
	RA				
	DHCPv6				

## Upgrading the camera software

Datei auswählen

Keine ausgewählt

Reset the settings to the default after completing the upgrade.  
(Except the network settings)

Do not reset the settings to the default after the upgrade.

Execute

It will take around 7 minutes to complete the upgrade.  
Please wait and do not operate the browser during this process.

- Download the latest camera software from the [MOBOTIX Download Center](#).
- Make sure the path to the download folder does not contain spaces or double-byte characters.
- Click **Select File** and select the file you downloaded.
- Decide if you want to reset the camera (except the settings mentioned in [Protected settings when resetting the camera, p. 352](#)) when upgrading the software.
- Click on **Execute**.
- Confirm the message to start the upgrade process.

## After upgrading the software

- Check the version on this page.
- In case the upgrade process fails, →[Troubleshooting, p. 411](#)

## Checking the camera status

Click **Status** in the Maintenance page to check the status of the camera.

→[Accessing the camera settings menu, p. 109](#)

→[Editing the camera settings, p. 111](#)

## UPnP

### Port number (HTTP/HTTPS)

The port number configured for port forwarding in UPnP is displayed.

### Status

The state of the port forwarding is displayed.

### Router global address

The global address of the router is displayed.

## Self check

The hardware self-diagnosis results are displayed.

## Hardware information

**NOTE!** This section is displayed for the PTZ part of the camera.

### Number of times of pan/tilt operation

The number of PAN and TILT operations and the last replacement time are displayed. Press the **Execute** button of the **Reset at the time of replacement** button to change the operation count to zero and the last replacement time is updated.

### Number of times of zoom/focus operation

The number of ZOOM and FOCUS operations and the last replacement time are displayed. Press the **Execute** button of the **Reset at the time of replacement** button to change the operation count to zero and the last replacement time is updated.

### Status

The number of starts, energizing time, temperature sensor information, heater information, etc. are displayed.

## SD Card

### Model no.

Displays the model number of the SD card. If the product number data acquisition fails, **Read error** is displayed. When the SD card is not used, **Not use** is displayed.

Otherwise, **Unknown** is displayed.

### Serial no.

Displays the SD card serial number. If the serial number is not obtained, **Unknown** is displayed.

### Remaining capacity

Displays the remaining capacity and total capacity of the SD card. The **SD card** tab-SD card info **Remaining capacity** on the Basic Page and the displayed content are the same.

### Total use time

Displays the energizing time of the machine with the SD card inserted. If it fails to acquire the operating hours, **Unknown** is displayed. The operating time is updated once an hour.

## Number of overwrite times

Displays the total capacity of the SD card, the number of files written to the SD card by the camera, and the number of times of overwriting calculated from the file size. If the overwrite count fails, **Unknown** is displayed.

### NOTE!

- The number of times of overwriting is an estimate calculated in the camera and may differ from the actual number of times of overwriting.
- If you use **SD card password lock** and the passwords of SD cards do not match, the above information will not be displayed.

## No.|Time & date|Description

Displays the SD card log.

Entry	Explanation
<SD > Format	The SD card was successfully formatted.
<SD > Format error	An error occurred in the SD card format.
<SD > Recognition error	The SD card cannot be recognized correctly.
<SD > Write error	An error occurred during write processing of the SD card.
<SD > Read error	An error occurred during read processing of the SD card.
<SD > Deletion error	An error occurred during deletion processing of the SD card.
<SD > Files system error	An error occurred in the file system of the SD Memory Card.
<SD > Other errors	Other errors have occurred on the SD Memory Card.
<SD > The SD card recording continuity is wrong. Check the recording bit rate setting on the SD Memory Card.	Data is missing during write processing on the SD card.
<SD > An error occurs in the SD card. Check the SD card status.	Data is continuously missing during write processing on the SD card. Confirm that the SD card is correctly recognized. If not, restart the camera or unplug the SD card and insert it again.

**NOTE!**

- To use this function correctly, format the SD card on your computer before using the SD card.
- The correct information may not be displayed on the SD card used on a computer other than this unit.
- Up to 30 SD card logs can be saved in the internal memory of this camera. If the maximum number of system logs that can be saved is exceeded, the log is overwritten from the old log.

## Initializing/restarting the camera

Click **Default reset** in the Maintenance page to initialize the camera's setup data and restart the camera.

→[Accessing the camera settings menu, p. 109](#)

→[Editing the camera settings, p. 111](#)

### Reset to the default (Except the network settings)

When **Execute** is clicked, the camera settings are reset to defaults. However, the network-related settings are not initialized.

When the initialization operation is performed, the product cannot be operated for approximately 3 minutes.

### Load the default HTML files (setup menu)

**Execute** returns HTML files to their defaults.

When the initialization operation is performed, the product cannot be operated for approximately 3 minutes.

### Reset to the default and load the default HTML files

Press **Execute** to reset the camera settings and HTML files to their defaults. However, the network-related settings are not initialized.

When the initialization operation is performed, the product cannot be operated for approximately 3 minutes.

## Reboot

Press **Execute** to restart the camera. After restarting, the product cannot be operated for about two minutes as it was when the power was turned on.

## Position refresh

Refresh the machine position. The position can be corrected if the camera is misaligned with the home position or preset position while the camera is in use or if the camera is misdirected while the camera is powered on.

When position refresh is performed, operation cannot be performed for approximately 2 minutes.

### NOTE!

- If you install the camera, the camera may be turned by mistake. When registering a preset after installation, it is recommended to perform position refresh.
- Please refer to the following for the network settings.  
→[Basic network settings, p. 309](#)
- When you select the Alarm or Mail Notification function, if the SD card is not installed after restarting, you can notify the set **Destination Email address** or **Destination of notification**.  
→[Configuring SMTP \(E-mail\), p. 315](#)  
→[Configuring alarm notifications, p. 287](#)

## Backing up/restoring configuration data and logs

Click **Data** in the Maintenance page to back up/restore your camera's setup data, scene files, and save your log.

→[Accessing the camera settings menu, p. 109](#)

→[Editing the camera settings, p. 111](#)

## Backing up camera data

Use the buttons in the **Backup** section for this operation.

## Setup data

You can back up the camera settings to your computer by clicking **Execute**. The `<model name>.txt` file will be created in your **Download** folder.

## Scene file

By clicking on **Execute**, you can back up the scene file settings for your camera. The `<model name>.txt` file will be created in your **Download** folder.

## Logs

You can back up your camera's logs by clicking **Execute**. The `syslog.tgz` file will be created in your **Download** folder.

### CAUTION!

- It takes a long time to create a backup file when backing up configuration data and logs.
- If the backup operation takes more than 10 minutes, a communication timeout may have occurred. At this time, the backup data may not have been obtained completely, so please complete it within 10 minutes. You can also check whether the correct data was obtained by restoring the acquired data (excluding log data).
- To extract the contents of the `syslog.tgz` file, use a third-party tool (e.g. 7zip).

## Restoring camera data

Use the buttons in the **Restore** section for this operation.

## Setup data

- Press **Select File** and select the `<model name>.dat` file you want to restore.
- Decide if you want to reset the camera (except the settings mentioned in [Protected settings when resetting the camera, p. 352](#)) when upgrading the software.
- Click **Execute** to start the process. After completion, the system will restart. Do not operate the screen until the process has finished successfully.

### CAUTION!

If it takes more than five minutes to restore the setting data, the restore process may have failed due to a communication error. In that case, restart the restore process.

### Scene file

- Press **Select File** and select the `<model name>.txt` file you want to restore.
- Click **Execute** to start the process. Do not operate the screen until the process has finished successfully.

## Support

The **Support** page contains a list of applicable licenses. Click on **Click on OSS information** to display it.



## Technical Support Information

This section contains the following information:

<b>Technical Specifications</b> .....	<b>362</b>
<b>DORI Specifications</b> .....	<b>367</b>

# Technical Specifications

## Product Information

Product Name	Vandal Multisensor PTZ Combo 20MP Video Analytics Camera
Order Code	Mx-VMSD1A-2021-VA

## Hardware Design

Processor	<Multisensor>: Ambarella CV2 (Quad-core ARM® Cortex®-A53, 1 GHz) <PTZ>: Ambarella CV25m (Quad-core ARM® Cortex®-A53, 1 GHz)
Memory	RAM: 1 GByte FLASH: 256 MBytes
Image Sensors	<Multisensor>: 4 x 5MP 1/2.7" Progressive CMOS <PTZ>: 1 x 2MP (1080p) 1/2.8" Progressive CMOS
Effective (Used) Pixels	<Multisensor>: 2560x1920 (5MP) (per image sensor) <PTZ>: 1920x1080 (2MP)

## Lens

Optical Zoom	<Multisensor>: 1x <PTZ>: 21x (motorized zoom/motorized focus)
Digital Zoom	<Multisensor>: max. 4x (resolution 640x360) <PTZ>: max. 31x (resolution 1280x720)
Minimum Illumination	<p><b>&lt;Multisensor&gt;</b></p> <p>Color: 0.12 lx (30IRE, F2.0, 1/30 s) Color: 0.17 lx (50IRE, F2.0, 1/30 s) BW: 0.10 lx (50IRE, F2.0, 1/30 s)</p> <p><b>&lt;PTZ&gt;</b></p> <p>Color: 0.011 lx (30IRE, F1.6, 1/30 s) Color: 0.015 lx (50IRE, F1.6, 1/30 s) BW: 0.006 lx (50IRE, F1.6, 1/30 s)</p>

Focus Adjustment <Multisensor>: –  
<PTZ>: Auto focus

Lens Characteristics (per image sensor) <Multisensor>  
Focal length: 3.2 mm  
Aperture: F1.6  
Field of view: horizontal 97°, vertical 71°  
Focus range: 1 m/3.28 ft to ∞  
<PTZ>  
21x motorized lens: zoom, focus  
Focal length: 4.0 to 84.6 mm  
Aperture: F1.6 (wide), F4.5 (tele)  
Field of view: horizontal 3.7 to 77°, vertical 2.2 to 44°  
Focus range: 1.5 m/4.92 ft to ∞

## Camera

Shutter Speed <Multisensor>: 15 fps: 1/10000s to 16/30s  
<PTZ>: 15/30/60 fps: 1/4000s to 16/30s

Shutter Priority Mode Up to 1/45s

Frame Rates (maximum) <Multisensor>  
H.265/H.264: 5MP@15 fps  
MJPEG: 1080p@15 fps  
<PTZ>  
H.265/H.264: 2MP (1080p)@60 fps  
MJPEG: 1080p@60 fps

Auto Gain Min. gain: 0 dB, max. gain: 11 dB, step size: 1

WDR <Multisensor>: 108 dB max.  
<PTZ>: 144 dB max.

White Balance ATW1/ATW2/AWC

Back Light/High Light Compensation BLC (Back light compensation)/HLC (High light compensation)/Off (only when Super Dynamic/Intelligent Auto: Off)

Fog Compensation On/Off (only when Intelligent Auto/Auto Contrast Adjust: Off)

Maximum Gain (AGC) Level 0 to 11

Color/BW (ICR) Off/On/Auto1(Normal)/Auto2(IR Light)/Auto3(SCC)

Digital Noise Reduction Level 0 to 255

## Technical Support Information

### Technical Specifications

---

Image Rotation	180°
Adjusting Angles	<b>&lt;Multisensor&gt; Camera 1,2,3,4:</b> Vertical: 40 ±7° (adjust by vertical (TILT) angle) <b>&lt;PTZ&gt;</b> Horizontal: 360° endless panning Vertical: -15 to +195°/Yaw: 0°

### PTZ Features (<PTZ> Only)

Preset Positions	256
Auto Mode	Auto track/Auto pan/Preset sequence/Patrol
Auto Return	10 s/20 s/30 s/1 min/2 min/3 min/5 min/10 min/20 min/30 min/60 min
Pan Range	360° endless
Tilt Range	-15° to +195°
Pan Speed	Manual Pan Speed: 0.065° to 150°/s Preset Pan Speed: Up to 500°/s
Tilt Speed	Manual Tilt Speed: 0.065° to 150°/s Preset Tilt Speed: Up to 500°/s

### Video Codec

Compression/Encoding	H.265/H.264/MJPEG
Streaming	Up to 4 individually configurable streams for MS and 1 combined stream in H.264/H.265/MJPEG Configurable resolution, frame rate, bandwidth CBR/VBR in H.265/H.264.

### Audio Codec

Compression/Encoding	G.711/G.726/AAC-LC
Streaming	Bi-directional
Audio Input	3.5 mm stereo mini jack
Audio Output	3.5 mm stereo mini jack

## Cyber Security Features

Password Protection	Yes
IEEE 802.1X network access control	Yes (for advanced network security and authentication)
Digest authentication	Yes (for secure user authentication)
FIPS 140-2 Level 3	Yes (NXP® EdgeLock® SE050F Trusted Platform Module: Certificate #3840) Security Level Exceptions: <ul style="list-style-type: none"><li>▪ Physical Security: Level 4</li></ul>
Secure Boot	Yes (support of fixed IP setting and automatic DHCP IP configuration according to individual MAC address)
AES encryption for password protection	Yes (to ensure strong encryption for password storage)
HTTPS/SSL (using TLS)	Yes
Digital Certificate	Yes, GlobalSign® device certificate pre-installed
User Authentication	Yes
Host Authentication	Yes
Alteration Detection	Yes

## Network

Interface	10/100/1000 Mbps Ethernet
Supported Protocols	ARP, IPv6, ICMP, TCP, UDP, DHCPv6, SNMP, SMTP, RTP, HTTP, HTTPS, NTP, DNS, LLDP, MQTT, IEEE 802.1X, MLD
ONVIF Conformance	Supports profiles S/G/T/M
Supported Browsers	Microsoft Edge, Firefox, Google Chrome
Concurrent Users	<Multisensor>: 24 (depending on network load) <PTZ>: 14 (depending on network load)

## System Integration

Video Motion Detection (VMD)	On/Off, up to 4 areas
Scene Change Detection (SCD)	On/Off, up to 1 area
Audio Detection	On/Off
AI Sound Classification	Selectable from Gunshot, Yell, Vehicle horn, Glass break
AI Analytics	<ul style="list-style-type: none"> <li>▪ AI Video Motion Detection</li> <li>▪ AI Privacy Guard</li> <li>▪ AI Face Detection</li> <li>▪ AI People Detection</li> <li>▪ AI Vehicle Detection</li> <li>▪ AI No-mask Detection</li> <li>▪ AI Occupancy Detection</li> <li>▪ AI Scene Change Detection</li> </ul>
Alarm Sources	3 input pins, VMD alarm, SCD alarm, Command alarm, Audio detection alarm
Alarm Actions	SD card recording, E-mail notification, HTTP alarm notification, Indication on browser, TCP alarm notification
Privacy Zones	<p>&lt;Multisensor&gt;: On/Off, up to 8 zones</p> <p>&lt;PTZ&gt;: On/Off, up to 32 zones</p>
VIQS	<p>&lt;Multisensor&gt;: On/Off, up to 8 zones</p> <p>&lt;PTZ&gt;: On/Off, up to 8 zones</p>
Camera Title (OSD)	On/Off, up to 40 characters, up to 2 Lines (alphanumeric and special characters)

---

## General

Housing Materials	<p>Main body: Aluminum die cast, white</p> <p>Outer fixing screws: stainless steel (corrosion-resistant treatment)</p> <p>Dome cover: PC resin, clear</p>
Housing Color	RAL 9003

---

Power Requirements	PoE++ (IEEE802.3bt compliant): DC 54 V: 0.66 A/max. 35.6 W (Class 5 device)
Connectors	<ul style="list-style-type: none"> <li>▪ Network: 10 BASE-T/100 BASE-T/1000 BASE-T, RJ45 connector</li> <li>▪ Audio input: 3.5 mm stereo mini jack</li> <li>▪ Audio output: 3.5 mm stereo mini jack</li> <li>▪ Alarm I/O: 3x Alarm in, 2x Alarm out</li> </ul>
Video Storage	microSD SDHC/SDXC card support up to 512 GB Support for recording to NAS, MOBOTIX HUB, MOBOTIX MOVE NVR
Remotely Upgradable	Yes
Environmental Protection Class	IP66/IP67/IK10, Type 4X (UL50E), NEMA 4X-compliant
Operating Temperature	–40 to +55 °C/–40 to 131 °F (Power On range: –20 to +55 °C/–4 °F to 131°F) Maximum temperature according to NEMA TS 2 (2.2.7): 74°C/165°F
Relative Humidity	10 to 100 % non-condensing (using Temish element to protect against condensation)
Approvals	EMC: FCC (Part15 ClassA), ICES-003 ClassA, EN55032 ClassA, EN55024 Safety: UL (UL62368-1), c-UL (CSA C22.2 No.62368-1), CE, IEC62368-1 IT Security: FIPS 140-2 Level 3-certified (using certified TPM chipset)
Other Supported Standards	NEMA TS 2 (2.2.7-2.2.9)
Warranty	5 years; mechanically wearable parts (motor, gears, belts, etc.) excluded
Dimensions	ø 250 x 195 mm
Weight	3800 g

**NOTE!** Observe the [MOBOTIX MOVE Installation Hints](#) document to ensure optimum performance of the camera features.

## DORI Specifications

In the video surveillance context, “DORI” stands for Detection, Observation, Recognition and Identification and is based on IEC EN62676-4: 2015. These levels define the minimum pixels that a face

of a person must have to provide proper identification, for example.

- **Detection:** Up to this distance, you can reliably determine if a person or vehicle is present.
- **Observation:** Up to this distance, you can see characteristic details of an individual, such as distinctive clothing.
- **Recognition:** Up to this distance, you can determine with a high degree of certainty whether an individual is the same as someone that has been seen before.
- **Identification:** Up to this distance, you can determine the identity of an individual beyond reasonable doubt.

## Multisensor Cameras

DORI Level	Detection	Observation	Recognition	Identification
Mx-VMUSD1A-2021-VA	45.3 m/148.6 ft	18.1 m/59.4 ft	9.1 m/29.7 ft	4.5 m/14.9 ft

## PTZ Camera

DORI Level	Detection		Observation		Recognition		Identification	
	Wide	Tele	Wide	Tele	Wide	Tele	Wide	Tele
Mx-VMUSD1A-2021-VA	48.3 m/ 158.4 ft	1188.9 m/ 3900.5 ft	19.3 m/ 63.4 ft	475.5 m/ 1560.2 ft	9.7 m/ 31.7 ft	237.8 m/ 780.1 ft	4.8 m/ 15.8 ft	118.9 m/ 390.0 ft



## Appendix

This section contains the following information:

<b>AI-VMD for object detection and counting</b> .....	<b>370</b>
<b>System log explanations</b> .....	<b>405</b>
<b>Troubleshooting</b> .....	<b>411</b>
<b>SD card folder structure</b> .....	<b>419</b>
<b>Minimum hardware requirements for computers</b> .....	<b>421</b>

# AI-VMD for object detection and counting

The AI-VMD (WV-XAE200W) extension software provides a method to conveniently use the video motion detection (“VMD”) in the Vandal Multisensor PTZ Combo 20MP Video Analytics Camera network camera.

**NOTE!** This extension software requires a license key. Please note that the license is already pre-installed; no action for using this extension software is required on your part.

## Introduction

### Cross Line Counting function

AI-VMD can count humans, vehicles (four-wheel vehicles), motorcycles and bicycles (two-wheel vehicles) crossing a line, and can provide statistics on the count data.

### AI-VMD

With AI technology, AI-VMD determines whether the detected moving body is a vehicle (four-wheel), a motorcycle or a bicycle (two-wheel), or a human.

AI-VMD can detect moving bodies in the four modes below and can trigger the corresponding alarms.

- INTRUDER: Detects moving bodies intruding into the detection area.
- LOITERING: Detects moving bodies loitering in the detection area longer than the specified time.
- DIRECTION: Detects bodies moving in the specified direction within the detection area.
- CROSS LINE: Detects bodies moving cross a line and in the direction you specified.

Below are examples of each detection. The example of DIRECTION is a case where bicycles are set as the detection objects.

## INTRUDER



An alarm occurs when moving bodies are detected intruding into the predetermined area.

## DIRECTION

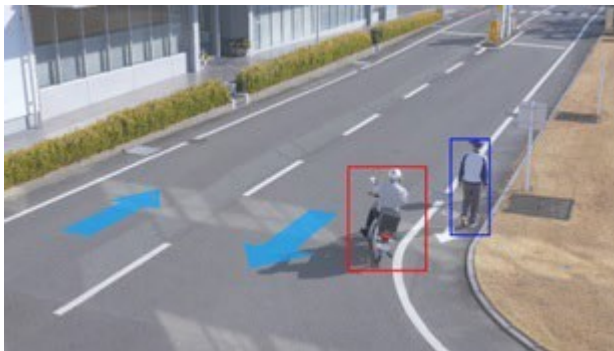

An alarm occurs when moving bodies are detected moving in the direction you specified within the predetermined area.

## LOITERING

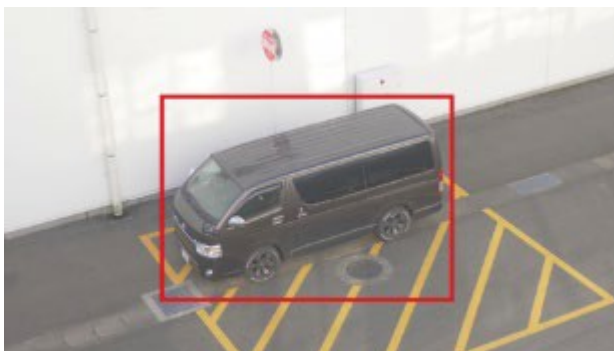

An alarm occurs when moving bodies are detected intruding into the predetermined area.

## CROSS LINE



An alarm occurs when moving bodies are detected crossing the predetermined line in the direction you specified.

## About these Operating Instructions

This part of the manual explains the settings that need to be made before starting to use this software, and the method of operation for using this product.

### NOTE!

- Based on the specific model of a camera which is used, its screen may be different from the screen shown in this manual.
- In this manual, a personal computer is referred to as a PC.
- In this manual, "moving body(s)" is sometimes written as "object(s)" to suit the display.

## Open source software used

This product uses the open source software below.

Name of software	Name of license
OpenCV	License Agreement For Open Source Computer Vision Library (3-clause BSD License)
cwebsocket	The MIT License
libjpeg-turbo	<ul style="list-style-type: none"><li>▪ The IJG (Independent JPEG Group) License</li><li>▪ The Modified (3-clause) BSD License</li><li>▪ The zlib License</li></ul>

---

For the corresponding license texts, see [Open Source Software Licenses, p. 402](#).

---

## Copyright

Distributing, copying, disassembling, reverse compiling and reverse engineering of the software provided with this product are all expressly prohibited. In addition, exporting any software provided with this product violating export laws is prohibited.

## Disclaimer of warranty

IN NO EVENT SHALL MOBOTIX AG BE LIABLE TO ANY PARTY OR ANY PERSON, EXCEPT FOR REPLACEMENT OR REASONABLE MAINTENANCE OF THE PRODUCT, FOR THE CASES INCLUDING BUT NOT LIMITED TO BELOW:

1. ANY LOSS OR DAMAGE, INCLUDING WITHOUT LIMITATION, DIRECT OR INDIRECT, SPECIAL, CONSEQUENTIAL OR EXEMPLARY, ARISING OUT OF OR RELATING TO THE PRODUCT;
2. INCONVENIENCE OR ANY LOSS ARISING WHEN IMAGES ARE NOT DISPLAYED, DUE TO ANY REASON OR CAUSE INCLUDING ANY FAILURE OR PROBLEM OF THE PRODUCT;
3. ANY PROBLEM, CONSEQUENTIAL INCONVENIENCE, OR LOSS OR DAMAGE, ARISING OUT OF THE SYSTEM COMBINED WITH THIRD PARTY DEVICES;
4. ANY CLAIM OR ACTION FOR DAMAGES BROUGHT BY ANY PERSON OR ORGANIZATION AS A PHOTOGRAPHED object DUE TO VIOLATION OF PRIVACY CONCERNING A SURVEILLANCE CAMERA'S PICTURE OR SAVED DATA, FOR SOME REASON (INCLUDING USE WHEN USER AUTHENTICATION ON THE AUTHENTICATION SETTING SCREEN IS SET TO OFF), BECOMING PUBLIC OR BEING USED FOR ANY PURPOSE;
5. LOSS OF REGISTERED DATA CAUSED BY ANY FAILURE (INCLUDING INITIALIZATION OF THE PRODUCT DUE TO FORGOTTEN AUTHENTICATION INFORMATION SUCH AS A USER NAME AND PASSWORD).

## Limitation of liability

THIS PUBLICATION IS PROVIDED "AS IS" WITHOUT WARRANTY OF ANY KIND, EITHER EXPRESS OR IMPLIED, INCLUDING BUT NOT LIMITED TO, THE IMPLIED WARRANTIES OF MERCHANTABILITY, FITNESS FOR ANY PARTICULAR PURPOSE, OR NON-INFRINGEMENT OF THE THIRD PARTY'S RIGHT. THIS PUBLICATION COULD INCLUDE TECHNICAL INACCURACIES OR TYPOGRAPHICAL ERRORS. CHANGES ARE ADDED TO THE INFORMATION HEREIN, AT ANY TIME, FOR THE IMPROVEMENTS OF THIS PUBLICATION AND/OR THE CORRESPONDING PRODUCT(S).

## Before using this product

The following cases may cause difficulties in detecting an object or motion, or cause lost or false alarms, or reduced measurement accuracy.

- The background and the moving object are equally bright.
- The video brightness is low (e.g., night scenes).
- The object is moving too fast or too slow.
- The object is too small or too large.
- The light condition is object to change, which can happen outdoors or near windows.
- Sunlight, car headlights, and other outside light lighting up the scene.
- Flickering fluorescent lights.
- Water drops or stains on the camera dome.
- The object is moving directly toward the camera.
- There are too many moving objects.
- The camera is shaking.
- Unfavorable weather conditions.
- More than one human enters the detection area.
- Shadows falling on the detection areas.
- The object is out of focus.
- The object is shaking.
- The object is moving toward or away from the camera at the periphery of the image.
- Only part of an object is visible because it is hidden by a privacy zone or another object. This applies if 2/3 or less of an object is visible.
- There are too many objects (approx. more than 40).
- Multiple objects are intersecting.
- A strong external light has cast a shadow on the object or other areas of the detection area.
- The illumination varies, for example due to a light turning on and off.
- Vehicle signs and posters appearing in the detection area.
- A vehicle is reflected in the windscreen.
- If the vehicle has an XX attached to it (e.g., trailer, boat, etc.)
- The person is lying down or has collapsed.
- The person is short (approx. 120 cm/4 ft or less)

- The person is holding a large piece of baggage. (E.g., pushing a luggage carrier, stroller or wheelchair)
- The person is not walking independently. (E.g., a baby being carried)
- Light conditions are likely to change, such as near a window.
- An animal or an insect appears.
- Posters of human and mannequins appear.
- The camera is not facing downwards.

**NOTE!**

- To prevent false alarms due to disturbances (e.g., shaking trees, roads with moving cars, water surfaces with reflected light, etc.), you can set mask areas (→[2. AI motion detection setting, p. 378](#)).
- When you set up AI-VMD, configure the area setting so that they suit the installation condition of the camera and the expected movement of objects (→[2. AI motion detection setting, p. 378](#)). Then check whether the camera operates as expected during the day and at night.
- False detection may occur for approximately 1 minute after booting the camera, changing the camera settings, or changing the field of view of the camera.
- As long as detectable objects exist on the screen, an alarm occurs at specified intervals. Thus, e-mails and TCP alarms are also sent at the specified intervals (→[Alarm deactivation time, p. 104](#) on the **Alarm** tab of the camera's Setup menu).
- Using AI-VMD will reduce the frame rate of the live video stream.
- MOBOTIX AG shall not be responsible for any inconveniences, losses, or damages caused by the settings of AI-VMD or as a result thereof.
- AI-VMD is not for preventing theft, disaster, etc. MOBOTIX AG shall not bear any liabilities whatsoever for any accidents or losses.

## Configuring AI-VMD

### Configuration workflow

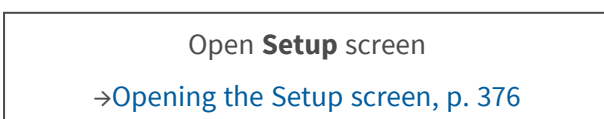

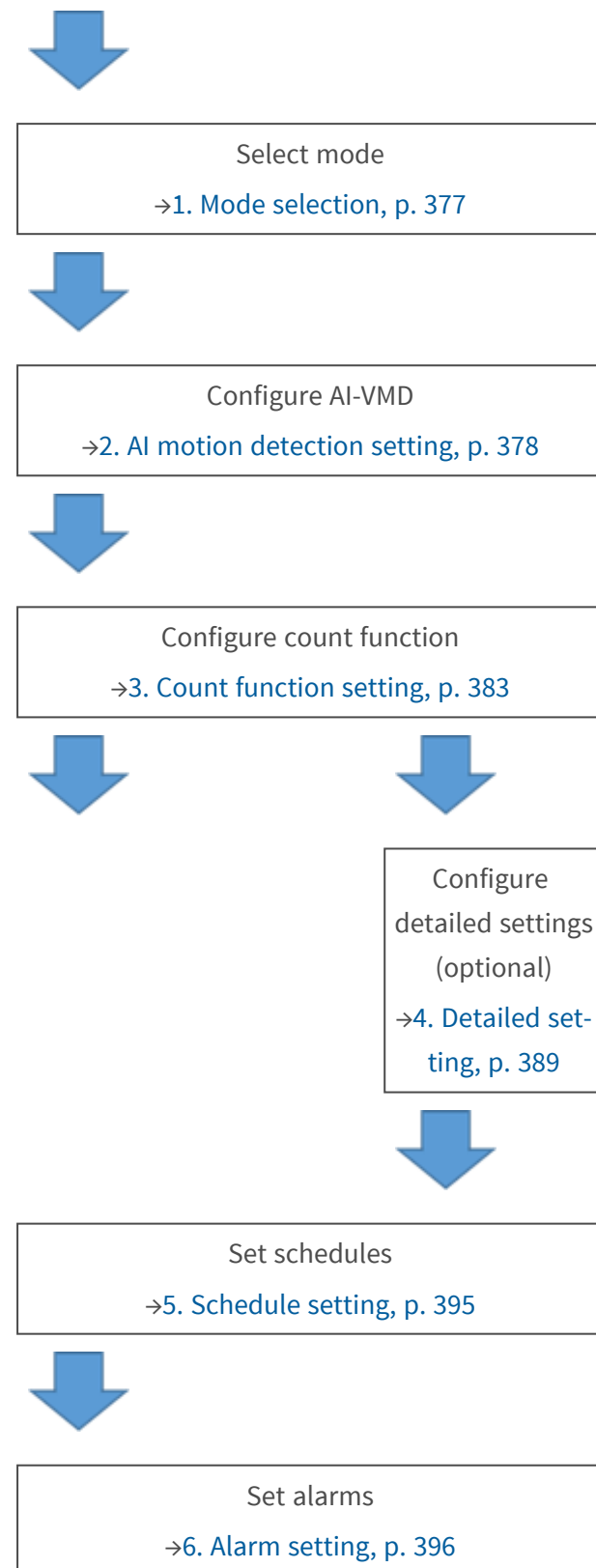

## Opening the Setup screen

The **AI-VMD** menu has been added to the camera's **Setup** menu in **Ext. software > Software mng.**



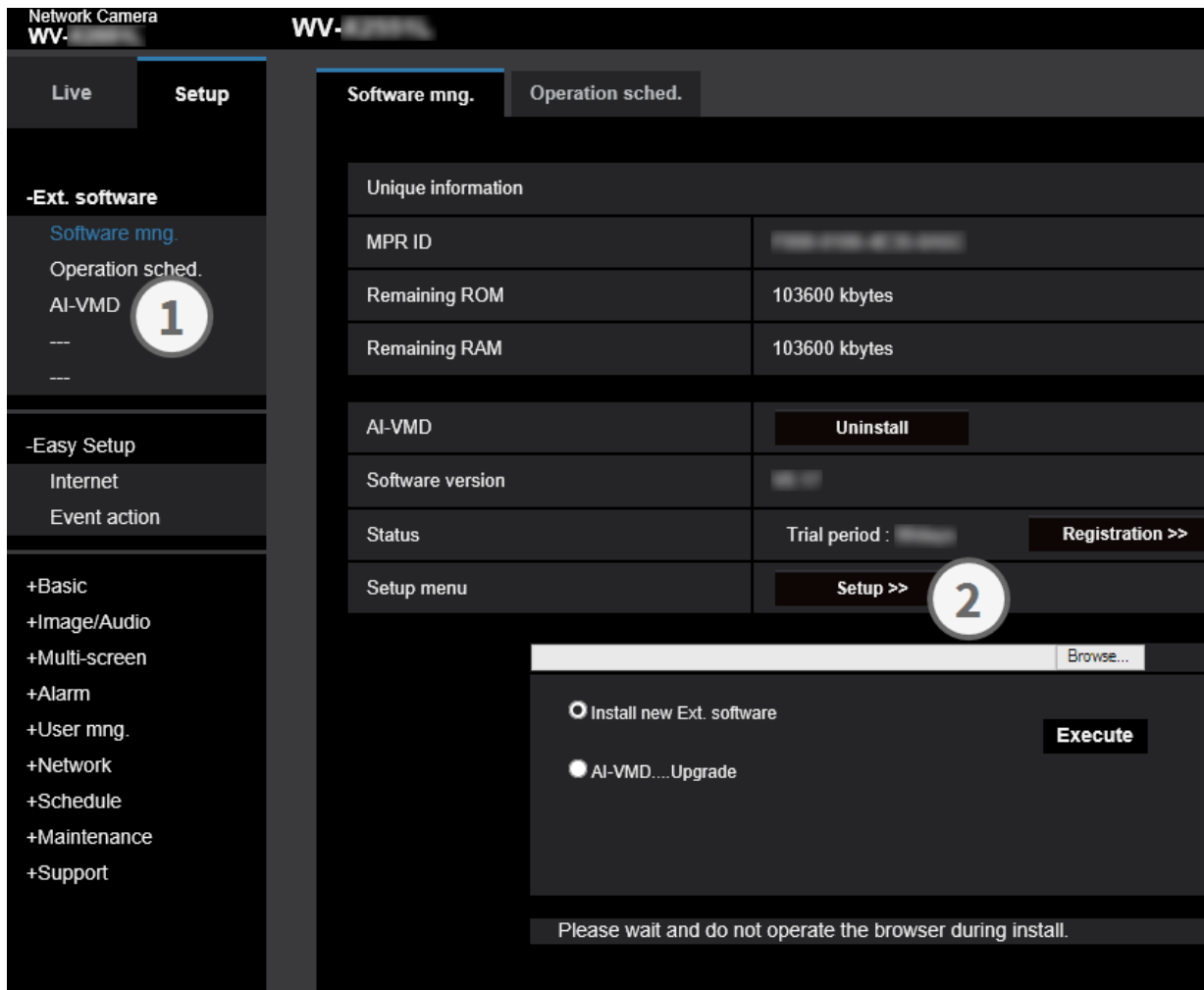

1. Click on **AI-VMD**.
2. Click on **Setup**.

## 1. Mode selection

Select the angle mode you want to use:

- *Normal angle mode*: AI motion detection, count function (for humans, vehicles, two-wheel vehicles).
- *Perpendicular angle mode*: AI motion detection, count function (for humans).



#### NOTE!

- To count human with high accuracy, it is recommended to operate in *Perpendicular angle mode*. However, it is necessary to install the camera facing downwards.
- When using other extension software with this product together in the *Perpendicular angle mode*, carefully read the terms and conditions of using the extension software together with AI-VMD.

## 2. AI motion detection setting

On this screen, you can set the area and conditions with which AI-VMD detects moving objects.

Select the objects in each detection area from humans, vehicles, bicycles. Select the detection mode from INTRUDER, LOITERING, DIRECTION, and CROSS LINE.

- You can define up to eight detection areas and eight mask areas (excluded from detection).
- You can set up to two combinations of areas and detection conditions, which can be saved as "Detection program 1" and "Detection program 2".

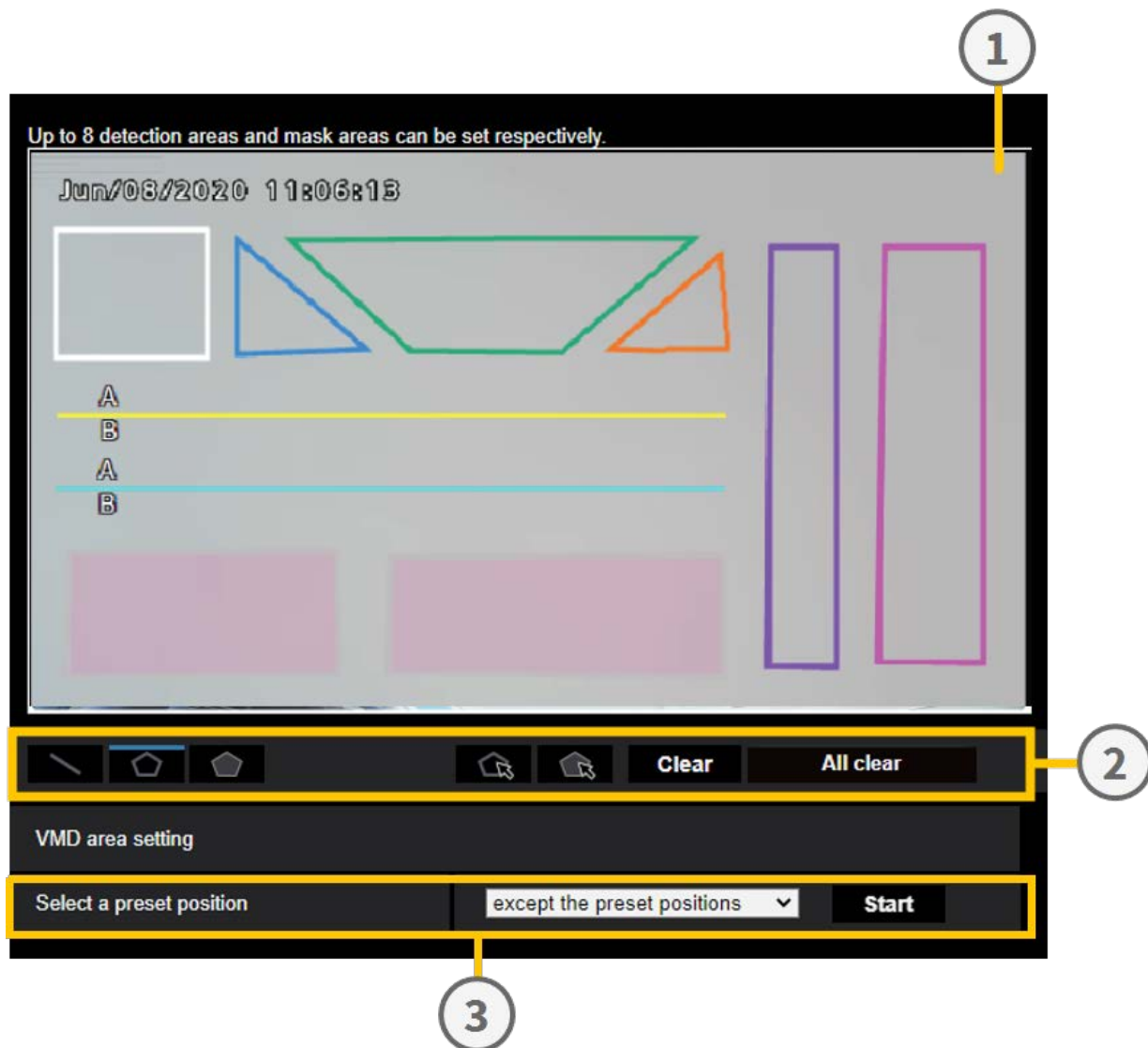







1. Drawing canvas (camera video screen)
2. Drawing tools (lines and shapes)
3. Preset position selector (PTZ cameras only)

## Drawing canvas

- You can draw the detection areas/lines in this area.
- To start drawing, select a drawing tool (->Drawing tools, p. 380), and drag it to the canvas (the camera video screen).
- An alarm occurs when:
  - bodies are detected within the detection areas.
  - bodies are moving across the detection lines.

## Drawing tools

Click on an icon of the line or shape you want to draw and drag it onto the canvas.

-  CROSS LINE: Draw a detection line for CROSS LINE.
-  Detection area (polygon): Draw a detection area as a polygon (with up to 16 sides).
-  Mask area (polygon): Draw a mask area as a polygon (with up to 16 sides).
-  Detection area (select): Select a detection area (detection line) you have drawn.
-  Mask area (select): Select a mask area you have drawn.
-  Clear Clear the selected detection area (detection line) or mask area.
-  All clear Clear all detection areas (detection lines) and mask areas you have drawn.

### NOTE!

- In drawing a detection or a mask area (polygon), you can finish the area setting by selecting the starting point at the end.
- You can change the size, length and shape of detection areas, detection lines or mask areas that you select in "Detection area (select)" or "Mask area (select)" by dragging the corners of the frames or the end points of the lines. Also, you can move them by dragging the inside of frames or lines.
- In clearing detection areas or detection lines, if more than one detection area or detection line is overlapping, clicking the left mouse button in the overlapping areas switches the selected frame in turn.
- For detection frames, the center of the lower edge is regarded as the position of the frame (→[Detection frames \(red, blue\)](#), p. 402). Set the detection area so the position of this frame is in the detection area.
- You cannot select more than one detection area, detection line, or mask area at the same time.
- In the initial setting, the entire canvas is set as the detection area.
- If you change "Image capture mode" or "Image rotation" in the "Setup" menu of the camera, the detection area and mask area settings will return to the default settings.
- The mask area is the same for "Detection setting 1", "Detection setting 2", and the count function.

## Position selection selector (PTZ camera only)

For PTZ cameras, you can define different detection and mask areas as follows.

Select a preset position

except the preset positions
▼

Start

- Preset positions 1 to 16: Allows setting individual detection and mask areas for every position.
- Preset positions 17 to 256: The detection and mask areas are always the same for these positions.

### Start

Click to move to the selected preset position.

**CAUTION!** Alarm notification is OFF while the PTZ camera is moving.

## Setting detection conditions

Detection program 1	Detection program 2				
Detection area	Detection object	<i>i</i>	Detection mode	Direction setup	
1(White)	<input checked="" type="checkbox"/> Human <input checked="" type="checkbox"/> Bicycle	<input checked="" type="checkbox"/> Vehicle	Intruder <span style="font-size: 1em;">▼</span>	Left <span style="font-size: 1em;">▼</span>	
2(Blue)	<input checked="" type="checkbox"/> Human <input checked="" type="checkbox"/> Bicycle	<input checked="" type="checkbox"/> Vehicle	--Not been set-- <span style="font-size: 1em;">▼</span>	Left <span style="font-size: 1em;">▼</span>	
3(Green)	<input checked="" type="checkbox"/> Human <input checked="" type="checkbox"/> Bicycle	<input checked="" type="checkbox"/> Vehicle	--Not been set-- <span style="font-size: 1em;">▼</span>	Left <span style="font-size: 1em;">▼</span>	
4(Red)	<input checked="" type="checkbox"/> Human <input checked="" type="checkbox"/> Bicycle	<input checked="" type="checkbox"/> Vehicle	--Not been set-- <span style="font-size: 1em;">▼</span>	Left <span style="font-size: 1em;">▼</span>	
5(Yellow)	<input checked="" type="checkbox"/> Human <input checked="" type="checkbox"/> Bicycle	<input checked="" type="checkbox"/> Vehicle	--Not been set-- <span style="font-size: 1em;">▼</span>	Left <span style="font-size: 1em;">▼</span>	
6(Light blue)	<input checked="" type="checkbox"/> Human <input checked="" type="checkbox"/> Bicycle	<input checked="" type="checkbox"/> Vehicle	--Not been set-- <span style="font-size: 1em;">▼</span>	Left <span style="font-size: 1em;">▼</span>	
7(Purple)	<input checked="" type="checkbox"/> Human <input checked="" type="checkbox"/> Bicycle	<input checked="" type="checkbox"/> Vehicle	--Not been set-- <span style="font-size: 1em;">▼</span>	Left <span style="font-size: 1em;">▼</span>	
8(Pink)	<input checked="" type="checkbox"/> Human <input checked="" type="checkbox"/> Bicycle	<input checked="" type="checkbox"/> Vehicle	--Not been set-- <span style="font-size: 1em;">▼</span>	Left <span style="font-size: 1em;">▼</span>	

#### Detection program 1/2

Select the "Detection program 1" tab and/or "Detection program 2" tab to set either one or both detection conditions. The two conditions can be executed at the same time or separately depending on the schedule settings (→5. [Schedule setting](#), p. 395).

#### NOTE!

In the initial setting of the schedule, both detection programs are always valid.

#### Detection area

Up to 8 detection areas or lines are distinguished by the color of the drawing lines.

The color of the drawing line shows the order of setting, with "1 (White)" coming first.

#### Detection object

Check the object (moving body) to detect in each detection area.

The following are the 3 types of detection objects.

- Human
- Bicycle (motorcycle, bicycle)
- Vehicle (ordinary car, bus, truck)

Initial setting: Human, bicycle and vehicle are checked

#### NOTE!

- Check all three object types to detect all moving bodies.
- In the case when multiple numbers of detection objects are candidates, the results will be output in the priority sequence of vehicles, bicycles, humans. To improve the results, remove disable detection objects you do need.

For example, in the case of a human standing in front of a vehicle, the human may be output as a vehicle. The human will be detected as a human when disabling the vehicle checkbox.

#### Detection mode

Select the detection mode for each predetermined detection area and detection line.

- INTRUDER: Detects that moving bodies have intruded the detection area (default).
- LOITERING: Detects that moving bodies have loitered in the detection area for the fixed time.
- DIRECTION: Detects that moving bodies have moved in the direction you specified within the detection area.
- CROSS LINE: Detects that moving bodies have crossed the detection line in the direction you specified.

## Direction setup

Set the direction when the detection mode is "DIRECTION" or "CROSS LINE".

For "DIRECTION", you can select from these directions:

- Upper: Detects movement toward the top.
- Upper right: Detects movement toward the top right.
- Right: Detects movement toward the right.
- Lower right: Detects movement toward the bottom right.
- Lower: Detects movement toward the bottom.
- Lower left: Detects movement toward the bottom left.
- Left: Detects movement toward the left (default).
- Upper left: Detects movement toward the top left.

For "CROSS LINE", you can select from these directions:

- $A \rightarrow B$ : Detects movement from A to B.
- $B \rightarrow A$ : Detects movement from B to A (default).
- $A \leftrightarrow B$ : Detects movement from A to B or from B to A.

## Save the settings

Click **Set** to save the currently displayed contents on the **Area** tab.

## Area setting procedure

1. Select the **2. AI motion detection setting** screen.
2. Select the **Detection program 1** tab.
3. Draw detection and mask areas (excluded from detection) on the canvas. You can set up to eight detection areas and eight mask areas.
4. For each detection area, select the detection mode from INTRUDER, LOITERING, DIRECTION, and CROSS LINE.
5. Set **Direction setup** when the detection mode is "DIRECTION" or "CROSS LINE".
6. Click **Set** to save the detection conditions for **Detection program 1**.

Select the **Detection program 2** tab and repeat steps 3 to 6.

## 3. Count function setting

This screen allows configuring the counting function.



1. Drawing canvas (camera video screen)
2. Drawing tools (lines and shapes)
3. Demo screen display
4. Configuration tabs:
  1. Line settings
  2. HTTP transmission
  3. MQTT transmission
  4. Other





### Drawing canvas

- You can draw the detection areas/lines in this area.
- To start drawing, select a drawing tool (→[Drawing tools, p. 384](#)), and drag it to the canvas (the camera video screen).
- An alarm occurs when:
  - bodies are detected within the detection areas.
  - bodies are moving across the detection lines.

### Drawing tools

Click on an icon of the line or shape you want to draw and drag it onto the canvas.



-  CROSS LINE: Draw a detection line for CROSS LINE.
-  Detection area (polygon): Draw a detection area as a polygon (with up to 16 sides).
-  CROSS LINE (select): Select the drawn detection line.
-  Mask area (select): Select a mask area you have drawn.
- **Clear** Clear the selected detection area (detection line) or mask area.
- **All clear** Clear all detection areas (detection lines) and mask areas you have drawn.

## Demo screen display



Click **Execute** to view the demo screen.

## Line settings

### Detection object

For each detection area, select the moving objects moving you want to detect.

The following 3 types of detection objects are available.

- Human
- Vehicle (standard car, bus, truck)
- Two-wheel vehicles (motorcycles and bicycles)

### Default settings

The default settings depend on the selected detection mode (→[1. Mode selection, p. 377](#)).

- *Perpendicular angle mode*: Humans
- *Normal angle mode*: Vehicles

#### NOTE!

The detectable objects also vary depending on the selected detection mode (→[1. Mode selection, p. 377](#)).

- *Perpendicular angle mode*: Humans
- *Normal angle mode*: Humans, vehicles, two-wheel vehicles

### Direction setup

Specify the direction for counting.

## Appendix

### AI-VMD for object detection and counting

---

- Inward
- Outward
- In/Outward (default)

#### Detection line name

Set a name up to 20 characters for each area.

Default setting: Line 1~8

Unavailable characters: Half-width symbols "" "" "&"

#### Save the settings

Click **Set** to save the currently displayed contents on the **Area** tab.

#### HTTP transmission

Set the transmission interval and the destination to which count data will be sent via HTTP. You can set up to four different destinations.

The screenshot shows a configuration window with four tabs: "Line", "HTTP transmission" (selected), "MQTT transmission", and "Other". Below the tabs, there is a text block: "Count information can be transmitted to an external server via HTTP. Refer to the external interface specification document for HTTP transmission information." Below this, there is a section for "Transmission destination 1" with a "Transmission" checkbox (unchecked). The fields include: "Destination address" with a "Delete" button; "Destination path name" with a "Delete" button; "SSL" with radio buttons for "On" (selected) and "Off"; "Destination port number" with a value of "443" and a note "(1-65535)"; "User name" and "Password" with empty text input fields; and "Transmission interval" with a dropdown menu showing "5min".

#### Transmission destination 1 to 4

Count data can be notified individually in up to 4 locations. The setting for the 4 transmission destinations are the same.

#### Transmission

Enable this checkbox to send messages to this destination (unchecked by default).

**Destination address**

Enter the IP address of the transmission destination (excluding 0 . 0 . 0 . 0).

**Destination path name**

Enter the path name of the transmission destination (single-byte alphanumeric or symbols up to 128 characters).

**SSL**

Uses SSL (*Secure Socket Layer*) for encrypted transmission (enabled by default).

**Destination port number**

Enter the port of the transmission destination (1 ~ 65535).

**User name**

Enter the user name for authentication at the destination (single-byte alphanumeric or symbols up to 128 characters).

**Password**

Enter the password for authentication at the destination (single-byte alphanumeric or symbols up to 63 characters).

**Transmission interval**

Select the time interval between transmissions.

## MQTT transmission

Count information can be transmitted to an external server via MQTT.  
Refer to the external interface specification document for MQTT payload.

Transmission destination  Transmission [To MQTT transmission setting](#)

Topic

QoS 0   Retain

Transmission interval 5min

\* Perform the settings of the following items on the MQTT setup menu of the camera.

- Camera's MQTT transmission On/Off
- Server setting (Address, port, protocol, user name, password)
- Root CA certificate (Install, enable/disable server certificate verification)

Set the transmission content and transmission interval for count data transmission via MQTT.

### Transmission

Enable this checkbox to send messages to this destination (unchecked by default).

### To MQTT transmission setting

Click to display the MQTT setting screen of the camera.

### Topic

Enter the name of the MQTT topic (single-byte alphanumeric or symbols up to 128 characters).

### QoS

Select the QoS level (*Quality of Service*). Communication quality is higher with  $0 < 1 < 2$ .

- 0: Messages are delivered at most once. There is no guarantee that the message will reach the server.
- 1: Messages are delivered at least once (default). It is assured that the message will reach its destination, but it may be duplicated.
- 2: Messages are delivered exactly once. It is assured that the message will arrive exactly once.

## Retain

Enable this checkbox to have the last notified message stored on the MQTT server (unchecked by default).

## Transmission interval

Select the time interval between transmissions.

## Other

### Count data storage interval

Set the measurement interval of counting data (a new file will be created when starting a new interval).

- The storage time for count data is 92 days\*.  
\*Data will be stored longer than the above storage time depending on the camera's time zone setting (maximum 23 hours).  
Example: If the time zone is +9.00, count data will be stored for 92 days + 9 hours.
- The counting function does not support HTTPS connections.

### The interval for the transmission of ONVIF®

Select the time interval between transmissions of ONVIF metadata.

Default: 15 s

## 4. Detailed setting

On this screen, you can set the the detection sensitivity, detection time, and the size of humans to detect with AI-VMD.

AI-VMD setup menu | 1. Mode selection > 2. AI motion detection setting > 3. Count function setting > 4. Detailed setting > 5. Schedule setting > 6. Alarm setting

**Detailed setting**

AI-VMD alarm

- An alarm is issued only when a motion is detected for the first time
- An alarm is issued every time a motion is detected

**Threshold setting**

Motion detection threshold	5	Reset
Human identification threshold	20	Reset
Vehicle identification threshold	70	Reset
Bicycle identification threshold	55	Reset

**Time setting**

Intruder detection time	1s
Loitering detection time	10s
Direction detection time	1s

Depth: [Setup >>](#)

AI-VMD Information addition: [On \(with live display\)](#)

Additional information type: [With detected object information \(alarm frame information\)](#)

Judgement of movement distance: [Middle](#)

[Set](#) [Setting data initialization](#)

## Image quality setting

Click **Execute** to automatically set the appropriate image quality for AI-VMD with one click.

- Super Dynamic: Off
- Light control speed 8
- White balance adjustment speed: 8 Digital noise reduction 128
- Intelligent auto: Off
- Auto contrast adjust: Off

### CAUTION!

If you select values larger than "Max. 1/30s" on **Image adjust - Light control mode - Maximum shutter**, the reliability of detection may decrease.

## AI-VMD Alarm notification operation setting

Sets notification behavior for when alarm notification conditions are met.

- An alarm is issued only when a motion is detected for the first time: Notification the first time the alarm conditions are met only.
- An alarm is issued every time a motion is detected: Notification continuously as long as alarm conditions are met (default).

## Threshold setting

Configures the thresholds of AI-VMD. This setting applies to all detection conditions.

**Motion detection threshold**

Set the detection threshold for the movement of the object to detect. This setting applies to the detection threshold for all objects. Lower values increase detection probability, but can result in more false alarms.

**Human identification threshold**

Set the detection threshold for detecting humans. Lower values increase detection probability, but can result in more false alarms.

**Vehicle identification threshold**

Set the detection threshold for detecting vehicles. Lower values increase detection probability, but can result in more false alarms.

**Bicycle identification threshold**

Set the detection threshold for detecting bicycles. Lower values increase detection probability, but can result in more false alarms.

**Time setting**

Configures how long a situation must be detected before triggering alarms.

**Intruder detection time**

Set the time how long an intrusion must be observed before triggering an alarm.

Initial setting: 1 s

**Loitering detection time**

Set the time how long loitering must be observed before triggering an alarm.

Initial setting: 10 s

**Direction detection time**

Set the time how long an object must be observed before triggering an alarm.

Initial setting: 1 s

**NOTE!** Depending on the movement of objects and other factors, an alarm may not trigger since the time is too short. It is recommended to test this feature and to increase the detection time in such a case.





**Depth**

The depth setting allows filtering objects detected as "humans" by height; "humans" that are too short will not trigger an alarm.

The depth setting applies to both *Detection program 1* and *Detection program 2*.

## Depth setting

Click **Setup** >> to display the **Depth setting** screen shown below.

Depth setting 		On <input type="checkbox"/> <input checked="" type="checkbox"/> Use "inch" as unit
Marker 1 	Photographic subject size	160 cm(100-200cm) *160cm = 63inch
	Clear	
Marker 2 	Photographic subject size	160 cm(100-200cm) *160cm = 63inch
	Clear	
Size setting		
Max. size 	300 %	
Min. size	50 %	

Activate the depth setting.

- On: Manually set the depth to use by the camera.
- Off: Depth is not used (default).

**NOTE!** If detecting humans often fails with activated **Depth setting**, try to deactivate this setting.

### Use "inch" as unit

If checked, centimeters will change to inches (off by default).

### Size setting

When the depth setting is enabled, only the humans detected with sizes between the maximum and the minimum sizes trigger alarms.

Set the maximum and minimum size using a person of 160 cm (63 inches) in height as the reference size (100%).

#### Max. size

Set the maximum size of humans to detect.

Initial setting: 300%



### Min. size

Set the minimum size of humans to detect.

Initial setting: 50%

### Setting depth procedure

Draw marker 1 and marker 2 in two positions on the canvas.

Then, enter each "object size" for marker 1 (white) and marker 2 (blue).

Click **Clear** to clear the drawn marker.

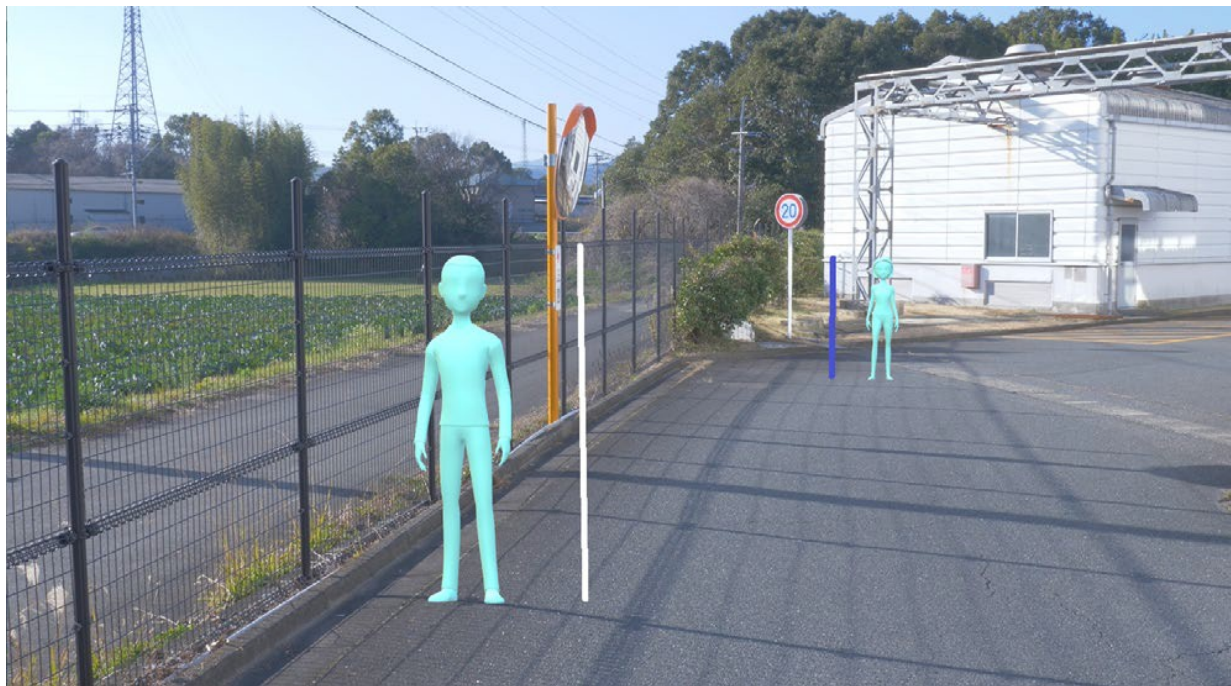

Fig. 3: Example of setting the depth markers

#### NOTE!

- Enter the "object size" (height) between 100 cm and 200 cm. Draw straight line markers where the actual heights occupy.
- Draw the markers at two different positions in the canvas, one in front and one in the back. If the two markers are too close together, depth may not be set properly.

#### EXAMPLE:

Marker 1 size: 160 cm

Marker 2 size: 160 cm

Max. size: 150%

Min. size: 30%.

People between 48 cm ( $160 \times 30\%$ ) and 240 cm ( $160 \times 150\%$ ) will trigger an alarm.

## Select a preset position (PTZ camera only)

For PTZ cameras, the depth and size settings can be set for each preset position.

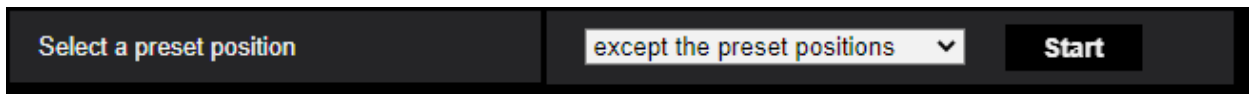

- Preset positions 1 to 16: Allows setting individual depth and size settings for every position.
- Preset positions 17 to 256: The depth and size settings are always the same for these positions.

## AI-VMD information addition

This section allows adding AI-VMD information (detection frames and types of detection objects) to the video data. You can also display detection frames and tracks in the live video in the web browser. If you set this option to *On (with live display with blue frame)*, a blue frame will highlight moving objects on the screen. The color of the frame turns red when the object intrudes the detection area and triggers an alarm. Also, the track of the object is displayed in green for about the last 3 seconds.

- *Off*: AI-VMD information is not added. Neither detection frames nor tracks are displayed.
- *On*: AI-VMD information is added, but detection frames and tracks are not displayed.
- *On (with live display)*: AI-VMD information is added, detection frames and tracks are displayed, but the blue frame is not displayed (default).
- *On (with live display with blue frame)*: AI-VMD information is added, the detection frame and tracks are displayed. In addition to the red frame, the blue frame is displayed.

**NOTE!** The setting of AI-VMD information addition does not affect the operation of alarms.

## Additional information type

This section allows adding information to the video data and the type of frames displayed in the live video of the web browser.

- *With detected object information (alarm frame information)*: Adds information about detected objects (humans, vehicles, bicycles) and position information about alarm frames (red frame), VMD (*Video Motion Detection*) frames (blue frame). This is the default setting.
- *With detected object information (AI frame information)*: Adds information about detected objects (humans, vehicles, bicycles) and the position information about AI frames (green frame) which are detected by AI.
- *Without detected object information*: Adds only the position information about the alarm frame (red frame) and VMD frames (blue frame). The information about detection objects (humans, vehicles, bicycles) is not added.

## Set

Click to save the currently displayed contents of this screen.

## Setting data initialization

Click to reset all settings of AI-VMD.

## Alarm alert condition

Set the conditions under which an alarm is issued.

## Movement amount judgment

You can set the alarm threshold for moving objects.

- *Off*: The alarm will be triggered by tiny movements of the object.
- *Low*: The alarm will be triggered by small movements of the object.
- *Middle*: Default
- *High*: The alarm will be triggered by large movements of the object.

**NOTE!** “Off” and “Low” can be useful in scenes where the object moves from the back to the front and the camera tilt angle is shallow. “High” can be useful to reduce the number of false positive alarms caused by slight movements.

## 5. Schedule setting

By default, the schedules of both *Detection setting 1* and *Detection setting 2* are always active (24/7).

To change the schedules, see →[Using schedules](#), p. 345.

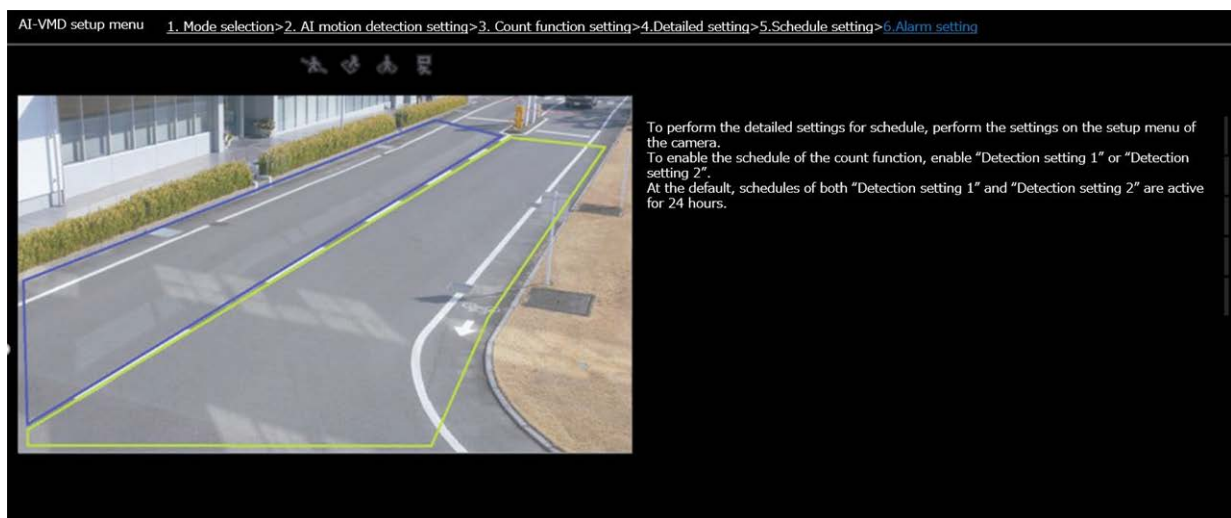

## 6. Alarm setting

This screen allows setting the camera actions when detecting objects.

To configure the basic alarm notifications, see →[Configuring alarm notifications, p. 287](#), →[Advanced network settings, p. 314](#) and →[MxMessageSystem settings, p. 341](#).

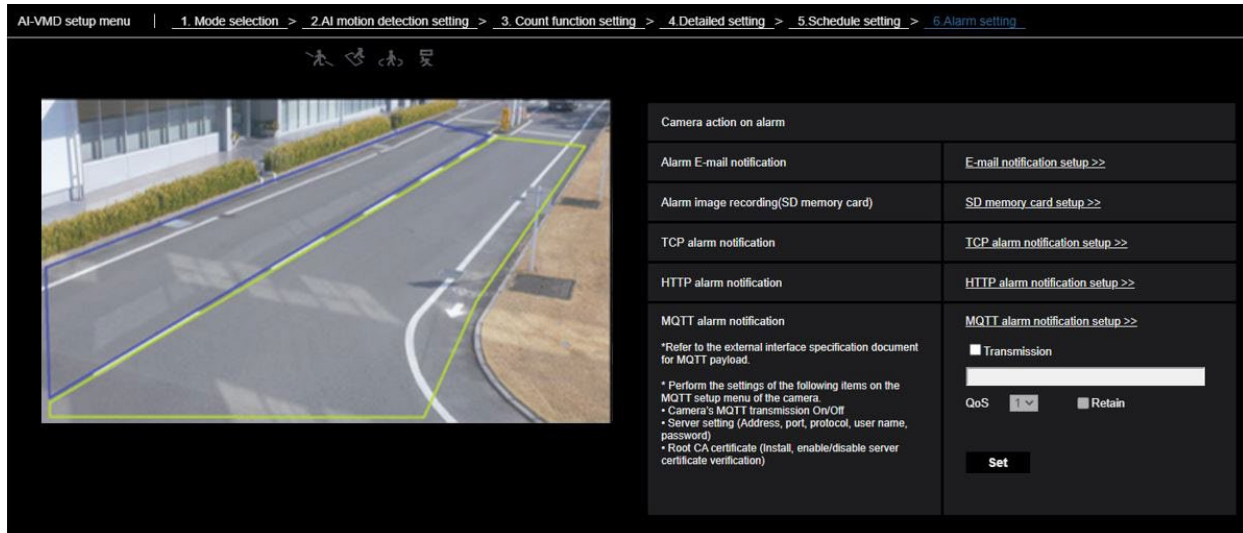

### Alarm E-mail notification

Click on **E-mail notification setup** to configure e-mail alarm notifications.

### Alarm image recording (SD memory card)

Click on **SD memory card setup** to configure alarm SD card recordings.

### TCP alarm notification

Click on **TCP alarm notification setup** to configure TCP alarm notifications.

### HTTP alarm notification

Click on **HTTP alarm notification setup** to configure HTTP alarm notifications.

### MQTT alarm notification

Click on **MQTT alarm notification setup** to configure MQTT alarm notifications.

#### Transmission

Activate this checkbox to send MQTT messages (disabled by default).

#### Topic

Enter the name of the MQTT topic (single-byte alphanumeric or symbols up to 128 characters).

## QoS

Select the QoS level (*Quality of Service*). Communication quality is higher with  $0 < 1 < 2$ .

- 0: Messages are delivered at most once. There is no guarantee that the message will reach the server.
- 1: Messages are delivered at least once (default). It is assured that the message will reach its destination, but it may be duplicated.
- 2: Messages are delivered exactly once. It is assured that the message will arrive exactly once.

## Retain

Enable this checkbox to have the last notified message stored on the MQTT server (unchecked by default).

## Demo screen

Both, AI-VMD and the Count function have a demo screen display button. Click the button to start the corresponding demo.

## AI-VMD

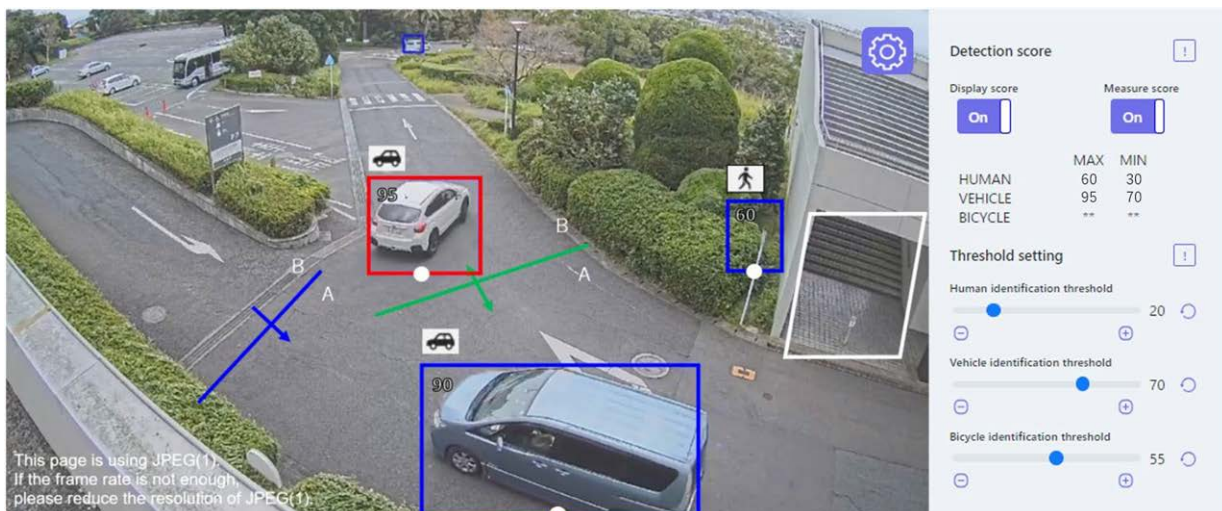

The screenshot displays a street scene with several vehicles and a pedestrian. A white car is highlighted with a red bounding box and a score of 95. A blue car is highlighted with a blue bounding box and a score of 90. A pedestrian is highlighted with a blue bounding box and a score of 60. The interface includes a settings panel on the right with the following data:

Detection score	
Display score	Measure score
<input checked="" type="checkbox"/>	<input checked="" type="checkbox"/>
HUMAN	MAX 60 MIN 30
VEHICLE	95 70
BICYCLE	** **

Threshold setting	
Human identification threshold	20
Vehicle identification threshold	70
Bicycle identification threshold	55

Additional text in the bottom left corner: "This page is using JPEG(1). If the frame rate is not enough, please reduce the resolution of JPEG(1)."

## Detection area

The detection areas are displayed as follows:

- Detection areas
  - Area 1: White
  - Area 2: Blue
  - Area 3: Green
  - Area 4: Red
  - Area 5: Yellow
  - Area 6: Light blue
  - Area 7: Purple
  - Area 8: Pink
- Lines
  - Solid line: Line set to “On”
  - Dashed line: Line set to “Off”

## Direction label

Displays the direction labels for Cross Line Detection and Count functions (Cross Line Detection: A, B; Count function: In, Out).

## Detection frame

A frame is displayed when a target object is detected.

- Red frame: Displays the objects in the area where the alarm occurred and objects crossing the line in the set directions.
- Blue frame: Displays the detected object.

## White dots in detection frame

The white dot in the person detection frame shows the position of the person's feet.

## Count function

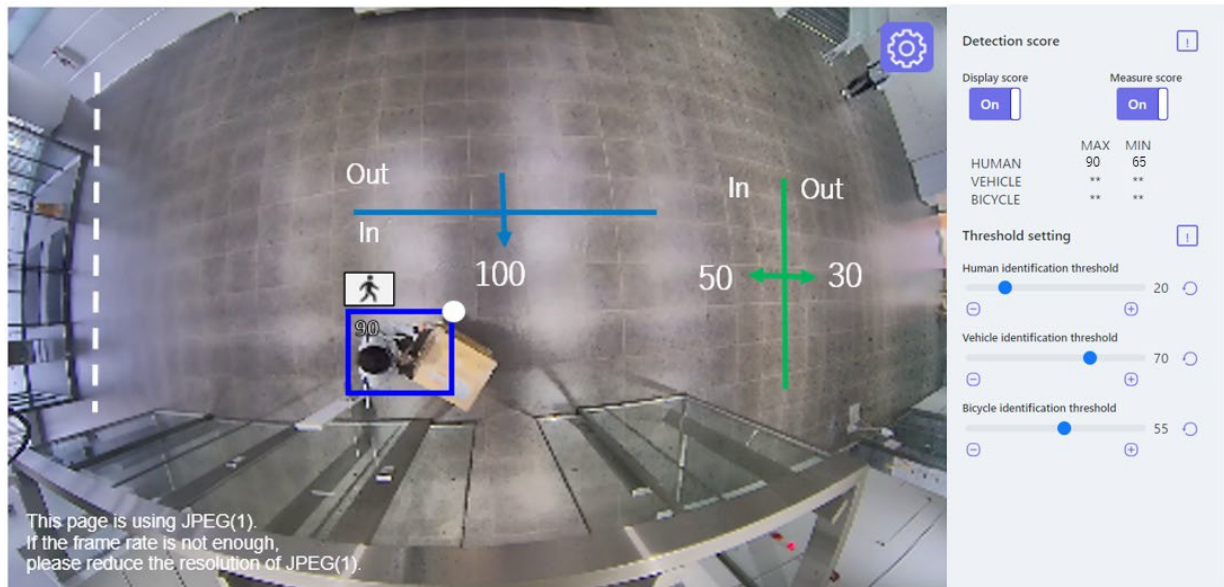

### Number of counts (Count function only)

The count for target objects counted in the set direction is displayed in a color that corresponds to the line being counted.

Line 1: White; Line 2: Blue; Line 3: Green; Line 4: Red; Line 5: Yellow; Line 6: Light blue; Line 7: Purple;

Line 8: Pink

### Settings button

Click to display the **Display score** and **Measure score** toggle switch and threshold settings.

#### Display score

When the switch is "On", the Display score is displayed in the upper left corner of the detection frame.

A detection score below the threshold shows as "\*\*\*".

#### Measure score

When set to "On", measures the maximum and minimum detection scores and shows the results (MAX/MIN) on the demo screen.



#### Icon

When the Display score is "On", the icon of the detection object is displayed on the upper left of the detection frame.

## Appendix

### AI-VMD for object detection and counting

---

- Human: 
- Vehicle: 
- Two-wheel vehicles: 

#### NOTE!

- Please use Mozilla Firefox, Google™ Chrome™ or Microsoft Edge to display the demo screen. Internet Explorer is not supported.
- The demo screen can be displayed on only one browser. It does not support simultaneous access by multiple browsers. It also does not support a simultaneous display of both demo screens for the AI-VMD and the Count function.
- If data encryption is "On", the demo screen image will not be displayed.
- The demo screen does not support HTTPS connections.
- When used simultaneously with other extension software functions, the position of the person may be significantly misaligned with the detection frame on the demo screen.
- The demo screen is for demo purposes only; it is **not** to be used for live operation.
- If **Display score** is deactivated, **Measure score** cannot be activated.

## Using AI-VMD

Once you have finished configuring AI-VMD (→[Configuring AI-VMD, p. 375](#)), open the web browser of the camera to display the video and start using the software.



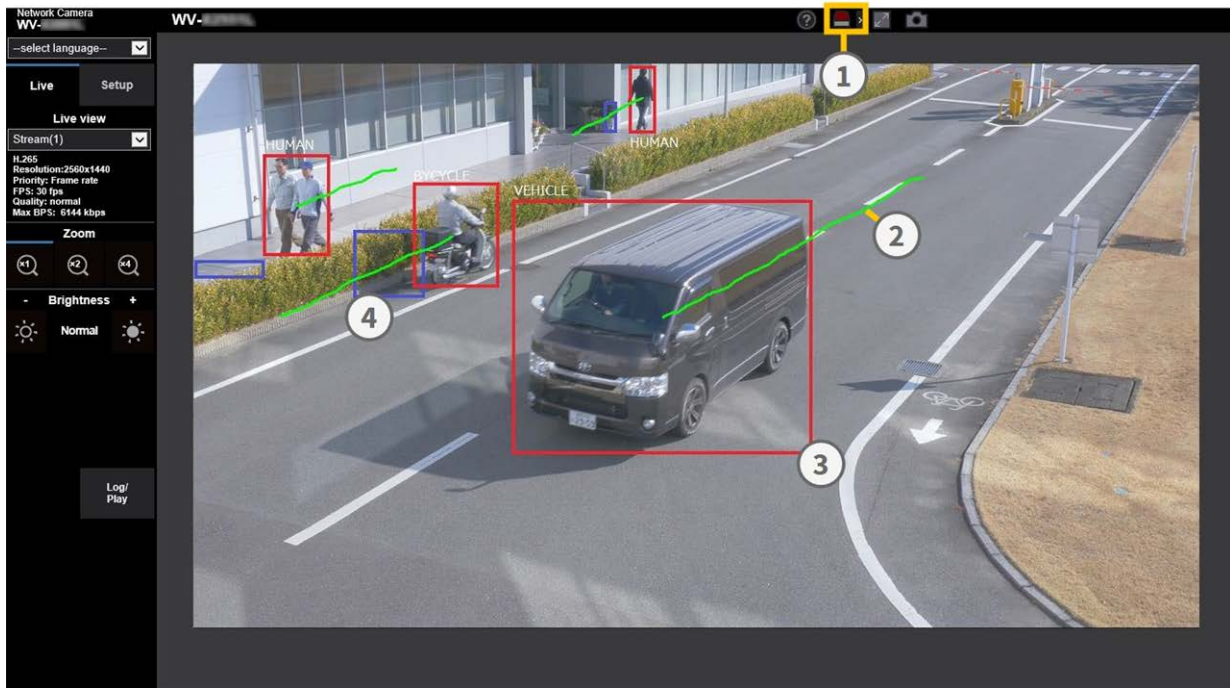

1. Alarm icons
2. Track
3. Red detection frame
4. Blue detection frame

## Alarm icons



When AI-VMD detects moving bodies, the alarm icon and the icons for detection modes light up. Click the alarm icon to clear the alarm state and turn off all the icons.

Click > to the right of the button to show the alarm status for each detection mode.

-  ALARM
-  CROSS LINE
-  INTRUDER
-  LOITERING
-  DIRECTION

A red frame is added to the icon of the corresponding detection mode when an alarm occurs. In addition, the details of the alarm are described to the right of the icon.

Click < to hide the icon for each detection mode.

## Detection frames (red, blue)

When a moving object is detected, a blue frame appears around the body. When the object enters a detection area and triggers an alarm, the frame turns red.

The frame display can be turned On/Off (→[AI-VMD information addition, p. 394](#)).

## Track

The track of an alarm frame (red) is displayed in green; it tracks approx. the last 3 seconds of object movement.

It is displayed when the alarm frame (red frame) is set to be displayed in the settings of →[AI-VMD information addition, p. 394](#) and →[Additional information type, p. 394](#).

### CAUTION!

- If you change **Image/Audio > Image capture mode** or **Basic > Image rotation** in the camera setup menu after setting the detection areas of AI-VMD, then the detection areas, mask areas, and the depth may be shifted or initialized. After changing **Image capture mode** or **Image rotation**, check the detection area setting, mask area setting, and depth setting again.
- If you change the zoom setting after setting the detection areas of AI-VMD, the detection areas and the mask areas may shift. After changing the zoom setting, check the detection area setting, mask area setting, and depth settings again.

**NOTE!** The alarm icon also lights up when an alarm input or a command alarm is received at a terminal alarm.

## Open Source Software Licenses

### MIT License (MIT)

Copyright (c) 2015 Andrew Putilov

Permission is hereby granted, free of charge, to any person obtaining a copy of this software and associated documentation files (the "Software"), to deal in the Software without restriction, including without limitation the rights to use, copy, modify, merge, publish, distribute, sublicense, and/or sell copies of the Software, and to permit persons to whom the Software is furnished to do so, subject to the following conditions:

The above copyright notice and this permission notice shall be included in all copies or substantial portions of the Software.

THE SOFTWARE IS PROVIDED "AS IS", WITHOUT WARRANTY OF ANY KIND, EXPRESS OR IMPLIED, INCLUDING BUT NOT LIMITED TO THE WARRANTIES OF MERCHANTABILITY, FITNESS FOR A PARTICULAR PURPOSE AND NONINFRINGEMENT. IN NO EVENT SHALL THE AUTHORS OR COPYRIGHT HOLDERS BE LIABLE FOR ANY CLAIM, DAMAGES OR OTHER LIABILITY, WHETHER IN AN ACTION OF CONTRACT, TORT OR OTHERWISE, ARISING FROM, OUT OF OR IN CONNECTION WITH THE SOFTWARE OR THE USE OR OTHER DEALINGS IN THE SOFTWARE.

## **License Agreement For Open Source Computer Vision Library (3-clause BSD License)**

By downloading, copying, installing or using the software you agree to this license.

If you do not agree to this license, do not download, install, copy or use the software.

Copyright (C) 2000-2020, Intel Corporation, all rights reserved. Copyright (C) 2009-2011, Willow Garage Inc., all rights reserved. Copyright (C) 2009-2016, NVIDIA Corporation, all rights reserved.

Copyright (C) 2010-2013, Advanced Micro Devices, Inc., all rights reserved. Copyright (C) 2015-2016, OpenCV Foundation, all rights reserved.

Copyright (C) 2015-2016, Itseez Inc., all rights reserved. Copyright (C) 2019-2020, Xperience AI, all rights reserved. Third party copyrights are property of their respective owners.

Redistribution and use in source and binary forms, with or without modification, are permitted provided that the following conditions are met:

- Redistributions of source code must retain the above copyright notice, this list of conditions and the following disclaimer.
- Redistributions in binary form must reproduce the above copyright notice, this list of conditions and the following disclaimer in the documentation and/or other materials provided with the distribution.

- Neither the names of the copyright holders nor the names of the contributors may be used to endorse or promote products derived from this software without specific prior written permission.

This software is provided by the copyright holders and contributors "as is" and any express or implied warranties, including, but not limited to, the implied warranties of merchantability and fitness for a particular purpose are disclaimed.

In no event shall copyright holders or contributors be liable for any direct, indirect, incidental, special, exemplary, or consequential damages (including, but not limited to, procurement of substitute goods or services; loss of use, data, or profits; or business interruption) however caused and on any theory of liability, whether in contract, strict liability, or tort (including negligence or otherwise) arising in any way out of the use of this software, even if advised of the possibility of such damage.

## Independent JPEG Group

This software is based in part on the work of the Independent JPEG Group.

Redistribution and use in source and binary forms, with or without modification, are permitted provided that the following conditions are met:

- Redistributions of source code must retain the above copyright notice, this list of conditions and the following disclaimer.
- Redistributions in binary form must reproduce the above copyright notice, this list of conditions and the following disclaimer in the documentation and/or other materials provided with the distribution.
- Neither the name of the libjpeg-turbo Project nor the names of its contributors may be used to endorse or promote products derived from this software without specific prior written permission.

THIS SOFTWARE IS PROVIDED BY THE COPYRIGHT HOLDERS AND CONTRIBUTORS "AS IS", AND ANY EXPRESS OR IMPLIED WARRANTIES, INCLUDING, BUT NOT LIMITED TO, THE IMPLIED WARRANTIES OF MERCHANTABILITY AND FITNESS FOR A PARTICULAR PURPOSE ARE DISCLAIMED. IN NO EVENT SHALL THE COPYRIGHT HOLDERS OR CONTRIBUTORS BE LIABLE FOR ANY DIRECT, INDIRECT, INCIDENTAL, SPECIAL, EXEMPLARY, OR CONSEQUENTIAL DAMAGES (INCLUDING, BUT NOT LIMITED TO, PROCUREMENT OF SUBSTITUTE GOODS OR SERVICES; LOSS OF USE, DATA, OR PROFITS; OR BUSINESS INTERRUPTION) HOWEVER CAUSED AND ON ANY THEORY OF LIABILITY, WHETHER IN CONTRACT, STRICT LIABILITY, OR TORT (INCLUDING NEGLIGENCE OR OTHERWISE) ARISING IN ANY WAY OUT OF THE USE OF THIS SOFTWARE, EVEN IF ADVISED OF THE POSSIBILITY OF SUCH DAMAGE.

# System log explanations

## SMTP

Classification	Description	Explanation/Remarks
POP3 server error	Authentication error	The username and password may be incorrect. Check the mail settings again.
	Without finding a POP3 server	The IP address of the server may be incorrect. Reconfirm the server's IP address setting. The POP3 server may be down. Contact your network administrator.
SMTP server error	SMTP authentication error	The username and password may be incorrect. Check the mail settings again.
	Failure to resolve mail server address from DNS	The DNS server might be specified incorrectly. Check the DNS settings again. The DNS server might be down. Contact your network administrator.
	Without finding the SMTP server	The IP address of the server may be incorrect. Reconfirm the server's IP address setting. The SMTP server might be down. Contact your network administrator.
Internal error	Other errors	There is a problem with the mail function. Check the mail settings again.

## Visual.Net

Classification	Description	Explanation/Remarks
Access test error	Access test failed	The router might not be configured for port forwarding. Enable the UPnP configuration by referring to your

## Appendix

### System log explanations

---

		router's instruction manual.
Visual server error	Net server address cannot be resolved from DNS.	The DNS server might be specified incorrectly. Check the DNS settings again. The DNS server might be down.
Connection failure	No server response Transfer error	The server may appear to be down.
Internal error	Other errors	It looks like you have a problem with the .Net function. Please try reinstalling the Visual .Net redistributable.

---

## Dynamic DNS update

Classification	Description	Explanation/Remarks
DDNS server error	Cannot resolve DDNS server address from DNS	The DNS server might be specified incorrectly. Check the DNS settings again. The DNS server might be down. Contact your network administrator.
Connection failure	No server response Host registration with homonyms	The DDNS server might be down. Contact the server administrator. Hosts with the same name are registered on the DDNS server. Reaffirm the DDNS Update setting.
Internal error	Other errors	A problem with the DDNS Update function has occurred. Reaffirm the DDNS Update setting.

## NTP

Classification	Description	Explanation/Remarks
Connection failure	No server response	The IP address of the server may be incorrect. Reaffirm the server's IP address setting. The NTP server may be down. Contact the server administrator.
Internal error	Other errors	Problems with the NTP function are occurring. Reaffirm

---

the NTP settings.

Time synchronization suc- Auto time cor- Successful time adjustment.  
cess with NTP rection

## HTTPS

Classification	Description	Details of contents
HTTPS	Generated signature request	The creation of the signature request was completed.
	CA certificate installed	The CA certificate installation is completed.
	CA certificate deleted	The CA certificate has been deleted.
	Previous CRT keys applied	Previous CRT keys were applied as CRT keys.
	CRT key generated	CRT key generation completed.

## MQTT

Classification	Description	Details of contents
MQTT	Connection failure	Failure to connect to the server, fail to validate the certificate, or disconnect (except for disconnection from the camera due to configuration changes)
	Notification error	If Publish to the server fails

## Login

Classification	Description	Details of contents
Login	User name or IP address	Displays the user name of the user logged in to the camera when user authentication is configured. Displays the IP address of the user logged in to the camera when host authentication is configured.
	Login failure	User name Displays the user name of the user who failed to log in to the camera when user authentication is configured.

If the user is not registered, the (unregistered user) is displayed.

The log for **Login failed** may remain during normal operation, but this is not an error in the camera.

If a large number of consecutive logs are retained, unauthorized access may be obtained. Contact your network administrator.

## Unique alarm notification

Classification	Description	Explanation/Remarks
Original alarm notification destination error	Without notifying	The IP address of the notification destination may be incorrect. Confirm the setting of the IP address of the notification destination.  The notification destination may be down. Contact your network administrator.
	Notification address cannot be resolved from DNS.	The DNS server might be specified incorrectly. Check the DNS settings again.  The DNS server might be down. Contact your network administrator.

## HTTP alarm notification

Classification	Description	Explanation/Remarks
HTTP alarm notification destination error	Without notifying	The IP address of the notification destination may be incorrect. Confirm the setting of the IP address of the notification destination.  The notification destination may be down. Contact your network administrator.
	Notification address cannot be resolved from DNS.	The DNS server might be specified incorrectly. Check the DNS settings again.  The DNS server might be down. Contact your network administrator.
	Authentication error	The username and password may be incorrect. Check whether the HTTP alarm is set correctly.



## SD card security

Classification	Description	Details of contents
SD card	Generated signature request	The creation of the signature request was completed.
	CA certificate installed	The CA certificate installation is completed.
	CA certificate deleted	The CA certificate has been deleted.
	Previous CRT keys applied	Previous CRT keys were applied as CRT keys.
	CRT key generated	CRT key generation completed.

---

## Firmware upgrade

Classification	Description	Details of contents
Upgrading the firmware	Successful version upgrade	The firmware version is successfully upgraded and the firmware version (before/after) is logged.
	Version upgrading failed (timeout: insufficient communication bandwidth)	Farm-up failed due to timeout from insufficient communication bandwidth. Confirm the communication environment and perform the procedure again.
	Failed version upgrading (file error: Incorrect firmware file selection)	Farm-up failed because the wrong file was uploaded. Select the firmware of the camera and perform the test again.
	Version upgrading failure (Communication error: File corrupted)	Firmup failed due to file corruption during firmware transfer. Confirm the communication environment and perform the procedure again.
	Version upgrade failure (Other error)	Error occurred during firmware version upgrade. Wait for a while before starting the procedure again.

---

## Installation status

Classification	Description	Details of contents
Installation status	Installation status error	Error in installation was detected. Reaffirm the installation condition of the machine and turn on the power again.

---

## FTP/SFTP

Classification	Description	Details of contents
Server error	Can't find a server	The FTP/SFTP server might be down. Contact the server administrator.
	Failure to resolve FTP server address from DNS	The IP address of the FTP/SFTP server may be incorrect. Reaffirm the server's IP address setting.
Connection failure	Username password error	The FTP/SFTP server may be configured incorrectly. Reaffirm the settings.
	Failed to change folder	Setting of each display may be incorrect. Reaffirm the settings.
	Host key collation error	
	Without access privileges	
	Image transmission failed	
	Transfer error	
	Error in Passive mode	
	Logout failure	
Internal error	Other errors	There is a problem with the FTP/SFTP function. Check the FTP/SFTP settings again.

---

# Troubleshooting

Check the symptoms on this table before asking for repair

Contact the dealer from whom you purchased the camera if you cannot resolve the problems or if you have symptoms other than those listed in this table.

## Cannot access camera from web browser

Causes and countermeasures	Reference
Are network cables Cat 5e or higher used for the network connection?	Quick Installation
<p>Check that the link lamp (LINK) is illuminated. If it is not illuminated, the connection to the LAN is not normal or the network to which the connection is made is not operating normally.</p> <p>Check the cable for faulty contact and wiring.</p>	Quick Installation
Check that the power to the machine is ON and that the power to the machine is ON.	Quick Installation
Are valid IP addresses set for your camera?	<a href="#">Configuring the network, p. 309</a>
<p>Are incorrect IP addresses accessed? Confirm the connection using the following method. In the Windows command prompt &gt; If Reply is returned from your camera under ping <b>IP address set for your camera</b>, it is operating normally. If Reply is not returned, check the connection using the PC connected to the same network as the camera as shown below. If the firewall setting of the PC is enabled, temporarily cancel the firewall setting before setting the camera.</p> <p>In an environment without a DHCP server, restart the camera with the Initialization button and set the IP address to <b>192.168.0.10(*)</b>. Then access the camera to reset the IP address (which initializes all settings).</p> <p>The IP address of the (*) Multisensor/PTZ integrated camera is 192.168.0.10 for the PTZ camera and 192.168.0.11 for the Multisensor camera.</p>	--
Make sure you are not using one of the reserved camera ports for other purposes.	<a href="#">Configuring</a>

Reserved ports are 20, 21, 22, 23, 25, 42, 53, 67, 68, 68, 69, 80, 110, 123, 161, 162, 443, 554, 995, 1883, 883, 10669, 10670, 59000–61000.	<a href="#">the network, p. 309</a>
Is the set IP address overlapping with other devices?	<a href="#">Configuring the network, p. 309</a>
Is the set address and the destination network subnet conflicting? (If the camera and the PC are connected in the same subnet)?	
Is the set IP address of the camera and PC set to the same subnet? Also, if <b>Use Proxy Server</b> is not set on the PC, or if you are accessing the camera within the same subnet, it is recommended that the <b>Remove from proxy</b> address be set. If the camera is connected to a different subnet, is the default gateway set for the camera correctly?	
Are you accessing the camera with a DDNS name that is different from the one registered with a DDNS service? Access the camera with the registered name.	--
When using HTTPS, access the camera using <code>https://&lt;IP address&gt;: port/</code> .	--

---

## Cannot access camera from Internet

Causes and countermeasures	Reference
Are the network settings for the camera correct? Configure the default gateway or DNS server address correctly. When using the DDNS service, make sure that it is set correctly. In networking, did you properly configure <b>Default gateway</b> ?	<a href="#">Configuring the network, p. 309</a>
Does the router have a port forwarding configuration? If your router does not have UPnP capability, you must configure the port forwarding configuration to allow access to the camera from the Internet. Refer to your router's Instruction Manual for how to configure. Is the UPnP function disabled on the router? Refer to the router's instruction manual and enable the UPnP function. Does the router have packet filtering or other settings that prohibit access from the Internet?	<a href="#">Configuring UPnP, p. 329</a>

---

Enable your router to access from the Internet. Refer to your router's instruction manual for how to configure this function.

Do you have access to the IP address (local address) for use on the local network? Check the IPv4 network settings, IPv6 network settings, and DDNS settings, and access the global address (or URL registered with the DDNS service) as the IP address of the camera for use on the Internet with the camera's port number.

[Configuring the network, p. 309](#)

Camera requests authentication when switching pages

If the user name or password has been changed while the camera is being accessed and the user name or password being logged in has been changed in another web browser, the authentication screen is displayed each time the screen is switched. Close the Web browser and access the camera again. If you have changed the **Authentication method** setting, close the web browser and access the camera again.

--

## High latency when displaying images

### Causes and countermeasures

### Reference

Are you accessing in HTTPS mode? In HTTPS mode, the display will be slower depending on the specifications of your PC for decoding processing.

--

Do you have access to your camera on the same local network via a proxy? Configure the PC so that it does not go through a proxy.

--

Are multiple users referring to the camera image at the same time? If multiple users refer to the camera image at the same time, the screen display may take longer or the camera image updating speed may be slower.

--

## Camera cannot be accessed from mobile or tablet terminal

Causes and countermeasures	Reference
URL is wrong. Or, is <b>/cam</b> not entered at the end of the URL? When accessing the camera from a portable terminal, enter <b>/cam</b> at the end of the URL to be used when accessing the camera from the PC.	--
Is the SSL encryption method of the HTTPS of the mobile terminal or tablet terminal different from that of this device? Set the <b>Connection</b> of the HTTPS of this device to <b>HTTP</b> and access the camera again.	--
When using HTTPS, access <code>https://IP address: port/</code> .	--

---

## No image

Causes and countermeasures	Reference
Please refer to the instruction manual for your mobile terminal/tablet terminal for information about the limitation of image data size that can be displayed on the mobile terminal/tablet terminal.	--

---

## Blurred image

Causes and countermeasures	Reference
Check that the focus is adjusted correctly. <a href="#">Adjusting the zoom/focus, p. 205</a>	

---

## Image not focused after booting

Causes and countermeasures	Reference
Focus and zoom are adjusted after starting the camera, and the camera can be out of focus for a certain period of time.	--

---

## Image is not updated

Causes and countermeasures	Reference
Depending on the web browser or version, images may not be updated or other problems may occur.	--
Images may stop being displayed due to network congestion or concentration of access to the machine. Request the acquisition of images by pressing <b>F5</b> on the keyboard.	--

## Images are dark

Causes and countermeasures	Reference
Is the <b>Brightness</b> set to darken? Click <b>Normal</b> for brightness.	<a href="#">About live image pages, p. 44</a>

## Images are too bright

Causes and countermeasures	Reference
Is the <b>Brightness</b> set to brighten? Click <b>Normal</b> brightness. When the <b>Adaptive black stretch</b> slider bar is moved in the - direction, the image is darkened.	<a href="#">About live image pages, p. 44</a> <a href="#">Configuring image quality, p. 187</a>

## Images are flickering

Causes and countermeasures	Reference
If flickering is a concern, set <b>Light control mode</b> to <b>Indoor scene</b> .	<a href="#">Configuring image quality, p. 187</a>

## Images not saved on SD card or read/write errors

Causes and countermeasures	Reference
Check that the SD card is mounted correctly and correctly.	--
Is the SD card formatted?	--
<b>MB</b> is displayed on the <b>Remaining capacity</b> of the <b>SD card</b> tab. Please format the SD card.	<a href="#">SD card options, p. 154</a>
<b>Remaining capacity</b> of the <b>SD card</b> tabs is not displayed? Check the password lock setting.	<a href="#">SD card options, p. 154</a>
If the mail notification or unique alarm <b>Diag.</b> function is used, has the recognition error of the SD card been received?	<a href="#">SD card options, p. 154</a>
In the <b>Maintenance &gt; Status &gt; SD card</b> logs <SD > Is the recognition error displayed? Format the SD card.	<a href="#">Configuring alarm notifications, p. 287</a> <a href="#">Configuring SMTP (E-mail), p. 315</a>
Is the SD card faulty? The SD card has a limited number of rewrites. Replace the SD card with a new one if it is rewritten frequently because it may last a long time.	--

## Cannot use voice transmission

Causes and countermeasures	Reference
Check that the microphone and speakers are connected correctly.	--
Transmission voice can only be used when connected with HTTPS.	

---

## No audio from network disk recorders or PC software

Causes and countermeasures	Reference
Some of network disk recorders and PC software do not support <b>G.711</b> . Set the speech compression method to <b>G.726 (32 kbps)</b> or <b>AAC-LC</b> .	<a href="#">Audio settings, p. 102</a>

---



## Live image not displayed

### Causes and countermeasures

### Reference

Press the **F5** key on the PC keyboard or press the **Live** button. [Viewing images from a PC, p. 40](#)

## Camera icon not displayed in Windows *Network*

### Causes and countermeasures

### Reference

Does the Windows operating system support UPnP? Add UPnP to your Windows operating system.

[Configuring UPnP, p. 329](#)

## Image not updated or displayed

### Causes and countermeasures

### Reference

The port of this equipment may have been filtered by the firewall function of the virus -- check software. Change the HTTP port number of your camera to a port number that is not filtered.

## H.265/H.264 stream is choppy

### Causes and countermeasures

### Reference

Make sure the computer fulfills the minimum hardware requirements.

[Minimum hardware requirements for computers, p. 421](#)

## Back button of Web browser does not show correct screen

### Causes and countermeasures

### Reference

Press **F5** on the keyboard to update the screen. --

## "Access is concentrated. Run later." message on live page

Causes and countermeasures	Reference
Change the <b>Bit Rate* per Client</b> setting of the stream to a lower value.	<a href="#">Configuring streaming options, p. 177</a>
Change the <b>Initial display stream</b> setting to the lower <b>Max bit rate (per client) *</b> streams.	<a href="#">Configuring JPEG image options, p. 174</a>

---

## Browser messages incomplete/broken

Causes and countermeasures	Reference
Change the display settings of the PC. Right-click the PC screen and change the display -- by clicking <b>Display Settings &gt; Change the size of text, apps, and other items.</b>	

---

# SD card folder structure

## Folder structure of the PTZ camera

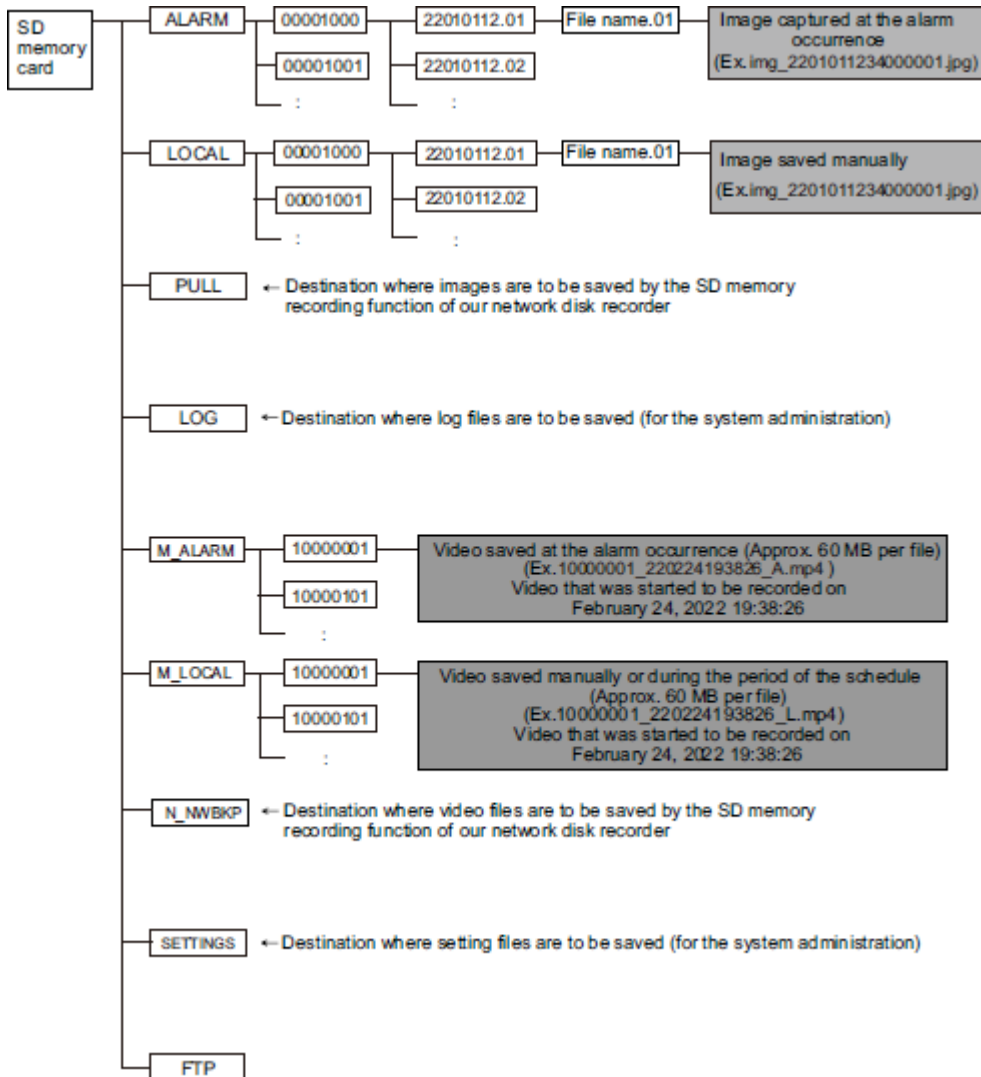

## Folder structure of the Multisensor Camera

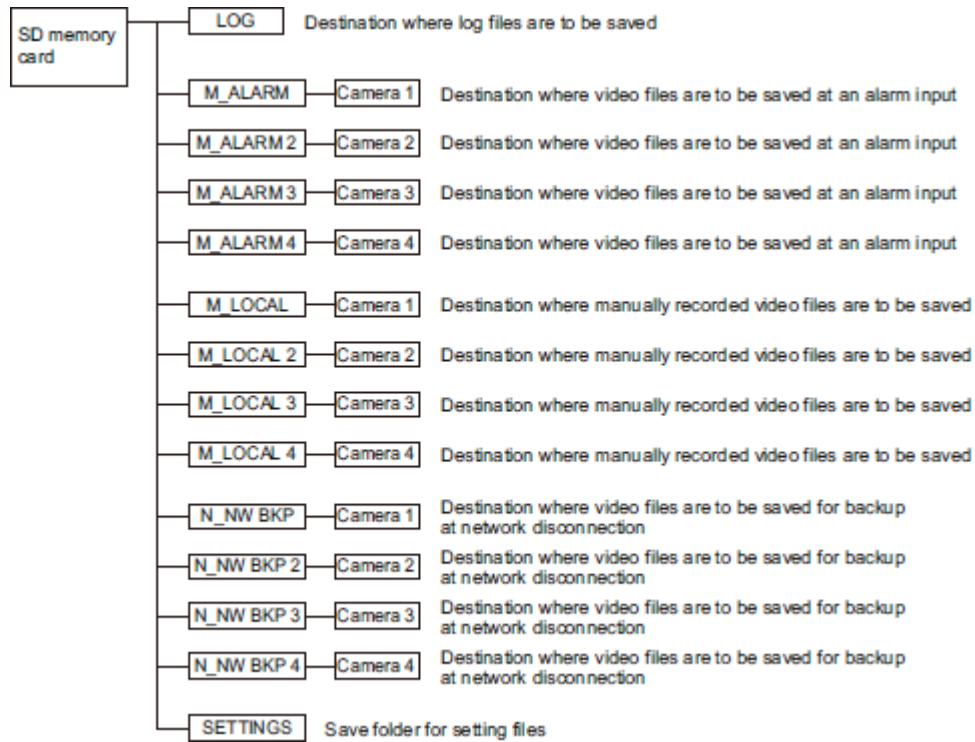

# Minimum hardware requirements for computers

CPU	<ul style="list-style-type: none"><li>▪ Min. Intel® Core™ i5-6500</li><li>▪ Intel® Core™ i7-6700 or better recommended</li></ul>
Memory	Min. 4 GB (2 GB x 2, dual channel)
Network	10BASE-T/100BASE-TX/1000BASE-T, 1 port
Sound	Sound card (for voice function)
Display	<ul style="list-style-type: none"><li>▪ Min. 1024 x 768 pixels</li><li>▪ 3840 x 2160 pixels or better recommended</li><li>▪ 24 bits color depth or better</li></ul>
Operating system	Microsoft Windows 10/11
Web browser	Google Chrome™ Firefox Microsoft Edge (after Chromium)
Other	Adobe® Reader (for viewing PDF files)

---

# MOBOTIX

BeyondHumanVision

[EN\\_01/25](#)

MOBOTIX AG • Kaiserstrasse • D-67722 Langmeil • Tel.: +49 6302 9816-103 • [sales@mobotix.com](mailto:sales@mobotix.com) • [www.mobotix.com](http://www.mobotix.com)

MOBOTIX is a trademark of MOBOTIX AG registered in the European Union, the U.S.A., and in other countries. Subject to change without notice. MOBOTIX do not assume any liability for technical or editorial errors or omissions contained herein. All rights reserved. © MOBOTIX AG 2021