

BE THE ONE

Quick Installation

MOBOTIX ONE M1A-S (FIX & VARIO)

© 2024 MOBOTIX AG



Table of Contents

Table of Contents	2
Before You Start	5
Support	6
MOBOTIX Support	6
MOBOTIX eCampus	6
MOBOTIX Community	6
Safety Notes	7
Legal Notes	7
Notes on System Security	9
Drilling Template	11
Drilling Template PDF	12
Scope of Delivery	13
ONE M1A-S (FIX & VARIO): Scope of Delivery	14
Mounting Supplies: Scope of Delivery	15
Overview	17
Technical Specifications	19
Order Information	20
Hardware	20
Image and Video Properties	22
General Software Features	23
Video Analysis	24
Video Management Software	24
Supported Lenses and Sensor	25
Dimensions	26
Mounting	27
Before Mounting the Camera	28
Protective Measures	29
Opening the Camera Housing	30
Removing the Cable Duct Cover	30
Closing the Camera Housing	31
Connecting the Camera	31
Connecting a USB-C Device	32
Connecting I/O Devices	34
Connecting the Camera to the Network	36

Mounting Options	37
Tiltability	37
Mounting to a Wall	38
Mounting to a Pole	41
Mounting to a Ceiling	45
Adjust the Camera	48
Adjust the Camera Orientation	49
Adjust the Lens Focus (M1A-S Fix only)	49
Operating the Camera	51
Getting Started	52
LED states	52
Boot Options of the Camera	53
Network Settings	56
Manual Setup	56
Automatic Setup using MxManagementCenter	58
Network Settings on the Camera in the Web Browser	59
Camera Software in the Browser	61
Access the Camera in the Web Browser	62
Basic Settings	62
Maintenance	65
Replacing the microSD Card	66
Cleaning the Camera and Lenses	67

Before You Start

This section contains the following information:

Support	6
Safety Notes	7
Legal Notes	7

Support

MOBOTIX Support

If you need technical support, please contact your MOBOTIX dealer. If your dealer cannot help you, he will contact the support channel to get an answer for you as quickly as possible.

If you have internet access, you can open the MOBOTIX help desk to find additional information and software updates.

Please visit www.mobotix.com > [Support](#) > [Help Desk](#).



MOBOTIX eCampus

The MOBOTIX eCampus is a complete e-learning platform. It lets you decide when and where you want to view and process your training seminar content. Simply open the site in your browser and select the desired training seminar.

Please visit www.mobotix.com/ecampus-mobotix.



MOBOTIX Community

The MOBOTIX community is another valuable source of information. MOBOTIX staff and other users are sharing their information, and so can you.

Please visit community.mobotix.com.



Safety Notes

- This camera must be installed by qualified personnel and the installation should conform to all local codes.
- This product must not be used in locations exposed to the dangers of explosion.
- Do not use this product in a dusty environment.
- Protect this product from moisture or water entering the housing.
- Install this product as outlined in this document. A faulty installation can damage the product!
- Do not replace batteries of the camera. If a battery is replaced by an incorrect type, the battery can explode.
- This equipment is not suitable for use in locations where children are likely to be present.
- External power supplies must comply with the Limited Power Source (LPS) requirements and share the same power specifications with the camera.
- When using a power adapter, the power cord shall be connected to a socket-outlet with proper ground connection.
- To comply with the requirements of EN 50130-4 regarding the power supply of alarm systems for 24/7 operation, it is highly recommended to use an uninterruptible power supply (UPS) for backing up the power supply of this product.

Legal Notes

Legal Aspects of Video and Sound Recording

You must comply with all data protection regulations for video and sound monitoring when using MOBOTIX AG products. Depending on national laws and the installation location of the cameras, the recording of video and sound data may be subject to special documentation or it may be prohibited. All users of MOBOTIX products are therefore required to familiarize themselves with all applicable regulations and to comply with these laws. MOBOTIX AG is not liable for any illegal use of its products.

Declaration of Conformity

The products of MOBOTIX AG are certified according to the applicable regulations of the EC and other countries. You can find the declarations of conformity for the products of MOBOTIX AG on www.mobotix.com under **Support > Download Center > Marketing & Documentation > Certificates & Declarations of Conformity**.

RoHS Declaration

The products of MOBOTIX AG are in full compliance with European Unions Restrictions of the Use of Certain Hazardous Substances in Electrical and Electronic Equipment (RoHS Directive 2011/65/EC) as far as they are subject to these regulations (for the RoHS Declaration of MOBOTIX, please see www.mobotix.com, **Support > Download Center > Marketing & Documentation > Brochures & Guides > Certificates**).

Disposal

Electrical and electronic products contain many valuable materials. For this reason, we recommend that you dispose of MOBOTIX products at the end of their service life in accordance with all legal requirements and regulations (or deposit these products at a municipal collection center). MOBOTIX products must not be disposed of in household waste! If the product contains a battery, please dispose of the battery separately (the corresponding product manuals contain specific directions if the product contains a battery).

Disclaimer

MOBOTIX AG does not assume any responsibility for damages, which are the result of improper use or failure to comply to the manuals or the applicable rules and regulations. Our General Terms and Conditions apply. You can download the current version of the **General Terms and Conditions** from our website at www.mobotix.com by clicking on the corresponding link at the bottom of every page.

It is the User's responsibility to comply with all applicable local, state, national and foreign laws, rules, treaties and regulations in connection with the use of the Software and Product, including those related to data privacy, the Health Insurance Portability and Accountability Act of 1996 (HIPPA), international communications and the transmission of technical or personal data.

FCC Disclaimer

This equipment has been tested and found to comply with the limits for a Class A digital device, pursuant to part 15 of the FCC Rules. These limits are designed to provide reasonable protection against harmful interference when the equipment is operated in a commercial environment. This equipment generates, uses, and can radiate radio frequency energy and, if not installed and used in accordance with the instruction manual, may cause harmful interference to radio communications. Operation of this equipment in a residential area is likely to cause harmful interference in which case the user will be required to correct the interference at his own expense.

Notes on System Security

To protect the camera against security risks in data technology, the following measures are recommended after the installation has been completed:

MxManagementCenter:

- Menu **View > Wizards & Tools > Secure System:**
 - **Change camera factory default password:** ✓
 - **Enable encrypted HTTPS:** ✓
 - **Disable public access:** ✓
 - **User Management** (for all users):
 - **Force Complex Password:** ✓
 - **Log out on Inactivity:** After 5 min

User interface of the camera in the browser:

- **Admin Menu > Network Setup > Web Server:**
 - **Enable intrusion detection:** ✓
 - **Notification threshold:** 10
 - **Timeout:** 60 minutes
 - **Block IP Address:** ✓

For more information on this new feature, please read the «Cyber Protection Guide» on www.mobotix.com (under Support > Download Center > Documentation > Brochures & Guides > Cyber Security).

Drilling Template

Open this file in a PDF viewer (Acrobat Reader, Foxit Reader, or similar) and print the file **without scaling (original size)**.

NOTE! Download the drilling template from the MOBOTIX website: www.mobotix.com > [Support](#) > [Download Center](#) > [Marketing & Documentation](#) > [Drilling Templates](#).

CAUTION! Always print or copy the drilling template at 100% of the original size!

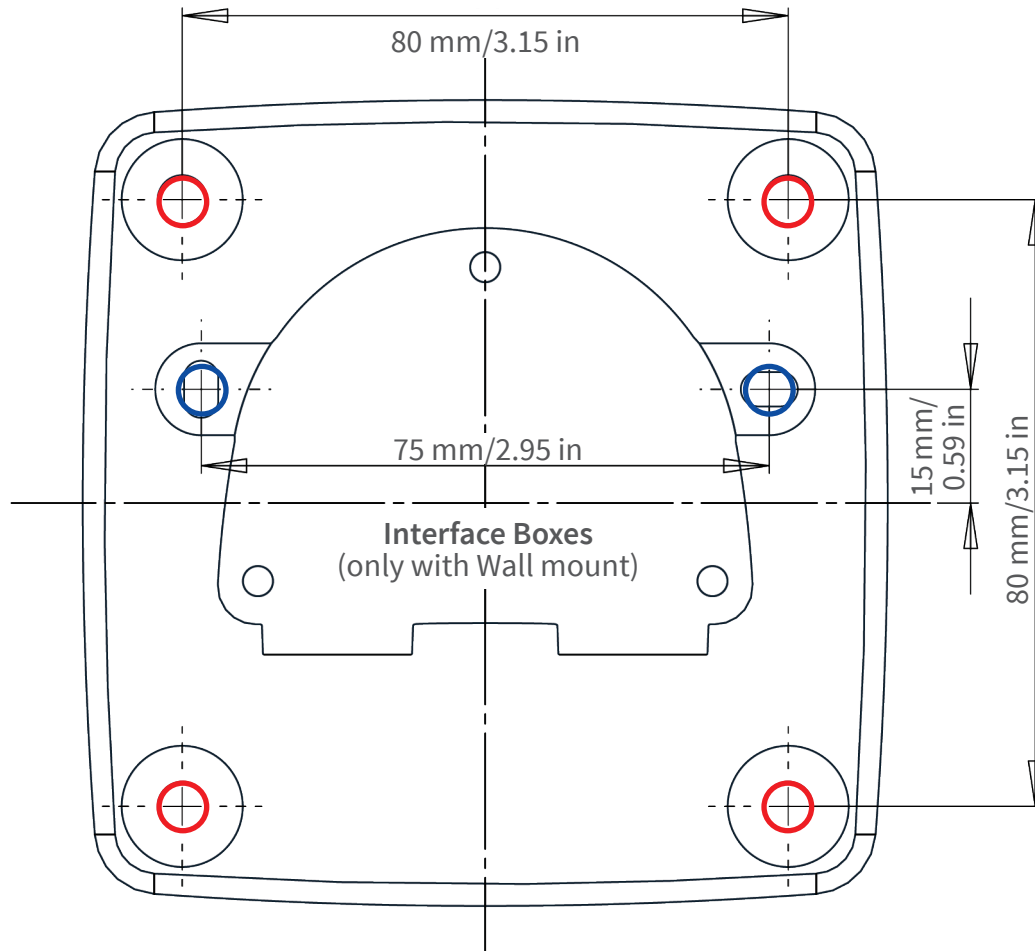

- Bohrungen für Befestigungsschrauben \varnothing 5 mm
- Holes for mounting screws 5 mm diameter
- Trous pour les vis de montage de 5 mm diamètre



- Bohrungen für Interface Boxen (nur bei Wandmontage)
- Holes for Interface Boxes (only with Wall mount)
- Trous pour les boîtes d'interface (uniquement pour le montage mural)

Installation nur auf ebener Fläche! Unebenheiten dürfen 0,5 mm nicht überschreiten!

Installation only on level surface! Unevenness must not exceed 0.5 mm/0.02 in!

Montage uniquement sur une surface plane ! Les inégalités ne doivent pas dépasser 0,5 mm !



Nur in Originalgröße kopieren oder ausdrucken!

Always copy or print at 100% of original size!

Copier ou imprimer uniquement aux dimensions d'origine !

Scope of Delivery

This section contains the following information:

ONE M1A-S (FIX & VARIO): Scope of Delivery	14
Mounting Supplies: Scope of Delivery	15

ONE M1A-S (FIX & VARIO): Scope of Delivery



Scope of delivery ONE M1A-S (FIX & VARIO) Body

Item	Count	Description
1.1	1	ONE M1A-S (FIX & VARIO) with sensor module on Vario Flex Mount
1.2	1	MOBOTIX Ethernet patch cable, 50 cm/19.7 in (installed)
1.3	1	SD card 64 GB (installed)
1.4	1	Mounting supplies (see Scope of Delivery ONE M1A-S (FIX & VARIO) Mounting Supplies , p. 15)

Scope of delivery ONE M1A-S (FIX & VARIO) Body

Item	Count	Description
1.5	1	Important Safety Information
1.6	1	Sticker with IP address of camera

Mounting Supplies: Scope of Delivery



Scope of Delivery ONE M1A-S (FIX & VARIO) Mounting Supplies

Item	Count	Description
M.1	1	Module wrench (yellow) *M1A-S FIX only
M.2	1	Sealing ring for VarioFlex and ceiling mount
M.3	5	Screw caps plastic white

Scope of Delivery

Mounting Supplies: Scope of Delivery

Scope of Delivery ONE M1A-S (FIX & VARIO) Mounting Supplies

Item	Count	Description
M.4	1	5mm Allen wrench
M.5	4	Stainless steel washers Ø5.3 mm
M.6	4	Wood screw 4.5x60 mm
M.7	4	Dowel S8
M.8	1	Tweezers for replacing the SD card

Overview

The MOBOTIX ONE M1A-S (FIX & VARIO) consists of the camera with VarioFlex mount.



① VarioFlex Mout

③ Housing

⑤ Ambient light sensor

⑦ IR LED light

⑨ Speaker

② Microphone

④ Status LED

⑥ Lens with cover

⑧ IR LED light

Technical Specifications

This section contains the following information:

Order Information	20
Hardware	20
Image and Video Properties	22
General Software Features	23
Video Analysis	24
Video Management Software	24
Supported Lenses and Sensor	25
Dimensions	26

Order Information

Name	MOBOTIX ONE M1A-S (FIX & VARIO)
Order Code:	Mx-ONE-M1A-S-8XXXXX

Hardware

Feature	Properties
Image sensor (color or B&W sensor)	up to 4K UHD 3840x2160, 16:9, 1/1,8"
Available Lenses	Varifocal Wide (4.3-9.3mm F/1.3/112-47°), Varifocal Tele (11-29mm F/1.7/42-15°), Fixed lens (see Supported Lenses and Sensor, p. 25)
Optical zoom	Yes (for varifocal models)
Light sensitivity	<ul style="list-style-type: none"> ▪ Color sensor (day): 0,1 lx @ 1/60s; 0,005 lx @ 1s ▪ BW sensor (night): 0,02 lx @ 1/60s; 0,001 lx @ 1s
Exposure control	Manual and automatic mode 1 s to 1/16,000 s
IK protection class	IK10 (housing except lens)
IP / NEMA protection class	IP66 / NEMA 4X
Intended use	Not use in hazardous areas (Ex area)
Operating temperature range	-40 to 65 °C/-40 to 149 °F
Min. cold start temperature	-25 °C/-22 °F
Relative Humidity	95 % non-condensing
Internal DVR Storage	Internal microSD card (SDHC/SDXC), 64 GB out of the box, max. 1 TB.

Feature	Properties
I/Os	<p>INPUT</p> <ul style="list-style-type: none"> ▪ Contact Closure (no galvanic isolation necessary) or up to 50V AC/DC ▪ max. length for cables: 50m <p>OUTPUT</p> <ul style="list-style-type: none"> ▪ 2x Dry contact, form A (AC/DC, up to 50V / 60 W/ 2A)
Microphone/Speaker	<ul style="list-style-type: none"> ▪ Embedded ▪ Microphone Sensitivity: -35 +/-4 dB (0 dB = 1 V/pa, 1 kHz) ▪ 1 Embedded Speaker: 0.9 W at 8 Ohm ▪ 1 External Speaker optional
Integrated illumination	2 x embedded IR LEDs, 850nm, up to 30 m/100 ft (may be more depending on scene)
Shock detector (tamper detection)	Yes
Max. power consumption	max. 12,95 W (average may be significantly lower)
Electrical surge protection	Overvoltage Protection Box (not part of the scope of delivery)
PoE standard	PoE (802.3af-2003)/Class 3
Interfaces	<ul style="list-style-type: none"> ▪ Ethernet 1000BaseT (RJ45 according to EIA/TIA-568B) ▪ USB 2.0 via USB-C connector ▪ 12-24VDC power supply ▪ Input / Output ▪ Ext. Speaker
Mounting Options	<p>Wall-mountable (default)</p> <p>Ceiling- or pole-mountable (with accessory, compatible with M26)</p>
Dimensions (height x width x depth)	222 x 131 x 238 mm
Weight	Approx. 0,973 kg/2,15 lbs
Housing	PBT-30GF
Standard accessories	See ONE M1A-S (FIX & VARIO): Scope of Delivery, p. 14

Technical Specifications

Image and Video Properties

Feature	Properties
Tiltability of camera	<ul style="list-style-type: none">Wall & pole mounted Horizontal: 180° Vertical: 110°Ceiling mounted Horizontal: 360° Vertical: 110°
Detailed technical documentation	www.mobotix.com > Support > Download Center > Marketing & Documentation
MTBF	100,000 hours
Certificates	EN 55032, EN 55035, EN 61000-6-1, EN 61000-6-2, EN 61000-6-3, EN 61000-6-4, EN 62368-1, EN 63000, AS/NZS CISPR32, 47 CFR Part 15b
Protocols	DHCP (client and server), DNS, ICMP, IGMP v3, IPv4, IPv6, HTTP, HTTPS, FTP, FTPS, NFS, NTP (client and server), MQTT, RTP, RTCP, RTSP, SFTP, SIP (client and server), SMB/CIFS, SNMP, SMTP, SSL/TLS 1.3, TCP, UDP, VLAN, VPN, Zeroconf/mDNS
Manufacturer warranty	5 years

Image and Video Properties

Feature	Properties
Available video codecs	<ul style="list-style-type: none">H.264, H.265MxPEG+MJPEG
Image resolutions	VGA 640x360, XGA 1024x576, HD 1280x720, FullHD 1920x1080, QHD 2560x1440, 4K UHD 3840x2160
Max. image resolution	4K UHD 3840x2160 (8MP)
Multi streaming	H.264, H.265
Multicast stream via RTSP	Yes
Max. frame rate	MxPEG: 20@4K, H.264: 30@4K, H.265: 30@4K

General Software Features

Feature	Properties
Software features	<ul style="list-style-type: none"> ▪ H.264, H.265 Multistreaming ▪ Multicast stream via RTSP ▪ Digital pan, tilt, zoom/vPTZ (up to 8x zoom) ▪ Genetec protocol integration ▪ Programmable exposure zones ▪ Snapshot recording (pre/post-alarm images) ▪ Continuous recording ▪ Event recording ▪ Time-controlled flexible event logic ▪ Weekly schedules for recordings and actions ▪ Event video and image transfer via FTP and email ▪ Playback and QuadView via web browser ▪ Animated logos on the image ▪ Master/Slave functionality ▪ Privacy zone scheduling ▪ Remote alarm notification (network message) ▪ Programming interface (HTTP-API) ▪ MxMessageSystem
ONVIF compatibility	Profile G, S, T, (M with later firmware release)
Master/Slave functionality	Yes
Remote alarm notification	email, network message (HTTP/HTTPS), SNMP, MxMessageSystem, MQTT
DVR/image storage management	<ul style="list-style-type: none"> ▪ On internal microSD card ▪ On external USB and NAS devices ▪ Different streams for live image and recording ▪ MxPEG+ only ▪ MxFFS with buffered archive, pre- and post-alarm images, storage monitoring with error reporting

Technical Specifications

Video Analysis

Feature	Properties
Camera and data security	User and group management, SSL connections, IP-based access control, IEEE 802.1X, intrusion detection, digital image signature
Digitally signed firmware	Yes (to prevent firmware file tampering)

Video Analysis

Feature	Properties
Video motion detection	Yes
MxActivitySensor	Version 1.0, 2.1, 3.0 (incl. AI Motion and Loitering Detection)
MOBOTIX App support	Yes with a later FW release

Video Management Software

Feature	Properties
MOBOTIX HUB	Yes www.mobotix.com > Support > Download Center > Software Downloads
MxManagementCenter	Yes (latest version recommended) www.mobotix.com > Support > Download Center > Software Downloads
MOBOTIX Cloud	Streaming & Events supported
MOBOTIX LIVE App	Yes (available in Google Play Store (Android) and Apple App Store (iOS)).
3rd Party VMS Software	see ONVIF Profile S, T and G specification

Supported Lenses and Sensor

Lens	Sensor
Fixed lens (120°, 95°, 60°, 45°, 30°, 15°)	4K Sensor as D/N IR cut / Night Version
Varifocal Tele Lens 42°-15°	4K Sensor as D/N IR cut / Night Version
Varifocal Wide Lens 112°-47°	4K Sensor as D/N IR cut / Night Version

Dimensions

NOTE! Download the drilling template from the MOBOTIX website: www.mobotix.com > **Support** > **Download Center** > **Marketing & Documentation** > **Drilling Templates**.

CAUTION! Always print or copy the drilling template at 100% of the original size!

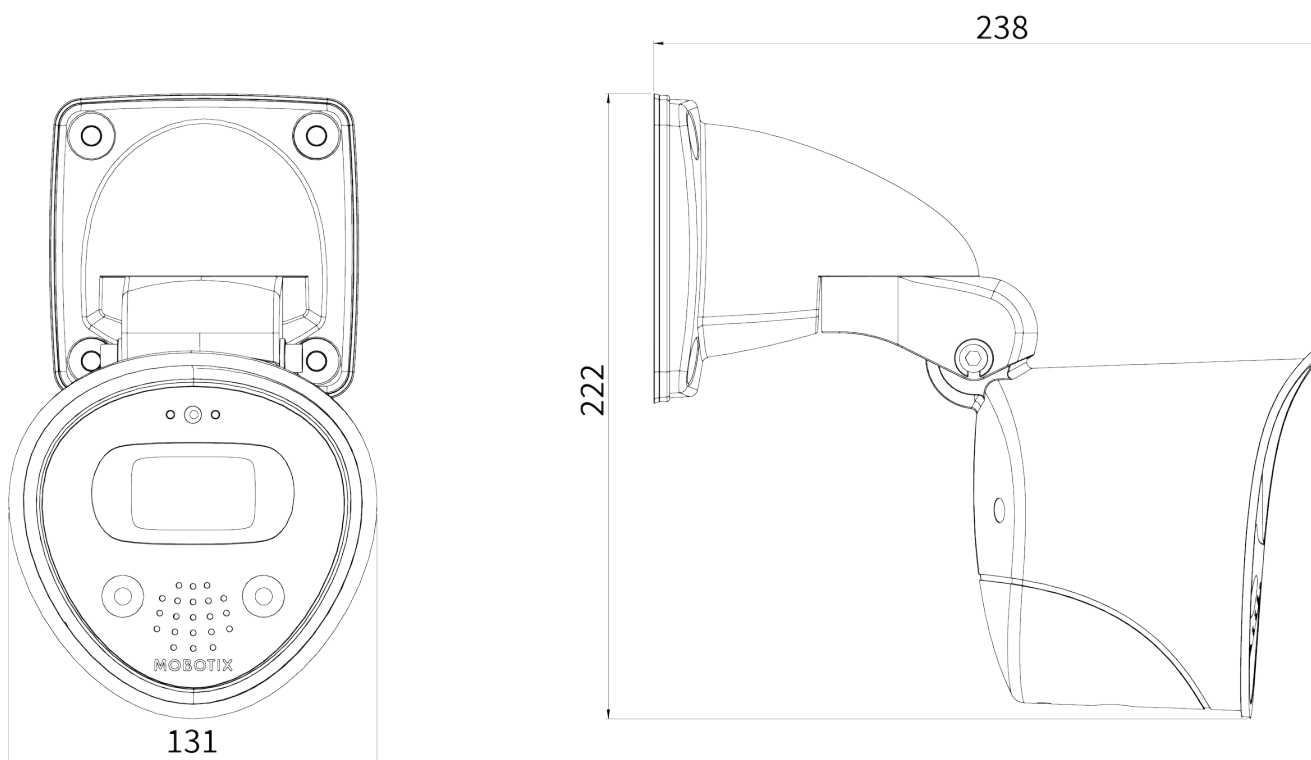

Fig. 1: MOBOTIX ONE M1A-S (FIX & VARIO): All measurements in mm

Mounting

This section contains the following information:

Before Mounting the Camera	28
Opening the Camera Housing	30
Closing the Camera Housing	31
Connecting the Camera	31
Mounting Options	37
Adjust the Camera	48

Before Mounting the Camera

CAUTION! You will need the camera's IP address to access the camera in the network (see [Camera Software in the Browser, p. 61](#)).

Before mounting the camera, make sure to copy the IP address ① inside the camera housing (see [Opening the Camera Housing, p. 30](#)) or on the camera packaging.



The MOBOTIX ONE M1A-S (FIX & VARIO) has been designed for various mounting options:

- Wall mounting (see [Mounting to a Wall, p. 38](#))
- Ceiling Mounting (see [Mounting to a Ceiling, p. 45](#))
- Pole mounting (see [Mounting to a Pole, p. 41](#))

NOTE! Download the drilling template from the MOBOTIX website: www.mobotix.com > [Support](#) > [Download Center](#) > [Marketing & Documentation](#) > [Drilling Templates](#).

CAUTION! Always print or copy the drilling template at 100% of the original size!

Before mounting the MOBOTIX ONE M1A-S (FIX & VARIO), the following questions should be answered:

- Where and how will the camera be mounted?
- How is the mounting surface level?
- Which other mounting options are available?
- Which accessories might be needed?
- How is the camera connected to the network and how is the power supplied?
- How are the connections furnished from the building?

- What cabling considerations are necessary?
- Do you want to use a larger SD card (see [Replacing the microSD Card, p. 66](#))?

The following sections will answer these questions. If you have further questions, please ask your MOBOTIX partner or contact the MOBOTIX support under www.mobotix.com > [Support](#) > [Help Desk](#).

Protective Measures

WARNING! When laying cables indoors and outdoors, the current regulations for cable laying, lightning and fire protection must always be observed.

MOBOTIX cameras and devices are protected against the effects of minor over voltages by a number of measures. However, these measures cannot prevent larger surge voltages from causing damage to the camera. When installing the cameras outdoors, special attention should therefore be paid to lightning protection and the associated dangers for the building and network infrastructure.

In general, you should only have MOBOTIX cameras and devices installed by certified specialist companies that are familiar with the installation and safe operation of network devices and the underlying regulations for lightning and fire protection as well as the current technology for preventing damage from surge voltages.

Notes on Cable Laying

- **Data cable:** Only double-shielded CAT5 cable or better (S/STP) may be used as data cable for the Ethernet interface.
- **Cable length:** The individual cable sections must not exceed the maximum permissible lengths in order to ensure perfect data transmission.
- **Avoidance of induction:** Data cables may only be laid parallel to power or high-voltage lines if the prescribed minimum distances are observed.
- Only use MOBOTIX cables and connectors to ensure IP66 weather resistance.

Fire Protection

When laying cables for the power supply, the relevant country-specific regulations (e.g. VDE in Germany) and the fire protection regulations valid at the installation site must be observed.

Lightning and Surge Protection

Measures should always be taken to protect this device from electrical surge damage.

Further information on how to avoid damage caused by lightning and over voltage is available from manufacturers of lightning and over voltage protection devices.

Opening the Camera Housing

The following tasks require opening the camera housing:

- [Replacing the microSD Card, p. 66.](#)
- [Connecting I/O Devices, p. 34.](#)
- [Connecting a USB-C Device, p. 32.](#)
- Replacing the RJ-45 network cable

1. Using the supplied 5 mm Allen wrench [M.4, p. 16](#), release the bolt at the bottom side of the housing cover. Leave the bolt and washer in the housing cover.



2. Lift the housing cover off the camera housing.



Removing the Cable Duct Cover

The following tasks require removing the cable duct cover:

- [Connecting I/O Devices, p. 34.](#)
- [Connecting a USB-C Device, p. 32.](#)
- Changing the RJ-45 network cable.

1. Using the supplied 5 mm Allen wrench [M.4, p. 16](#) to slightly loosen the screw in the joint of the wall and ceiling bracket and rotate the camera housing as far as possible towards the wall and ceiling mount

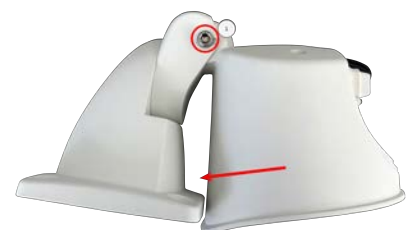

2. Slide out the cable duct cover with slight pressure.



Closing the Camera Housing

1. Using the supplied 5 mm Allen wrench [M.4, p. 16](#) to slightly loosen the screw in the joint of the wall and ceiling bracket and rotate the camera housing as far as possible towards the wall and ceiling mount.
2. If removed press the cover of the cable duct in along the guide with light pressure until the joint of the wall and ceiling mount is completely covered.
3. Attach the housing cover and use the 5 mm Allen wrench [M.4, p. 16](#), to close the bolt at the back of the housing cover.

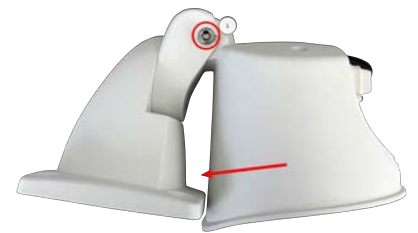

Connecting the Camera

All connections to the camera (network, USB-C, inputs/outputs) can be made directly on the camera. No further accessories are required for this. A PoE switch provides the camera's power supply.

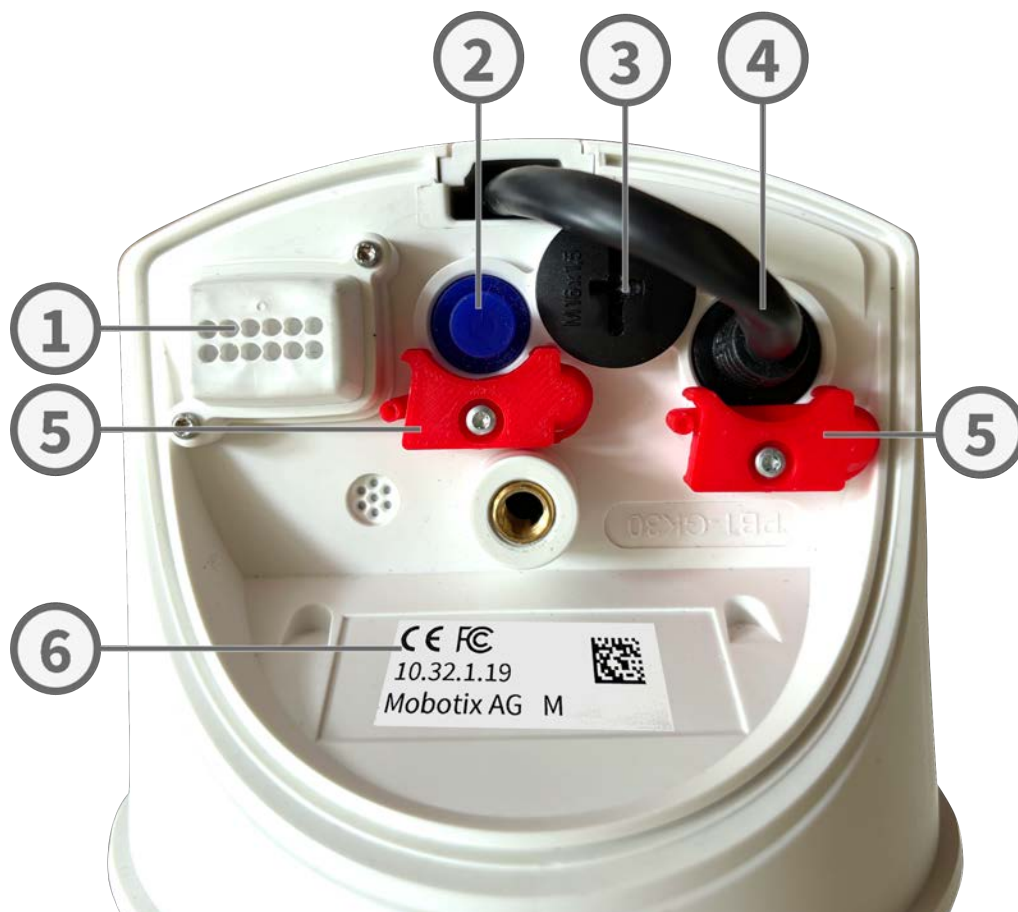

① IO sockets

② USB-C connector

③ Micro SD Slot and reset pin

④ RJ-45 Network connector

⑤ Plug Locks

⑥ IP-Adress label

Connecting a USB-C Device

The camera has a USB-C port that allows connecting external storage media or extension boxes, for example.

1. To uncover the USB-C port, open the safety spring ① of the plug lock by pushing it away from the sealing plug, then remove the sealing plug.



2. Plug the USB-C connector into the port and press in firmly until the safety spring of the plug lock clicks into place.



3. Connect the USB-C device to the USB cable.

NOTE!

Before closing the camera housing, guide all connection cables correctly through the cable duct and the wall or ceiling mount.

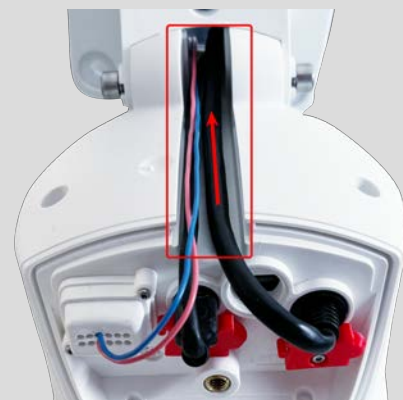

Connecting I/O Devices

The MOBOTIX ONE M1A-S (FIX & VARIO) has an I/O connection terminal that allows multiple I/O devices to be connected.

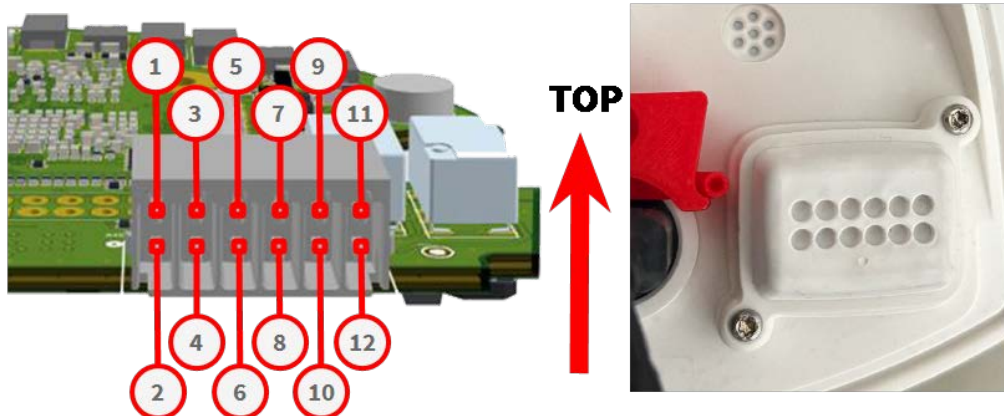

The slots are assigned as follows:

Assignment of the I/O Terminals

- | | |
|----------|----------|
| ① DC - | ② DC + |
| ③ N/A | ④ N/A |
| ⑤ Spk - | ⑥ Spk + |
| ⑦ Out1 - | ⑧ Out1 + |
| ⑨ Out2 - | ⑩ Out2 + |
| ⑪ In - | ⑫ In + |

CAUTION! Before you proceed pay attention to the intended use or polarity of the slots. Ensure that the connections are assigned correctly as shown in the overview diagram above.

- To uncover the I/O connectors, release the screws ① from the dome cap, then remove it.



2. Strip 5 mm of insulation from the ends of the connection wires of the I/O devices and push the wires through the openings in the dome cap corresponding to the appropriate I/O slots.

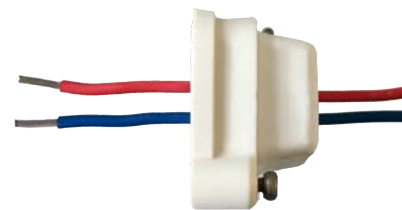

3. Plug the connection wires of the respective units into the corresponding slots ② (see , p. 34) of the connection terminal and check their tight fit.

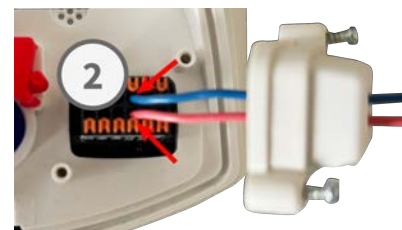

4. Attach the dome cap with the screws ③ provided.



NOTE!

Before closing the camera housing, guide all connection cables correctly through the cable duct and the wall or ceiling mount.

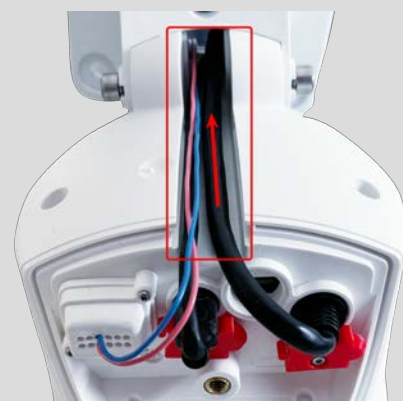

Connecting the Camera to the Network

CAUTION!

- The PoE switch must provide Class 4 according to PoE (802.3af-2003) as well as the 100/1000 Mbps Ethernet interface of the camera.
- It is highly recommended to use an uninterruptible power supply (UPS) for the switch.
- The maximum length of the network cable for remotely supplying power is 100 m (300 ft).



Connecting the camera to the network

1. Connect the supplied patch cable 1.6, p. 15 with the PoE network connection of the building.

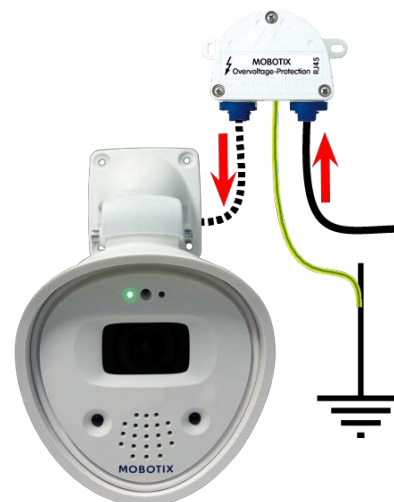

NOTE! It's recommended to connect the camera with the MX-Overvoltage-Protection-Box (RJ-45 or LSA). This ensures a weatherproof (IP66) network and power connection network connector with surge protection of up to 4 kV (refer to the corresponding manual. All manuals can be downloaded from the MOBOTIX website (www.mobotix.com > Support > Download Center > Marketing & Documentation).

Mounting Options

You can mount the MOBOTIX ONE M1A-S (FIX & VARIO) to any even surface on a wall, a ceiling or to poles with up to 180 mm/7.1" diameter using the stainless steel pole mount that is available as accessory. The concealed cabling improves security of the installation.

CAUTION! Installation only on flat surface! Unevenness must not exceed 0.5 mm/0.02 in!
Only use genuine MOBOTIX patch cables to guarantee the weatherproofness!

The Vario Flex Mount has been dimensioned to fully cover conventional flush-mounted sockets (without frame) or cavity sockets.

NOTE! Before mounting the camera, determine its ideal position and make sure that the field of view is not obstructed in any way. Once the camera has been mounted, you can fine-tune the image. If the monitored area changes or the camera has to be installed in a different location, you can simply exchange the sensor modules.

Tiltability

Tiltability when Mounted on a Wall or Pole

- horizontally: 180°
- vertically: 110°



Tiltability when Mounted on a Ceiling

- horizontally: 360°
- vertically: 110°



Mounting to a Wall

Before mounting the camera, make sure that a network connection with power supply according to the PoE (802.3af-2003) standard is available at the mounting position (see [Connecting the Camera to the Network](#), p. 36).

NOTE! Download the drilling template from the MOBOTIX website: www.mobotix.com > [Support](#) > [Download Center](#) > [Marketing & Documentation](#) > [Drilling Templates](#).

CAUTION! Always print or copy the drilling template at 100% of the original size!

NOTE! Do not use the dowels if the installation surface is wood. Only use the screws to fasten the mounting plate directly on the surface. In order to facilitate screwing in wood, the positions should first be pre-drilled using a 2 mm drill bit, for example (drilling depth just slightly less than screw length).

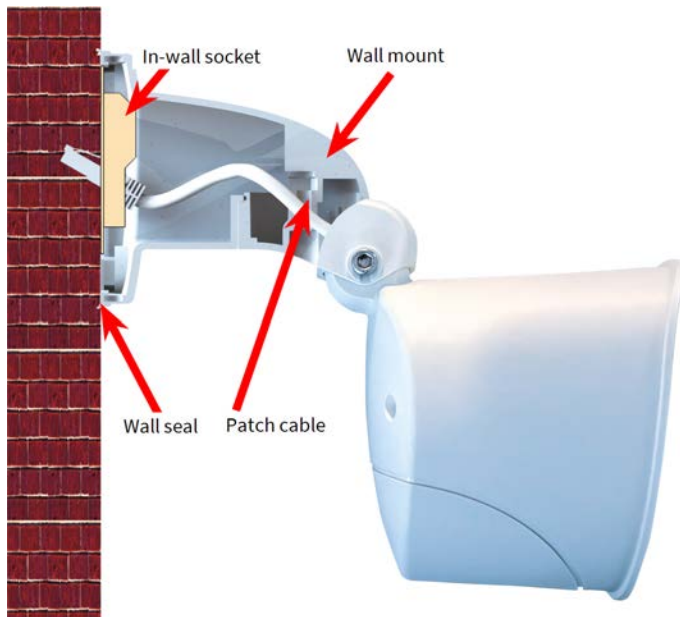

When installing on-wall cabling, breaking out one of the four possible openings in the base of the wall mount with a pliers will ensure that the cables can be fed neatly into the camera. The connection to the camera patch cable can be established using a suitable adapter within the wall mount.



CAUTION! If using the camera outdoors, only use the opening at the bottom of the mount to prevent water from entering the mount!

Procedure

1. Mark the holes for drilling using the drilling template (see [Drilling Template, p. 11](#)).

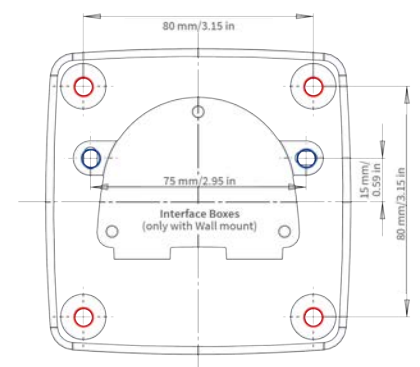

Mounting

Mounting Options

2. Drill the holes for the supplied screw anchors.

NOTE! Screw anchors do not have to be fitted if the surface is made of wood.

3. Fully push the dowels [M.7](#) into the holes you drilled.
4. Attach wall seal: Place the white rubber sealing ring with the groove on the edge of the wall mount.



5. Connect the on-site network cable to the camera patch cable using an adapter or insert the patch cable into the RJ45 outlet (also see [Connecting the Camera to the Network](#), p. 36).

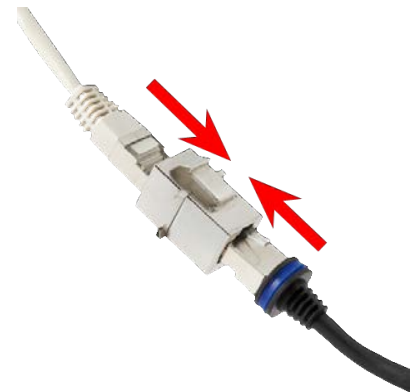

NOTE! When using a MOBOTIX Overvoltage Protection Box refer to the corresponding manual. All manuals can be downloaded from the MOBOTIX website (www.mobotix.com > [Support](#) > [Download Center](#) > [Marketing & Documentation](#)).

6. Mount the camera using the four screws each with a washer [M.7](#).



CAUTION! Do not overtighten the screws as this may damage the plastic mount.

7. Place the white plastic caps [M.3](#) on the screw heads.



Mounting to a Pole

Before mounting the camera, make sure that a network connection with power supply according to the PoE (802.3af-2003) standard is available at the mounting position (see [Connecting the Camera to the Network](#), p. 36).

CAUTION! The mounting pole should have a diameter between 60 and 180 mm.

Dimensions of the MOBOTIX ONE M1A-S (FIX & VARIO) pole mount

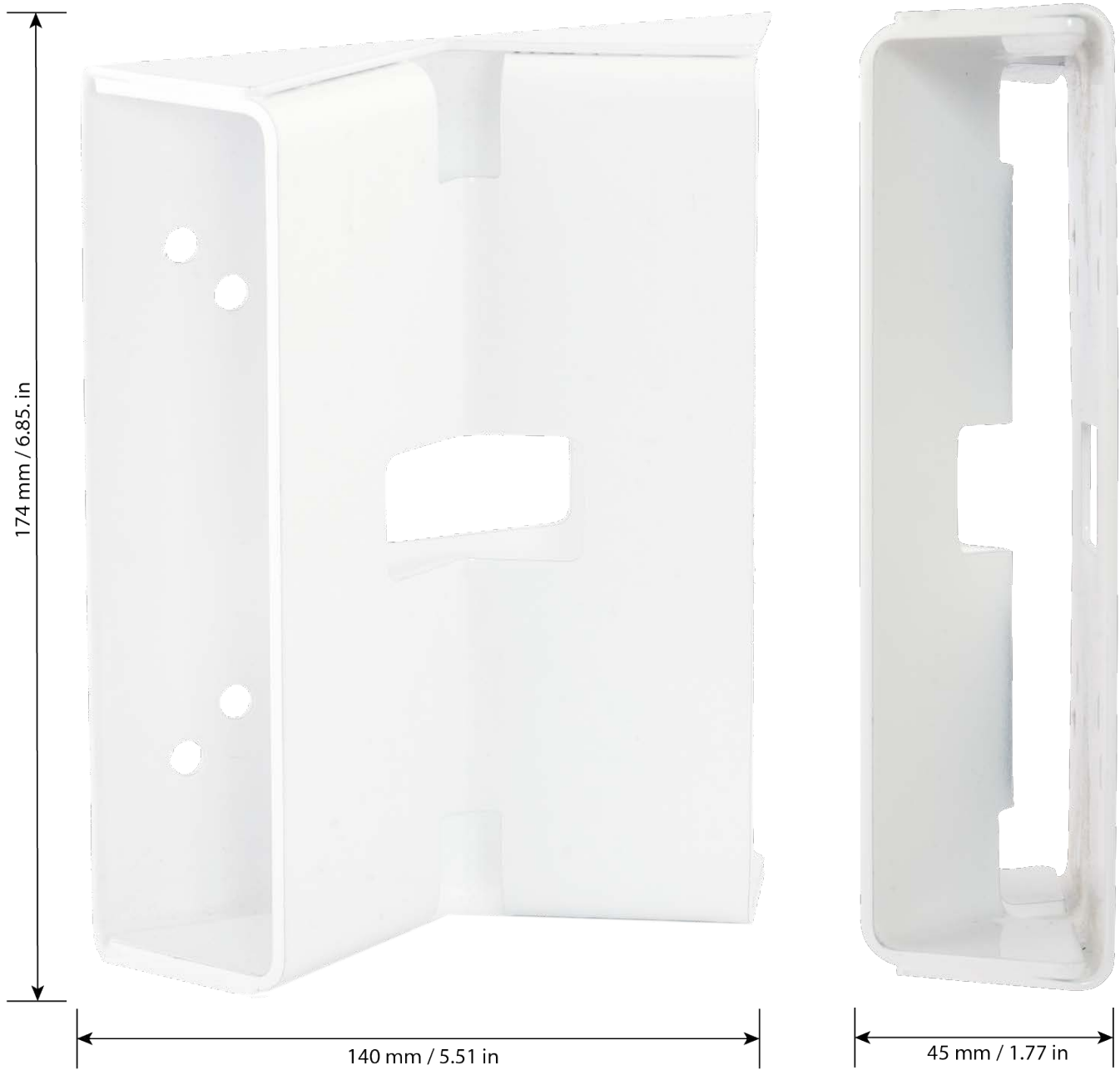

Prepare the Pole Mount

1. Guide the on-site network cable from behind through the middle opening of the pole mount.



2. Guide the two stainless steel straps along the cutouts in the Pole Mount as shown in the figure.



Mounting

Mounting Options

3. Place the straps around the pole and tighten them with a screwdriver. If necessary, the ends of the straps can be cut off.



Procedure

1. Place the white rubber wall seal with the groove on the edge of the wall mount.



2. Connect the camera to the on-site network (also see [Connecting the Camera to the Network, p. 36](#)).
3. Mount the camera to the pole mount using the four screws each with a washer.



CAUTION! Do not overtighten the screws as this may damage the plastic mount.

- Place the white plastic caps [M.3](#) on the screw heads.



Mounting to a Ceiling

The camera is per default shipped together with the VarioFlex Wall Mount, but it can be converted to a ceiling mount in a few steps by using the VarioFlex Ceiling Mount.

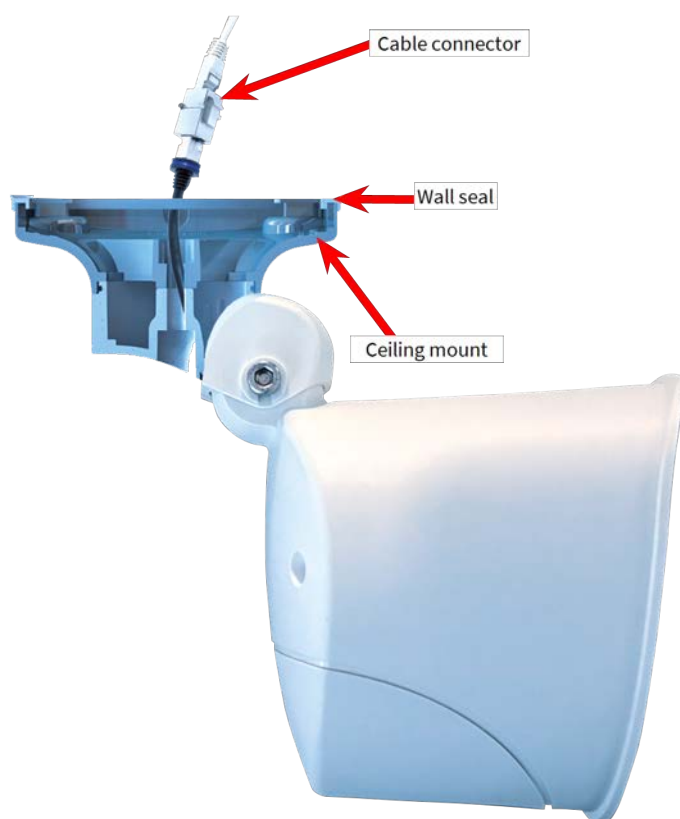

NOTE! The VarioFlex Ceiling Mount is not part of the scope of delivery and needs to be ordered separately.

Before mounting the camera, make sure that a network connection with power supply according to the PoE (802.3af-2003) standard is available at the mounting position (see [Connecting the Camera to the Network](#), p. 36).

NOTE! Download the drilling template from the MOBOTIX website: www.mobotix.com > [Support](#) > [Download Center](#) > [Marketing & Documentation](#) > [Drilling Templates](#).

CAUTION! Always print or copy the drilling template at 100% of the original size!

Mounting

Mounting Options

NOTE! Do not use the dowels if the installation surface is wood. Only use the screws to fasten the mounting plate directly on the surface. In order to facilitate screwing in wood, the positions should first be pre-drilled using a 2 mm drill bit, for example (drilling depth just slightly less than screw length).

Prepare the Camera

NOTE! The best camera position for the selected lens must be found before installing the camera on a ceiling, an overhang or balcony. You can fine-tune its position once the camera has been installed on the ceiling.

1. **Convert to a ceiling mount:** Remove the lock screw on the central joint and exchange the wall mount for the supplied ceiling mount.

2. **Install and prepare the network connection:** Guide the pre-installed camera patch cable through one of the four openings in the ceiling mount.

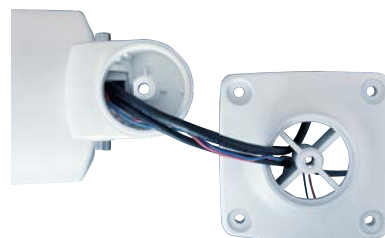

3. Fasten the ceiling mount to the central joint (using the screw of the wall mount).



Procedure

1. Mark the holes for drilling using the drilling template (see [Drilling Template, p. 11](#)).

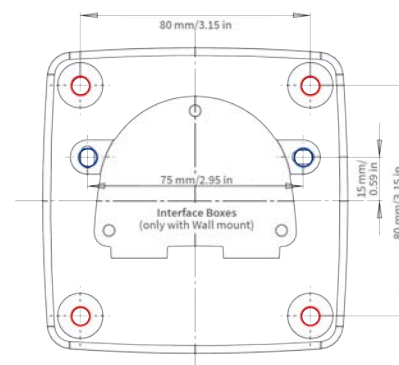

2. Drill the holes for the supplied screw anchors.

NOTE! Dowels do not have to be fitted if the surface is made of wood.

3. Fully push the dowels [M.7](#) into the holes you drilled.
4. **Attach wall seal:** Place the white rubber sealing ring with the groove on the edge of the ceiling mount.



Mounting

Adjust the Camera

5. Connect the camera to the on-site network (also see [Connecting the Camera to the Network](#), p. 36).

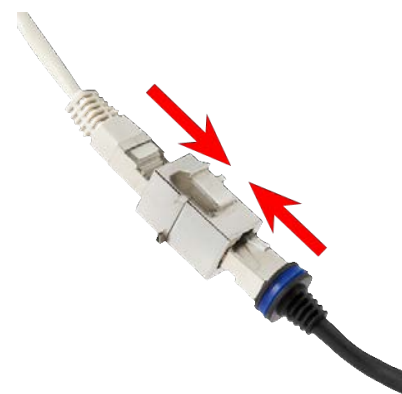

6. Mount the camera using the four screws each with a washer.



CAUTION! Do not overtighten the screws as this may damage the plastic mount.

7. Place the white caps on the screw heads.



Adjust the Camera

Adjusting the camera at the mounting position will ensure that you will see the desired field of view later on.

To finish the installation of the MOBOTIX ONE M1A-S (FIX & VARIO), the connections of the camera are established and the camera is mounted onto its final position. The installation is finished by applying the remaining cover plugs to ensure the water-proofness of the housing.

Adjust the Camera Orientation

Adjusting the camera at the mounting position will ensure that you will see the desired field of view later on.

CAUTION!

When adjusting the image focus or the field of view of the camera, always make sure that you can see the live image of the camera on your monitor.

1. Show the live image of the camera on monitor (see [Getting Started, p. 52](#)).
2. Loosen the Allen screws ① on both sides of the center pivot so that you can easily tilt the module housing.
3. Loosen the screw ② that lock the center pivot so that you can easily turn the module housing.

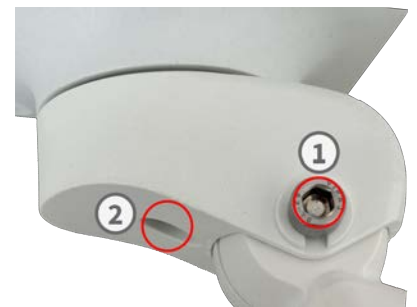

4. Display the desired camera section on the computer monitor, then turn and tilt the camera until you have found the best position and sharpness.
5. Retighten the screws ① and ① to fixate the camera position.

Adjust the Lens Focus (M1A-S Fix only)

Once the camera has been installed, the lens should be checked for proper image sharpness and manually adjusted.

The focusing aid provides a visual aid when correcting the image sharpness (see "The Live Screen of the MOBOTIX Camera" in the camera's online help).

NOTE!

When adjusting the image focus or the field of view of the camera, always make sure that you can see the live image of the camera on your monitor.

Mounting

Adjust the Camera

1. Show the live image of the camera on monitor (For more information, consult the Reference Manual of the camera.).
2. **Remove the lens protection glass:** Place the yellow lens wrench on the notches of the lens protection glass and rotate it to the left until it slides off the lens.



3. **Adjust the image sharpness:** Place yellow lens wrench (**with the ring-shaped side**) on the lens and rotate it carefully to the right or left until the image on the monitor meets your requirements.



CAUTION! Do not turn the lens too far or with force to avoid damaging the image sensor.

4. **Reinsert the protective glass:** Turn it with the yellow lens wrench to the right as far as it will go.

Operating the Camera

This section contains the following information:

Getting Started	52
Boot Options of the Camera	53
Network Settings	56

Getting Started

You can use the MOBOTIX ONE M1A-S (FIX & VARIO) with any current browser – or with MxManagementCenter.

You can download MxManagementCenter free-of-charge from www.mobotix.com > [Support](#) > [Download Center](#) > [Software Downloads](#).

1. **Connect the camera to the network.** The network cable will also provide power to the camera.
 1. **Establish a connection to the camera and adjust the network settings if required:** By factory default, MOBOTIX cameras are booting as DHCP client with an additional fixed IP address in the 10.x.x.x range (e.g.: 10.16.0.128). Local computer networks usually have IP addresses in the 172 or 192 ranges. Depending on whether a DHCP server is present on the local network or if the network has been set up to use fixed IP addresses, there are several possibilities for establishing a connection to the camera and to change its Network Settings:
 - **Network with dynamic IP addresses**

Using a web browser: If you know the IP address that the DHCP server assigned to the camera, simply enter that address in the browser address bar to directly connect to the camera (see [Network Settings on the Camera in the Web Browser](#), p. 59)

Using MxManagementCenter: With MxManagementCenter, you can find and integrate the camera without having to know the current IP address of the camera (see [Network Settings on the Camera in MxMC](#), p. 58).
 - **Network with static IP addresses**

In order to access the camera, it must have an IP address within the range of the local network. To set the camera's network parameters, you can use one of these methods:

Manually using a web browser: You may have to adjust the network settings of your computer (see [Manual Setup](#), p. 56).

Automatically using MxManagementCenter: The camera is displayed in MxMC although the IP address is not part of the local network, allowing you to reconfigure its settings [Network Settings on the Camera in MxMC](#), p. 58.
 2. **Configure camera:** You can use the user interface of the camera in a browser or in MxManagementCenter.

LED states

Camera LED on top of the camera body displays the following states by default:



LED status	Meaning
green steady on	normal operation
green steady flashing	technical error or misconfiguration

Boot Options of the Camera

By default, the camera starts as DHCP client and automatically tries to get an IP address from a DHCP server. To start the camera in a mode different from the default mode, you can activate the boot menu of the camera.

NOTE! Pressing the key of the camera will let the camera announce the current IP address of the camera on the speaker.

1. Disconnect the camera's power supply.
2. Open the camera housing (see [Opening the Camera Housing, p. 30](#)).

Operating the Camera

Boot Options of the Camera

3. Remove the screw cap ① from the microSD card housing with a screwdriver.



4. Take a suitable tool for operating the boot menu (e.g. the enclosed tweezers [ONE M1A-S \(FIX & VARIO\): Scope of Delivery, p. 14.](#)) **but do not use a paper clip or pointed objects!**
5. Reconnect the power supply of the camera.
6. **Activate the boot menu:** The LED at the front of the camera lights up 5 to 10 seconds after establishing the power supply and will stay on for 10 seconds. Press the reset key ② with the tool into the hole. The camera enters the boot menu, ready for selecting one of the boot options. The LED will flash once. The flash signal will be repeated every second.



NOTE! The number of flashes corresponds to the current boot option.

7. **Switch the boot option:** Briefly press the reset button (< 1 sec). After the last boot option, the camera returns to the first boot option (LED flashes once).

LED flashes	Boot Option	Meaning	Audio Confirmation
1x	•/•	This option is not supported on this camera model.	•/•
2x	Factory Defaults	Starts the camera with factory defaults (factory default IP address, users and passwords will not be reset).	Boing

LED flashes	Boot Option	Meaning	Audio Confirmation
3x	Automatic IP Address	Starts the camera as DHCP client and tries to obtain an IP address from a DHCP server. If a DHCP server cannot be found or no IP address can be obtained, the camera starts with its factory default address.	Boing-Boing
4x	Recovery System	Starts the camera with the recovery system, e.g., in order to recover from a failed update of the camera software.	Alarm Sound

8. **Select a boot option:** Press the key longer (> 2 sec). The camera confirms the selection by flashing the LED rapidly for 3 seconds. After 20 sec, the camera will play a sound according to the table above.
9. Close the camera housing (see [Closing the Camera Housing, p. 31](#)).

NOTE! If you do not select a boot option, the camera will resume its normal boot process after a certain time.

CAUTION!

Note that you can restore specific parts of the camera configuration afterwards by using "Restore" to re-apply the settings still stored in the camera.

As opposed to resetting the camera using **Admin Menu > Reset configuration to factory defaults**, the user information will not be reset if the camera is booted using the factory defaults.

When starting the camera with DHCP support (option 2), make sure that the network has a properly functioning DHCP server. If this is not the case, the camera cannot obtain a valid IP address and will fall back to its last IP address.

You should also make sure that the cameras always get the same IP addresses by mapping the MAC addresses of the cameras to the desired IP addresses.

Network Settings

Once the camera has been connected to the network, you need to check and if required adjust the network parameters of the camera.

If your network has an active DHCP server or if it is already running on a 10.x.x.x network with a 255.0.0.0 network mask) you do not need to change the camera's network parameters. You can directly access the camera.

If there is no DHCP server running and neither your network nor your computer use an IP address in the 10.x.x.x network (e.g. a 192.168.x.x or 172.x.x.x), you should follow one of the following methods to connect the camera to your network:

- Manual setup
- Automatic setup using MxManagementCenter

NOTE! For the following examples, we will use a camera with the factory IP address 10.16.0.99. Replace this IP address with the IP address of your camera. You will find this address on a small sticker on the camera. Make sure that the IP addresses used in the following examples are not used by any other devices on your network.

Manual Setup

This section describes how to configure your computer to a fixed local network address that corresponds to the IP address range of the camera.

Windows

1. Open the Windows **Control Panel > Network and Internet > Network and Sharing Center > Change Adapter Settings > Ethernet.**

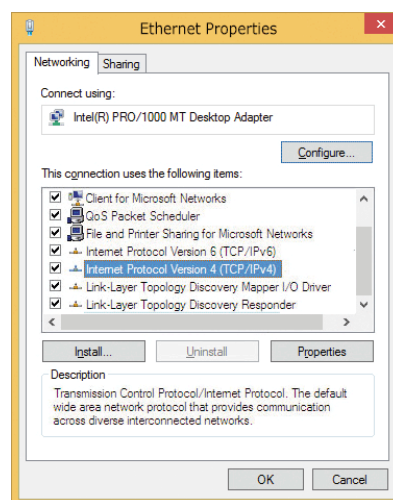

2. Right-click on the relevant network adapter and select **Properties**.
3. Open the properties of **Internet Protocol Version 4 (TCP/IPv4)**.



4. Activate **Use the following IP-address**. Enter an IP address in the 10.x.x.x range field (e.g. 10.16.0.11) and the subnet mask 255.0.0.0..
5. Click on **OK** to apply the settings.

Mac

1. Open **System Settings > Network**.



2. Click on **Ethernet** and in the **Configuration** field, select the *Manual* list entry and enter an IP address in the 10.x.x.x IP address range (e.g., 10.16.0.11) and a Subnet Mask 255.0.0.0.
3. Click on **Apply** to apply the settings.

Linux / Unix

1. Open a terminal as `root` user.
2. Enter the following command: `ifconfig eth0:1 10.16.0.11.`
3. The computer now has the additional IP address 10.16.0.11.

Automatic Setup using MxManagementCenter

This section describes how to use MxMC to connect the camera and configure its network settings.

MxManagementCenter is a video management software for setting up and using the entire video surveillance system that provides a range of functions for different tasks and user groups. You can download the newest release of MxManagementCenter from the MOBOTIX website (www.mobotix.com > Support > Download Center > Software Downloads, MxManagementCenter section).

Network Settings on the Camera in MxMC

When starting MxManagementCenter for the first time, the configuration wizard opens and automatically starts searching for MOBOTIX cameras. The number of detected cameras is shown next to the **Add Devices** icon.

1. Click on **Add Devices**. The cameras are displayed either in a list or as tiles. Use the List and Tile buttons to change the display mode.



The application automatically monitors and displays the operating status of all cameras using corresponding icons.



EXAMPLE:

- The camera is not in the same subnet as the computer.
- The user name and password of the camera are not known.

NOTE! Using the Bonjour service ([en.wikipedia.org/wiki/Bonjour_\(software\)](http://en.wikipedia.org/wiki/Bonjour_(software))), the application finds not only MOBOTIX cameras on the same subnet, but also in other subnets. Normally, you would not be able to establish any connection to cameras in a different network or subnet.

NOTE! This is the case, for example, if you are integrating cameras into a network without DHCP server (i.e. with fixed IP addresses) and the IP address range is different from the 10.x.x.x range supported by the cameras in addition to DHCP.

MxManagementCenter can automatically configure such a camera so that it is "integrated" into your existing network.

2. Select the camera you want to set up and click on **Edit Network Settings**  at the bottom of the program window. The **Change Network Settings for Selected Devices** dialog opens.



3. Enter the IP address and the subnet mask of the selected camera.

NOTE! The IP addresses of the other cameras are automatically incremented by 1.

4. Click on **Apply** to apply the settings.

NOTE! For more information on this feature, please read the MxManagementCenter online help or the Tutorial (see www.mobotix.com > Support > Download Center > Documentation > Brochures & Guides > Tutorials).

Network Settings on the Camera in the Web Browser

1. Use a web browser to access the web interface of the MOBOTIX camera and enter the factory IP address (e.g. 10.16.0.99).

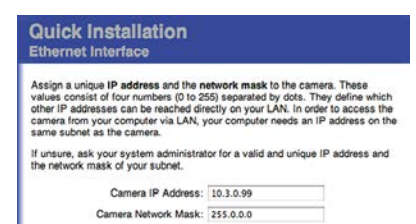

2. Click on the **Admin Menu** button in the user interface of the camera. The Quick Installation automatically starts after entering the access credentials of the admin user.

NOTE! Factory access credentials:

*User name:*admin

*Password:*meinsm

NOTE! You can also run the Quick Installation later on (**Admin Menu > Network Configuration > Quick Installation**; see Reference Manual).

3. Enter the network parameters of the camera in the course of the quick installation.

NOTE! You can also change the network parameters later on by running **Admin Menu > Network Configuration > Quick Installation**.

4. Reboot the camera to apply the network settings.

Camera Software in the Browser

The integrated software of the MOBOTIX ONE M1A-S (FIX & VARIO) features a multitude of functions, such as video motion detection, long-term recording, alarm messaging and video IP telephony. Especially remarkable are the AI-based analytics features and the possibility to install third-party apps on the camera. Thanks to the virtual PTZ features, you can continuously zoom into or out of the live image using either the mouse wheel or a joystick.

When recording images or video sequences, you can choose to store either the visible image area of the live image or the full sensor image. This also allows examining the parts of an image or video that had not been visible in the real-time image section on display at the time of the recording.

Instead of using a web browser, you can also download the free MxManagementCenter from the MOBOTIX website (www.mobotix.com > Support), which allows displaying multiple cameras on one monitor, allows for comfortably searching and evaluating the alarm video clips with audio and provides alerting features. For mobile iOS and Android devices, the free-of-charge MOBOTIX LIVE App is available.

This section contains the following information:

Access the Camera in the Web Browser	62
Basic Settings	62

Access the Camera in the Web Browser

Once the power and network connection of the MOBOTIX have been established, you can access the interface of the camera software in a web browser.

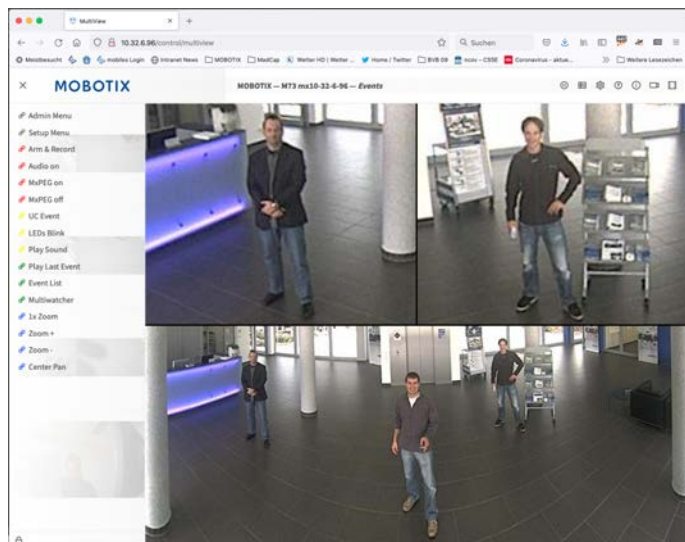

1. Enter the camera's IP address in the address field of a web browser.

NOTE! You can find the IP address of the camera, for example, in the camera housing or on the sticker on the packaging.

Basic Settings

Password for the Administration Menu: Accessing the administration area of the camera (Admin Menu button) in the browser is only possible after entering a user name and password.

- **Default user name:** admin
- **Default password:** meinsm

NOTE! You must change the password when logging in for the first time.

CAUTION! Make sure that you store information on user names and passwords in a secure place. If you lose the administrator password and cannot access the Administration menu, the password can only be reset at the factory. This service is subject to a service charge.

The Quick Installation wizard will appear automatically when accessing the Administration Menu for the first time. It provides an easy method to adjust the basic camera settings to the current application scenario. For

security reasons, it is highly recommended to change the default administrator password after the camera has been configured properly.

Administering the camera: You can modify the camera configuration in the Administration Menu or the Setup Menu:

- **Admin Menu:** This menu contains the basic configuration dialogs of the camera (e.g. passwords, interfaces, software update).
- **Setup Menu:** This menu contains the dialogs for configuring the image, event and recording parameters. Some of these settings can be changed using the corresponding Quick Controls in the Live screen.

NOTE! For more information, consult the Reference Manual of the camera.

Maintenance

Replacing the microSD Card	66
Cleaning the Camera and Lenses	67

Replacing the microSD Card

CAUTION!

Before removing the microSD card, deactivate the recording function and restart the camera. Non-observance can lead to data loss!

The microSD card must not be write-protected!

Do not touch the circuit board when exchanging the microSD card!

Step by step

1. **Deactivate storage:** If storage on microSD card is still activated deactivate it in the camera's web interface: **Admin Menu > Storage on external file server / flash media**, then reboot the camera .
2. **Open the housing:** (see [Opening the Camera Housing, p. 30](#)).
3. **Open the screw cap:** Using a coin or wide screwdriver, release the screw cap ① and remove it.



4. **Remove the microSD card:** Gently push the microSD card downwards to release it from the push lock. Then pull it out with tweezers.



5. **Insert microSD card:** Carefully insert the new microSD into the slot using tweezers and press it in lightly until it clicks into place.
6. **Close the screw cap:** Reinsert the screw cap and close it using a coin or a wide screwdriver.
7. **Close the housing:** (see [Closing the Camera Housing, p. 31](#)).
8. **Activate storage:** If the microSD card already is formatted with MxFFS, storage can be activated in Admin Menu > Storage on External File Server/Flash Device. Otherwise the microSD card must be formatted at first. After rebooting the camera, recording is activated automatically. .

Cleaning the Camera and Lenses

Clean the camera housing using a mild alcohol-free detergent without abrasive particles.

To clean the lenses use a lint-free soft cloth. Make sure that the lens is still in focus after cleaning and adjust the lens' focus if required (see [Adjust the Lens Focus \(M1A-S Fix only\)](#), p. 49).

CAUTION! To protect the lens protection glass, only use the supplied mounting supplies (see [Mounting Supplies: Scope of Delivery](#), p. 15).

MOBOTIX

BeyondHumanVision

[EN_10/24](#)

MOBOTIX AG • Kaiserstrasse • D-67722 Langmeil • Tel.: +49 6302 9816-103 • sales@mobotix.com • www.mobotix.com

MOBOTIX is a trademark of MOBOTIX AG registered in the European Union, the U.S.A., and in other countries. Subject to change without notice. MOBOTIX do not assume any liability for technical or editorial errors or omissions contained herein. All rights reserved. © MOBOTIX AG 2019