

Quick Installation

MOBOTIX MOVE 5MP Vandal Fixed Dome Analytics Camera Mx-VD2A-5-IR-VA

© 2024 MOBOTIX AG

NOTE!

This guide is only valid for **installing and connecting** the 5MP Vandal Fixed Dome Analytics Camera. For more information on the camera, please refer to the other documents (see [Further Reading, p. 8](#)).

Important Installation Notes

- This camera must be installed by qualified personnel and the installation should conform to all local codes.
- This product must not be used in locations exposed to the dangers of explosion.
- Do not look directly into the infra-red LEDs that may be active on the product.
- Do not use this product in a dusty environment.
- Protect this product from moisture or water entering the housing.
- Install this product as outlined in this document. A faulty installation can damage the product!
- Do not replace batteries of the camera. If a battery is replaced by an incorrect type, the battery can explode.
- This equipment is not suitable for use in locations where children are likely to be present.
- External power supplies must comply with the Limited Power Source (LPS) requirements and share the same power specifications with the camera.
- When using a power adapter, the power cord shall be connected to a socket-outlet with proper ground connection.
- To comply with the requirements of EN 50130-4 regarding the power supply of alarm systems for 24/7 operation, it is highly recommended to use an uninterruptible power supply (UPS) for backing up the power supply of this product.

NOTE! Observe the [MOBOTIX MOVE Installation Hints](#) document to ensure optimum performance of the camera features.

Camera Connectors

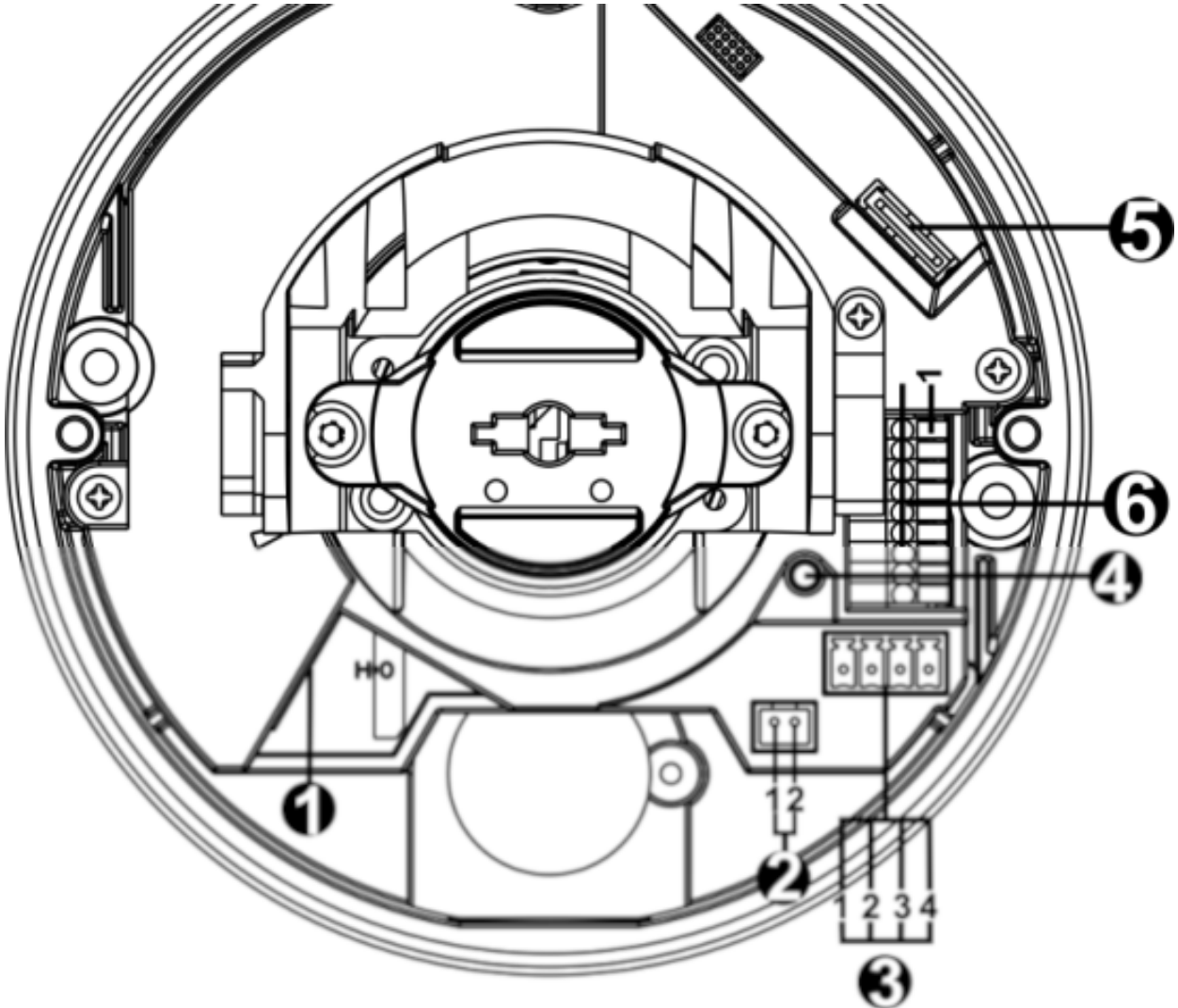

No.	Connector	Pin	Definition	Remarks
1	RJ-45	-	For network and PoE connections	
2	BNC*	1	BNC	For analog video output
		2	GND	
3	Power (AC24V/DC12V)	1	AC 24V 1	Power connection
		2	AC 24V 2	
		3	DC 12V 1	
		4	DC 12V 2	

No.	Connector	Pin	Definition	Remarks
4	Reset Button	-		Press the button with a proper tool for at least 20 seconds to restore the camera.
5	microSD Card Slot	-		Insert the microSD card into the card slot to store videos and snapshots. Do not remove the microSD card when the camera is powered on.
6	Alarm & Audio I/O	1	Audio In L	Audio In (Line In)
		2	Audio In R	
		3	GND	Ground connection
		4	Audio Out L	Audio Out (Line Out)
		5	Audio Out R	
		6	Alarm Out +	Alarm connection
		7	Alarm Out -	Do NOT connect external power supply to the alarm I/O connector of the IP camera.
		8	Alarm In +	
		9	Alarm In -	

*Contact the manufacturer for the compatible BNC cable.

microSD Card Slot/Reset Button

CAUTION! Always power down the camera before performing the following steps!

microSD Card Slot

CAUTION! Always power down the camera before performing the following steps!

Insert a microSD card into the card slot to store videos and snapshots.

NOTE!

- It is not recommended to record with the microSD card for 24/7 continuously, as it may not be able to support long term continuous data read/write. Contact the manufacturer of the microSD card for information regarding the reliability and the life expectancy.
- Remember to format a new microSD card as shown in [Formatting Storage Media](#) below.

Reset Button

Press the reset button with a proper tool for at least 20 seconds to restore the system.

Connecting Power

Using Power over Ethernet (PoE)

Use a PoE switch (Class 0) and connect the Ethernet cable to the RJ-45 port of the camera.

Using AC or DC

To power up the camera, connect **either the AC or the DC** power adapter to the power connector of the camera and the power outlet.

CAUTION! Never connect both AC and DC power since **this will cause unforeseeable damage.**

Zero Downtime Power Switching (ZDT)

If the camera is connected to two power sources, it will switch the power input seamlessly in this order:

- **AC and PoE connected:** AC > PoE
- **DC and PoE connected:** PoE > DC

CAUTION! Never connect both AC and DC power since **this will cause unforeseeable damage.**

Ethernet Cable Connection

Connect one end of the Ethernet cable to the RJ-45 connector of the camera and plug the other end of the cable into the network switch or PC.

NOTE!

- The length of the Ethernet cable should not exceed 100 m/300 ft.
- Check the status of the link indicator and the activity indicator LEDs of the switch. If the LEDs are unlit, please check the LAN connection.
- In some cases, an Ethernet crossover cable may be needed when connecting the camera directly to the PC.

Ethernet Connector LEDs

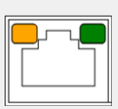

- Green **Link** LED indicates good network connection.
- Orange **Activity** LED flashes to indicate network activity.

NOTE! The ITE is to be connected only to PoE networks without routing to the outside plant or equivalent description.

Accessing the Camera

The 5MP Vandal Fixed Dome Analytics Camera supports all current browsers without requiring any additional plug-ins or add-ons (e.g. for H.264/H.265/MJPEG support).

Camera Login

The default IP address of the camera is: 10.x.x.x. By default, the camera starts as DHCP client and automatically tries to get an IP address from a DHCP server.

1. Enter the camera's IP address in the URL bar of the web browser and hit "Enter".
2. Enter the default username (**admin**) and password (**meinsm**).

NOTE! User names and passwords are case sensitive.

3. You will be prompted to set a new admin user password.

NOTE! The password can have between 6 and 14 characters (at least one digit, no special characters allowed).

4. After setting a new password, you will be prompted to log in again. Remember to use the new password.

Browser-Based Viewer

The main page of the IP camera user interface is shown as the figure below. The function buttons vary depending on the camera model.

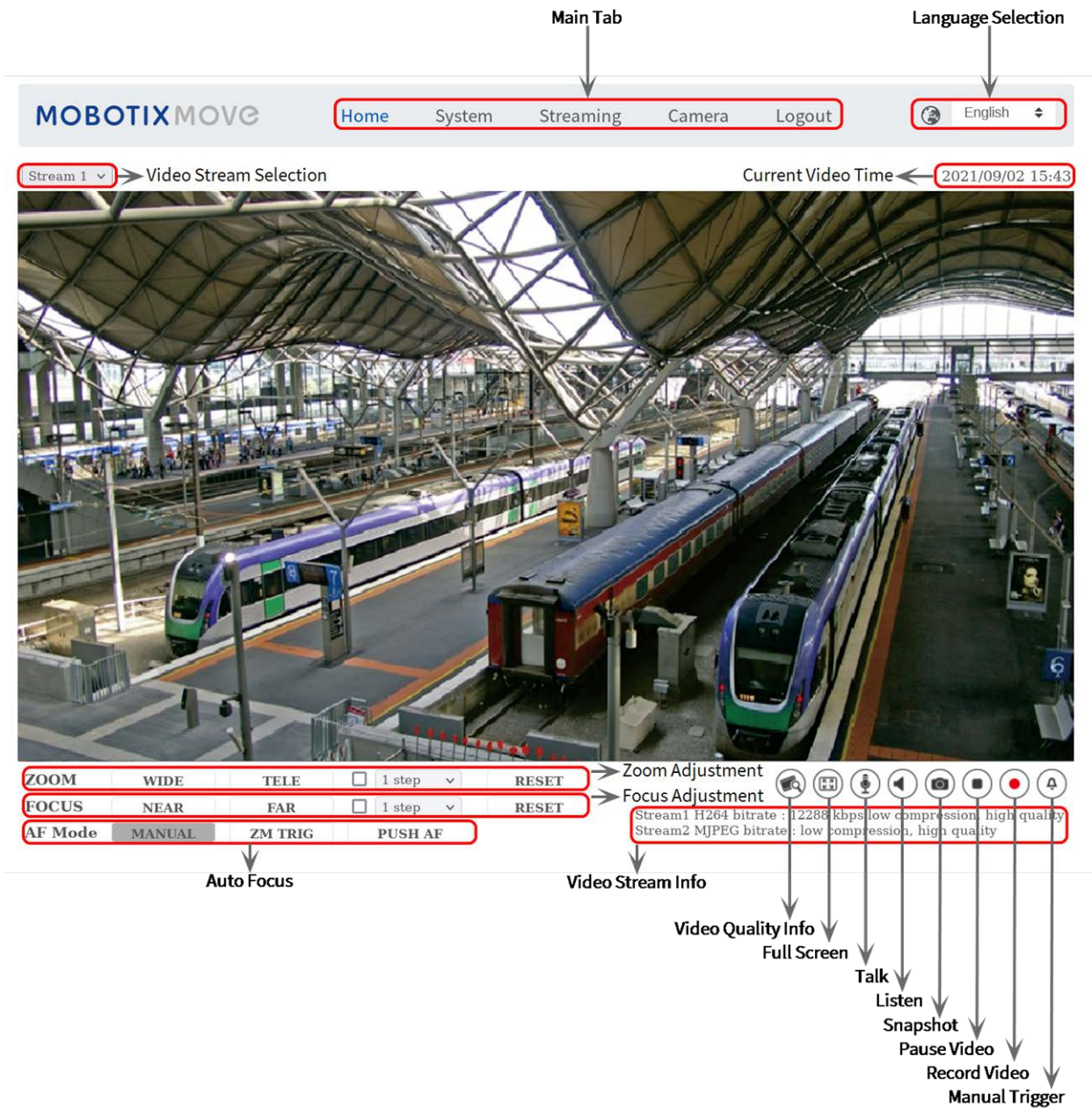

Formatting Storage Media

After inserting a new or replacing a used storage medium, make sure to format the medium so the camera can use it to record video streams.

1. Connect to the camera.
2. Open **System > Storage Management > <storage media type>**.
3. In the **Device Setting** section, click on **Format** to start the formatting process.

Once formatting has finished, the camera can use the storage medium for recording.

Camera Maintenance

It is recommended that you perform the following maintenance tasks at regular intervals to keep the 5MP Vandal Fixed Dome Analytics Camera in good working condition:

- Clean the dome using plain water and a soft cloth.

CAUTION! Do not use any detergents or alcohol to prevent damaging the coating!

- Check the mounting and make sure that all screws are properly tightened to prevent the camera from falling down.
- When opening the camera, add a silica gel dry pack to prevent condensation on the inside of the dome.

Further Reading

[Manuals and Quick Installation documents](#)



[Video Analytics Manual](#)



[Technical Specifications](#)



[MOBOTIX MOVE Installation Hints](#)



[MOBOTIX Community](#)



MOBOTIX

BeyondHumanVision

EN_10/24

MOBOTIX AG • Kaiserstrasse • D-67722 Langmeil • Tel.: +49 6302 9816-103 • sales@mobotix.com • www.mobotix.com

MOBOTIX is a trademark of MOBOTIX AG registered in the European Union, the U.S.A., and in other countries. Subject to change without notice. MOBOTIX do not assume any liability for technical or editorial errors or omissions contained herein. All rights reserved. © MOBOTIX AG 2020