























MOBOTIX MOVE

Camera product portfolio



Model	Bullet	Fix Dome	Turret	Hemispheric	Multisensor	PTZ Dome
B Series	 SX BC2A-2-IR	 SX VD2A-2-IR  UX MD1A-5-IR	 TU VT1A-2-IR  TU VT1A-5-IR  TU VT1A-203-IR  TU VT1A-503-IR			
S Series	 SX VB3A-2-IR-VA  SX VB2A-5-IR-VA	 SX VD3A-2-IR-VA  SX VD2A-5-IR-VA		 UX VH1A-12-IR-VA	 SX VM1A-20-IR-VA	 UX SD2A-230-LL (-FM)  UX SD1A-540-IR  UX SD1A-540-IR
E Series	 UX VB1A-8-IR-VA  UX VB-2-IR-ALPR  UX VB-2-IR-D-ALPR	 UX VD1A-8-IR-VA			 ES VMSD1A-20-VA	 UX SD1A-831-LIR

Model line

- B** Base
- S** Standard
- E** Extended

Firmware (HW platform-based)

- NX** **BX** **UX** **ES**
- SX** **TU** **YX**

Model number

Mx-VH1A-12-IR-VA

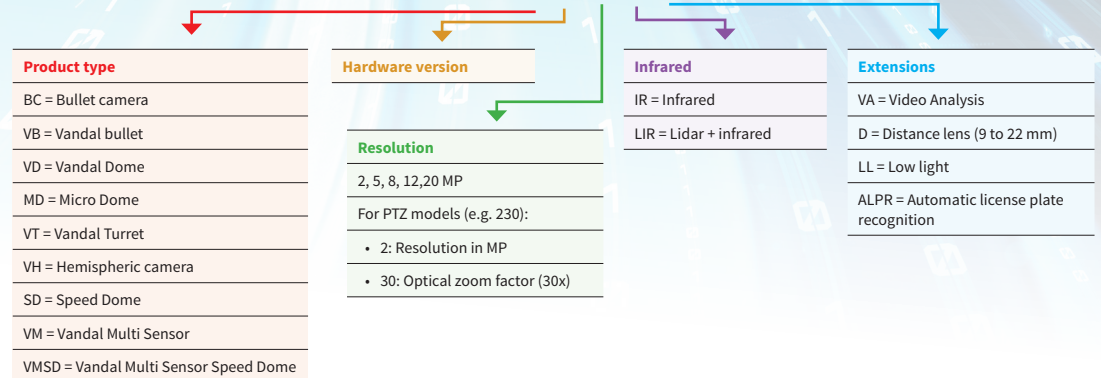

MOBOTIX AG • Kaiserstrasse • 67722 Langmeil • Germany
+49 (0) 6302 9816-103 • sales@mobotix.com • www.mobotix.com

MOBOTIX is a registered trademark of MOBOTIX AG in the European Union, the USA, and other countries. This may only be transferred to trade or commercial partners. Subject to change. MOBOTIX does not assume any liability for technical errors, printing errors or omissions. All rights reserved. © MOBOTIX AG 2024 (EN_02/24)

MOBOTIX MOVE