

# Quick Installation

**MOBOTIX v71**

© 2024 MOBOTIX AG



BeyondHumanVision

**MOBOTIX**

V1.36, 8/7/2024, Order Code: Mx-v71A-8DNxxx/Mx-v71A-4DNxxx

# Table of Contents

---

<b>Table of Contents</b> .....	<b>2</b>
<b>Before You Start</b> .....	<b>5</b>
Support .....	6
MOBOTIX Support .....	6
MOBOTIX eCampus .....	6
MOBOTIX Community .....	6
Safety Notes .....	7
Legal Notes .....	7
<b>Notes on System Security</b> .....	<b>9</b>
<b>Protective Measures</b> .....	<b>10</b>
Notes on Cable Laying .....	10
Fire Protection .....	10
Lightning and Surge Protection .....	11
<b>Drilling Template</b> .....	<b>13</b>
Drilling Template v71 .....	14
<b>Scope of Delivery</b> .....	<b>19</b>
MOBOTIX v71: Scope of Delivery .....	20
Mounting Supplies: Scope of Delivery .....	21
Wall Mount: Scope of Delivery .....	22
In-Ceiling Set: Scope of Delivery .....	23
<b>Technical Specifications</b> .....	<b>25</b>
Order Information .....	26
Hardware .....	26
Image and Video Properties .....	27
General Software Features .....	28
Video Analysis .....	29
Video Management Software .....	29
Dimensions .....	30
In-Ceiling Set D7x_Q7x .....	31
<b>Mounting</b> .....	<b>33</b>
Adjusting the Camera Lens .....	34
Removing the Dome .....	34
Focusing the Camera Lens .....	35
Attaching the Anti Glare Ring .....	37
Attaching the dome .....	38

---

Mounting Options .....	38
Mounting the Camera Without Accessories .....	39
Mounting with the On-Wall Set .....	40
Mounting with the In-Ceiling Set .....	45
Mounting with the Wall Mount .....	47
Mounting on a Corner (Corner/Pole Mount) .....	49
Mounting on a Pole (Corner/Pole Mount) .....	51
Connecting the Camera .....	52
Connecting a USB-C Device .....	52
Connecting the Camera to the Network .....	53
<b>Operating the Camera .....</b>	<b>55</b>
Getting Started .....	56
Boot Options of the Camera .....	56
Network Settings .....	59
Windows .....	60
Mac .....	61
Linux / Unix .....	61
Network Settings on the Camera in the Webbrowser .....	61
Network Settings on the Camera in MxMC .....	62
<b>Camera Software in the Browser .....</b>	<b>65</b>
Access the Camera in the Web Browser .....	66
Basic Settings .....	66
<b>Maintenance .....</b>	<b>69</b>
Replacing the microSD card .....	70
Cleaning the Camera .....	71



## Before You Start

This section contains the following information:

<b>Support</b> .....	<b>6</b>
<b>Safety Notes</b> .....	<b>7</b>
<b>Legal Notes</b> .....	<b>7</b>

# Support

## MOBOTIX Support

If you need technical support, please contact your MOBOTIX dealer. If your dealer cannot help you, he will contact the support channel to get an answer for you as quickly as possible.

If you have internet access, you can open the MOBOTIX help desk to find additional information and software updates.

Please visit [www.mobotix.com](http://www.mobotix.com) > [Support](#) > [Help Desk](#).



## MOBOTIX eCampus

The MOBOTIX eCampus is a complete e-learning platform. It lets you decide when and where you want to view and process your training seminar content. Simply open the site in your browser and select the desired training seminar.

Please visit [www.mobotix.com/ecampus-mobotix](http://www.mobotix.com/ecampus-mobotix).



## MOBOTIX Community

The MOBOTIX community is another valuable source of information. MOBOTIX staff and other users are sharing their information, and so can you.

Please visit [community.mobotix.com](http://community.mobotix.com).



## Safety Notes

- This camera must be installed by qualified personnel and the installation should conform to all local codes.
- This product must not be used in locations exposed to the dangers of explosion.
- Do not use this product in a dusty environment.
- Protect this product from moisture or water entering the housing.
- Install this product as outlined in this document. A faulty installation can damage the product!
- Do not replace batteries of the camera. If a battery is replaced by an incorrect type, the battery can explode.
- This equipment is not suitable for use in locations where children are likely to be present.
- External power supplies must comply with the Limited Power Source (LPS) requirements and share the same power specifications with the camera.
- When using a power adapter, the power cord shall be connected to a socket-outlet with proper ground connection.
- To comply with the requirements of EN 50130-4 regarding the power supply of alarm systems for 24/7 operation, it is highly recommended to use an uninterruptible power supply (UPS) for backing up the power supply of this product.

## Legal Notes

### Legal Aspects of Video and Sound Recording

You must comply with all data protection regulations for video and sound monitoring when using MOBOTIX AG products. Depending on national laws and the installation location of the cameras, the recording of video and sound data may be subject to special documentation or it may be prohibited. All users of MOBOTIX products are therefore required to familiarize themselves with all applicable regulations and to comply with these laws. MOBOTIX AG is not liable for any illegal use of its products.

### Declaration of Conformity

The products of MOBOTIX AG are certified according to the applicable regulations of the EC and other countries. You can find the declarations of conformity for the products of MOBOTIX AG on [www.mobotix.com](http://www.mobotix.com) under **Support > Download Center > Marketing & Documentation > Certificates & Declarations of Conformity**.

## RoHS Declaration

The products of MOBOTIX AG are in full compliance with European Unions Restrictions of the Use of Certain Hazardous Substances in Electrical and Electronic Equipment (RoHS Directive 2011/65/EC) as far as they are subject to these regulations (for the RoHS Declaration of MOBOTIX, please see [www.mobotix.com](http://www.mobotix.com), **Support > Download Center > Marketing & Documentation > Brochures & Guides > Certificates**).

## Disposal

Electrical and electronic products contain many valuable materials. For this reason, we recommend that you dispose of MOBOTIX products at the end of their service life in accordance with all legal requirements and regulations (or deposit these products at a municipal collection center). MOBOTIX products must not be disposed of in household waste! If the product contains a battery, please dispose of the battery separately (the corresponding product manuals contain specific directions if the product contains a battery).

## Disclaimer

MOBOTIX AG does not assume any responsibility for damages, which are the result of improper use or failure to comply to the manuals or the applicable rules and regulations. Our General Terms and Conditions apply. You can download the current version of the **General Terms and Conditions** from our website at [www.mobotix.com](http://www.mobotix.com) by clicking on the corresponding link at the bottom of every page.

It is the User's responsibility to comply with all applicable local, state, national and foreign laws, rules, treaties and regulations in connection with the use of the Software and Product, including those related to data privacy, the Health Insurance Portability and Accountability Act of 1996 (HIPPA), international communications and the transmission of technical or personal data.

## FCC Disclaimer

This equipment has been tested and found to comply with the limits for a Class A digital device, pursuant to part 15 of the FCC Rules. These limits are designed to provide reasonable protection against harmful interference when the equipment is operated in a commercial environment. This equipment generates, uses, and can radiate radio frequency energy and, if not installed and used in accordance with the instruction manual, may cause harmful interference to radio communications. Operation of this equipment in a residential area is likely to cause harmful interference in which case the user will be required to correct the interference at his own expense.



# Notes on System Security

To protect the camera against security risks in data technology, the following measures are recommended after the installation has been completed:

MxManagementCenter:

- Menu **View > Wizards & Tools > Secure System:**
  - **Change camera factory default password:** ✓
  - **Enable encrypted HTTPS:** ✓
  - **Disable public access:** ✓
  - **User Management** (for all users):
    - **Force Complex Password:** ✓
    - **Log out on Inactivity:** After 5 min

User interface of the camera in the browser:

- **Admin Menu > Network Setup > Web Server:**
  - **Enable MxWeb:** –
  - **Enable intrusion detection:** ✓
  - **Notification threshold:** 10
  - **Timeout:** 60 minutes
  - **Block IP Address:** ✓

For more information on this new feature, please read the «Cyber Protection Guide» on [www.mobotix.com](http://www.mobotix.com) (under Support > Download Center > Documentation > Brochures & Guides > Cyber Security).

# Protective Measures

**WARNING!** When laying cables indoors and outdoors, the current regulations for cable laying, lightning and fire protection must always be observed.

MOBOTIX cameras and devices are protected against the effects of minor over voltages by a number of measures. However, these measures cannot prevent larger surge voltages from causing damage to the camera. When installing the cameras outdoors, special attention should therefore be paid to lightning protection and the associated dangers for the building and network infrastructure.

In general, you should only have MOBOTIX cameras and devices installed by certified specialist companies that are familiar with the installation and safe operation of network devices and the underlying regulations for lightning and fire protection as well as the current technology for preventing damage from surge voltages.

## Notes on Cable Laying

- **Data cable:** Only double-shielded CAT5 cable or better (S/STP) may be used as data cable for the Ethernet interface.

**NOTE!** For outdoor use, special requirements apply for the cables to be used and the lightning protection.

- **Cable length:** The individual cable sections must not exceed the maximum permissible lengths in order to ensure perfect data transmission.
- **Avoidance of induction:** Data cables may only be laid parallel to power or high-voltage lines if the prescribed minimum distances are observed.
- Only use MOBOTIX cables and connectors to ensure IP66 weather resistance.

## Fire Protection

When laying cables for the power supply, the relevant country-specific regulations (e.g. VDE in Germany) and the fire protection regulations valid at the installation site must be observed.

# Lightning and Surge Protection

Measures should always be taken to protect this device from electrical surge damage.

**NOTE!** Electrical surge protection available using the MX-Overvoltage-Protection-Box, which is available as an accessory.

Further information on how to avoid damage caused by lightning and over voltage is available from manufacturers of lightning and over voltage protection devices.





## Drilling Template

Open this file in a PDF viewer (Acrobat Reader, Foxit Reader, or similar) and print the file **without scaling (original size)**.

**NOTE!** Download the drilling template from the MOBOTIX website: [www.mobotix.com](http://www.mobotix.com) > [Support](#) > [Download Center](#) > [Marketing & Documentation](#) > [Drilling Templates](#).

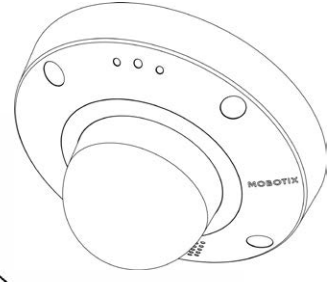
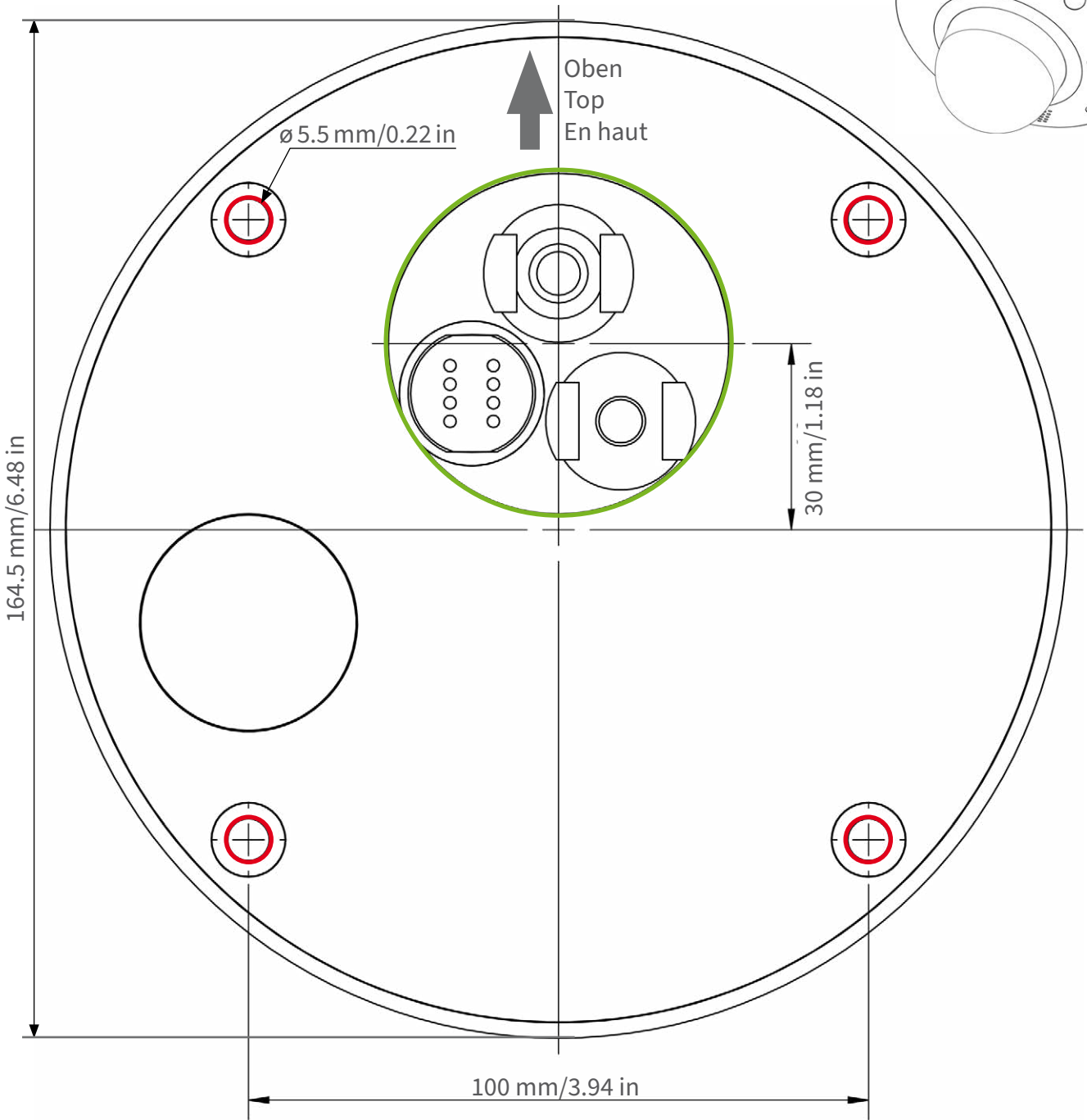
**CAUTION!** Always print or copy the drilling template at 100% of the original size!



 Ausschnitt für Kabel und Anschlüsse  
Cutout for cables and connectors  
Découpe pour les câbles et les connexions



**Nur in Originalgröße kopieren oder ausdrucken!**  
**Always copy or print at 100% of original size!**  
**Copier ou imprimer uniquement aux dimensions d'origine !**

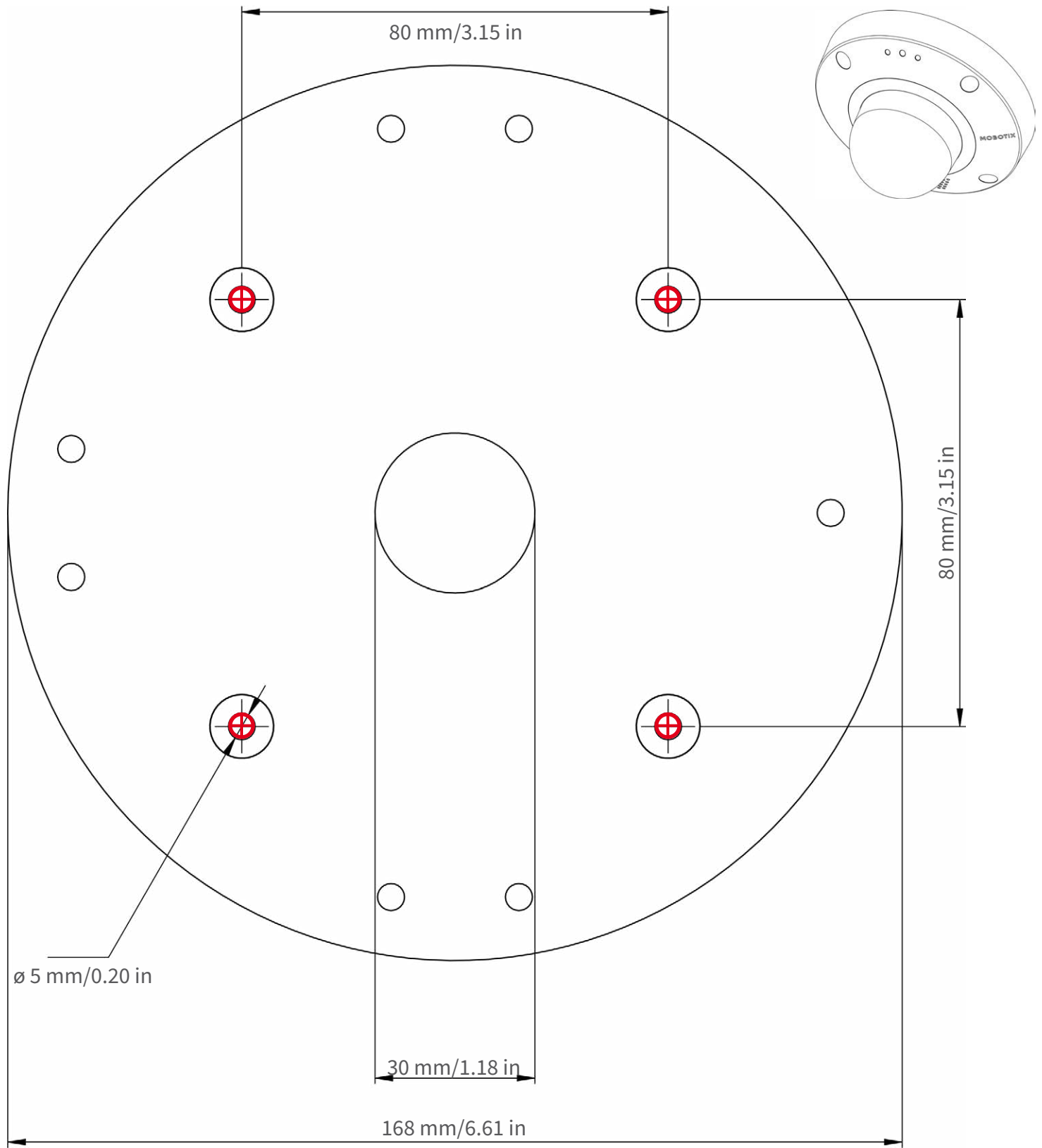



**Nur in Originalgröße kopieren oder ausdrucken!**  
**Always copy or print at 100% of original size!**  
**Copier ou imprimer uniquement aux dimensions d'origine !**

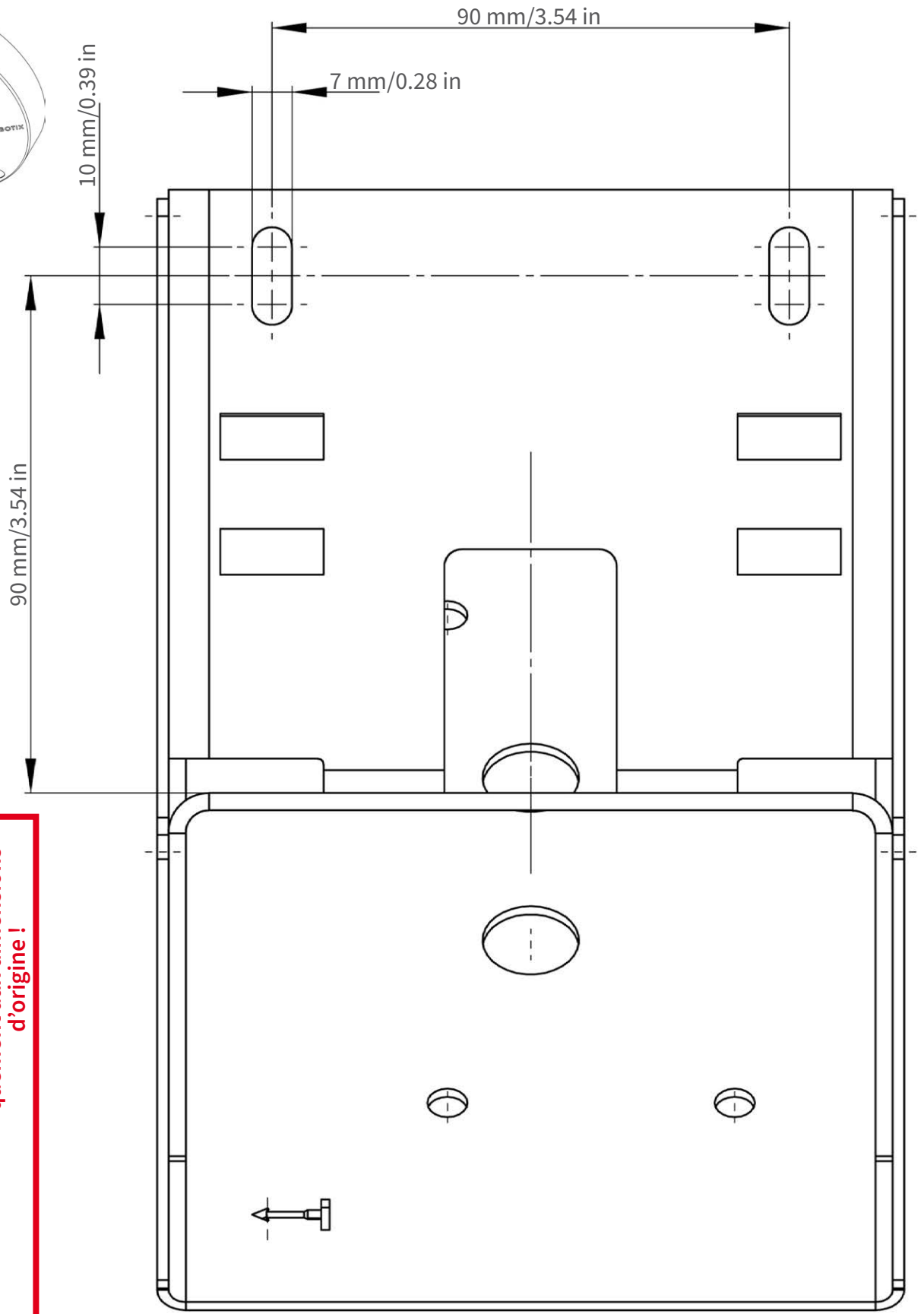
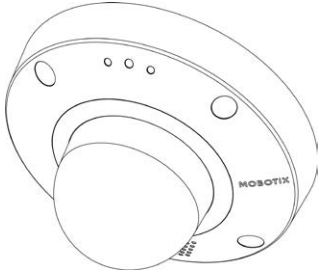

**Nur in Originalgröße kopieren oder ausdrucken!**  
**Always copy or print at 100% of original size!**  
**Copier ou imprimer uniquement aux dimensions d'origine !**





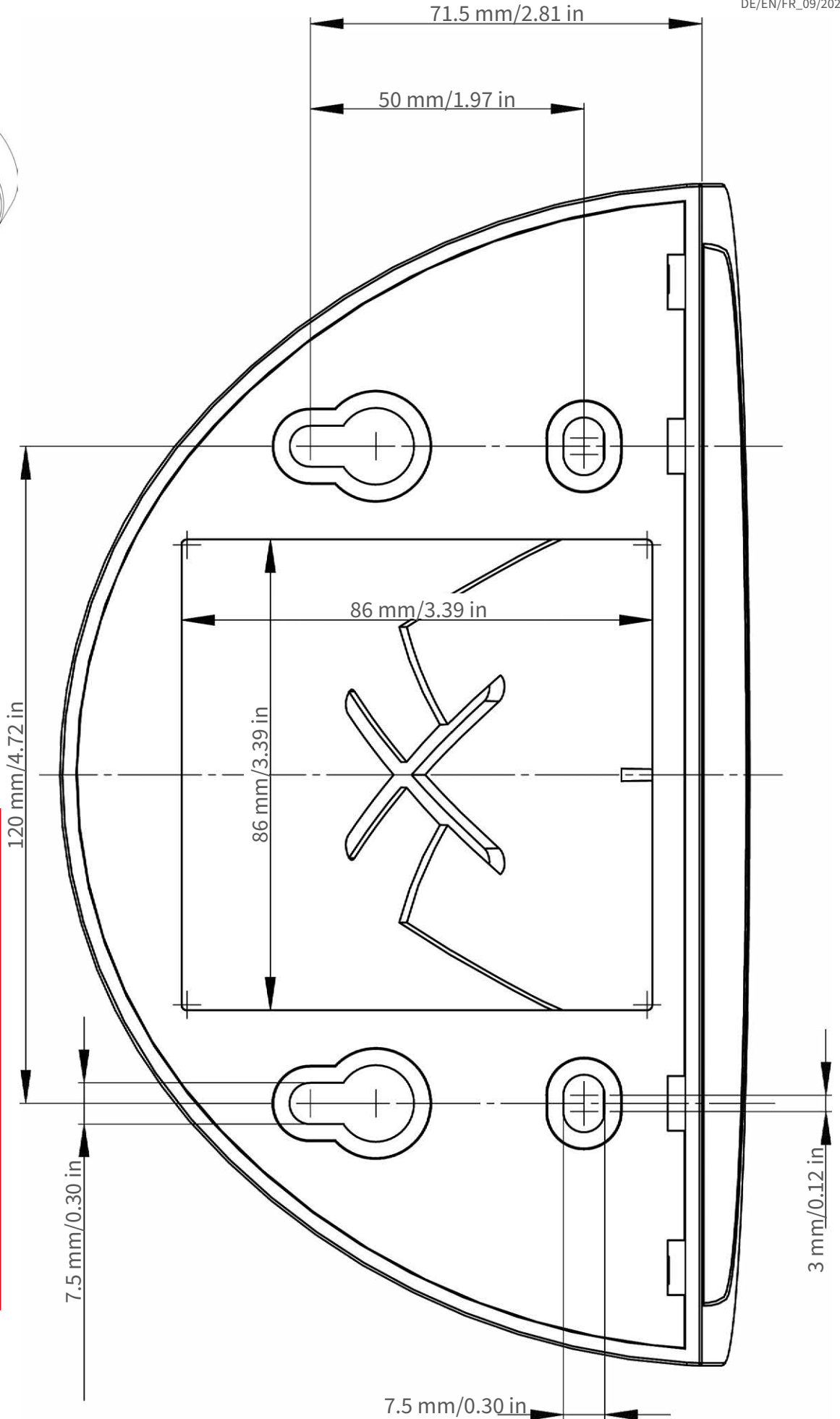
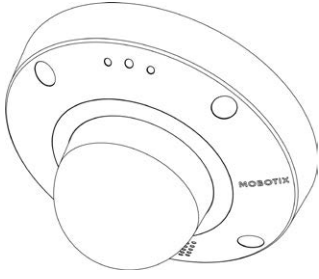

**Nur in Originalgröße kopieren oder ausdrucken!**  
**Always copy or print at 100% of original size!**  
**Copier ou imprimer uniquement aux dimensions d'origine !**

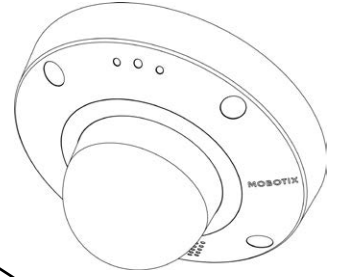

Ø 200 mm/7.87 in



**Nur in Originalgröße kopieren oder ausdrucken!**

**Always copy or print at 100% of original size!**

**Copier ou imprimer uniquement aux dimensions d'origine !**

## Scope of Delivery

This section contains the following information:

<b>MOBOTIX v71: Scope of Delivery</b> .....	<b>20</b>
<b>Mounting Supplies: Scope of Delivery</b> .....	<b>21</b>
<b>Wall Mount: Scope of Delivery</b> .....	<b>22</b>
<b>In-Ceiling Set: Scope of Delivery</b> .....	<b>23</b>

# MOBOTIX v71: Scope of Delivery



## Scope of delivery MOBOTIX v71 Body

Item	Count	Description
1.2	1	USB plug, blue (installed)
1.3	1	Bayonet catch for USB port, blue (installed)
1.4	1	Ethernet plug, blue (installed)
1.5	1	Bayonet catch for Ethernet port, blue (installed)
1.6	1	Ethernet patch cable RJ45, 50 cm/19.7 in
1.7	1	SD card cover (installed)
1.8	1	SD card 8 GB (installed)
1.9	1	Mounting supplies (see <a href="#">Mounting Supplies: Scope of Delivery, p. 21</a> )
1.10	1	Camera Connection Flyer
1.11	1	Important Safety Information
1.14	2	Anti-glare ring

# Mounting Supplies: Scope of Delivery

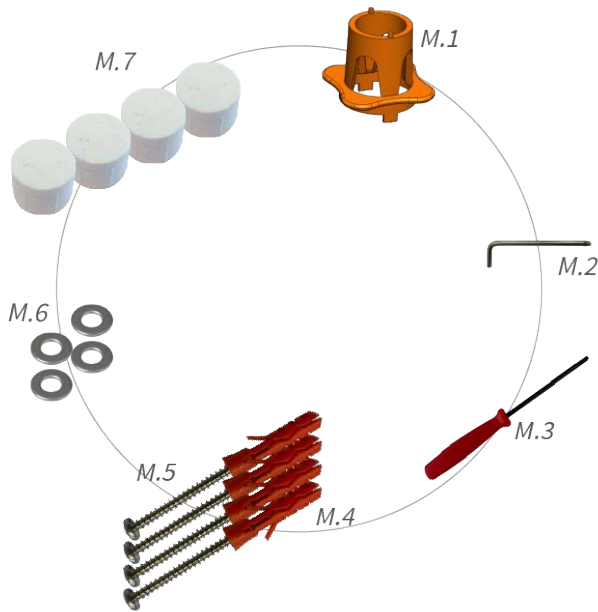

## Scope of Delivery v71 Mounting Supplies

Item	Count	Description
M.1	1	v71 lens wrench, orange
M.2	1	Torx wrench 3.5 mm
M.3	1	Allen wrench 2.5 mm
M.4	4	Dowels 8 mm
M.5	4	Stainless steel pan head-screws 4.5x60 mm
M.6	4	Stainless steel washers Ø5.3 mm
M.7	4	Sealing plugs, white

# Wall Mount: Scope of Delivery

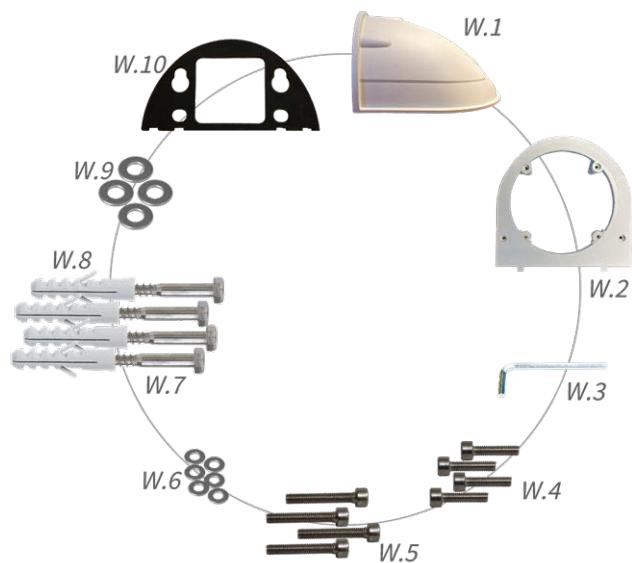

## Scope of Delivery Wall Mount

Item	Count	Description
W.1	1	Wall Mount upper shell, white
W.2	1	Bottom plate, white
W.3	1	Allen wrench 3 mm
W.4	2	Stainless steel Allen screws 4x18 mm
W.5	4	Stainless steel Allen screws 4x40 mm
W.6	6	Stainless steel washers Ø4.3 mm
W.7	4	Stainless steel hex head screws 6x50 mm
W.8	4	Dowels 8 mm
W.9	4	Stainless steel washers Ø6.3 mm
W.10	1	Adhesive wall sealing, black

# In-Ceiling Set: Scope of Delivery

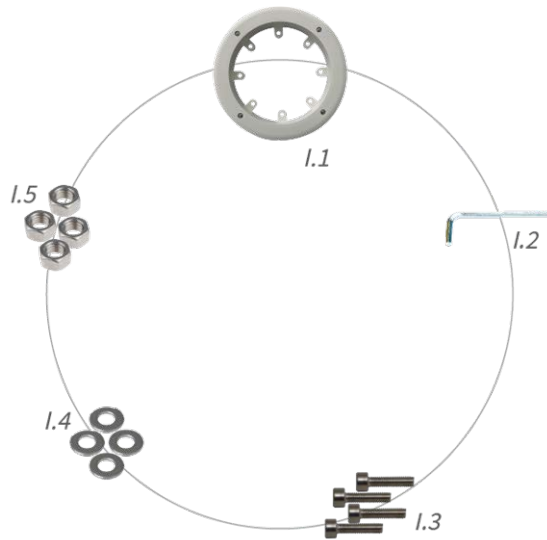

## Scope of Delivery In-Ceiling Set

Item	Count	Description
I.1	1	In-Ceiling Set
I.2	1	Allen wrench 5 mm
I.3	4	Stainless steel Allen screws M6x30 mm
I.4	4	Stainless steel washers M6
I.5	4	Stainless steel hexagon nut M6





## Technical Specifications

This section contains the following information:

<b>Order Information</b> .....	<b>26</b>
<b>Hardware</b> .....	<b>26</b>
<b>Image and Video Properties</b> .....	<b>27</b>
<b>General Software Features</b> .....	<b>28</b>
<b>Video Analysis</b> .....	<b>29</b>
<b>Video Management Software</b> .....	<b>29</b>
<b>Dimensions</b> .....	<b>30</b>

## Order Information

Name	MOBOTIX v71
Order Code:	Mx-v71A-8DNxxx/Mx-v71A-4DNxxx

## Hardware

Image sensor (DN)	4K UHD 3840x2160, 16:9, 1/1.8"
Light sensitivity	<ul style="list-style-type: none"> <li>▪ Color sensor (day): 0,1 lx @ 1/60 s; 0,005 lx @ 1 s</li> <li>▪ BW sensor (night): 0,02 lx @ 1/60 s; 0,001 lx @ 1 s</li> </ul>
Exposure control	Manual and automatic mode 1 s to 1/16,000 s
IP protection class	IP40
Operating temperature range	-10 to 50 °C/-14 to 122 °F
Internal DVR Storage	Internal microSD card (SDHC/SDXC), 8 GB out of the box, max. 1 TB.
Microphone/Speaker	Integrated Microphone: <ul style="list-style-type: none"> <li>▪ Sensitivity: -35 dB +/-4 dB (0 dB = 1 V/pa, 1 kHz)</li> </ul> Integrated Loudspeaker: <ul style="list-style-type: none"> <li>▪ 0.9 W at 8 Ohm</li> </ul>
Integrated illumination	850nm IR, up to 30 m/100 ft (may be more depending on scene)
Shock detector (tamper detection)	Yes
Max. power consumption	max. 25 W
Average power consumption	9.5 W
Electrical surge protection	Available with MX-Overvoltage-Protection-Box (not part of the scope of delivery)

PoE standard	PoE Plus (802.3at-2009)/Class 4 (Class 3 can be enabled via HW switch. <b>Note:</b> IR illumination requires Class 4)
Interfaces	<ul style="list-style-type: none"> <li>▪ Ethernet 1000BaseT (RJ45 according to EIA/TIA-568B)</li> <li>▪ USB-C/USB2.0; High-Speed (<math>V_{out} = 5.1\text{ V}</math>, <math>I_{out} = 0.9\text{ A}</math>, <math>P_{out} = 4.5\text{ W}</math>)</li> </ul>
Mounting Options	Wall- or ceiling-mountable
Dimensions (Ø x height)	164 x 96 mm
Weight	Gross weight: 1.050 g
Housing	Aluminum, PBT-30GF
Standard accessories	See <a href="#">MOBOTIX v71: Scope of Delivery, p. 20</a>
Detailed technical documentation	<a href="http://www.mobotix.com">www.mobotix.com</a> > <a href="#">Support</a> > <a href="#">Download Center</a> > <a href="#">Marketing &amp; Documentation</a>
MTBF	80,000 hours
Certificates	EN 50121-4, EN 55032, EN 55035, EN 61000-6-1, EN 61000-6-2, EN 61000-6-3, EN 61000-6-4, EN 62368-1, EN 63000, AS/NZS CISPR32, 47 CFR Part 15b
Protocols	DHCP (client and server), DNS, ICMP, IGMP v3, IPv4, IPv6, HTTP, HTTPS, FTP, FTPS, NFS, NTP (client and server), RTP, RTCP, RTSP, SFTP, SIP (client and server), SMB/CIFS, SNMP, SMTP, SSL/TLS 1.3, TCP, UDP, VLAN, VPN, Zero-conf/mDNS
Manufacturer warranty	5 years

## Image and Video Properties

Available video codecs	<ul style="list-style-type: none"> <li>▪ H.264, H.265</li> <li>▪ MxPEG+</li> <li>▪ MJPEG</li> </ul>
Image resolutions	VGA 640x360, XGA 1024x576, HD 1280x720, FullHD 1920x1080, QHD 2560x1440, 4K UHD 3840x2160
Multi streaming	H.264, H.265 with triple streaming
Multicast stream via RTSP	Yes

## Technical Specifications

### General Software Features

---

Max. image resolution	4K UHD 3840x2160/4MP 2688x1512
Max. frame rate (fps)	MxPEG: 20@4k, H.264: 30@4k, H.265: 30@4k

---

## General Software Features

Feature	Properties
WDR	Up to 120 dB
Software features	<ul style="list-style-type: none"><li>▪ H.264, H.265 Multistreaming</li><li>▪ Multicast stream via RTSP</li><li>▪ Digital pan, tilt, zoom/vPTZ (up to 8x zoom)</li><li>▪ Genetec protocol integration</li><li>▪ Programmable exposure zones</li><li>▪ Snapshot recording (pre/post-alarm images)</li><li>▪ Continuous recording</li><li>▪ Event recording</li><li>▪ Time-controlled flexible event logic</li><li>▪ Weekly schedules for recordings and actions</li><li>▪ Event video and image transfer via FTP and email</li><li>▪ Playback and QuadView via web browser</li><li>▪ Animated logos on the image</li><li>▪ Master/Slave functionality</li><li>▪ Privacy zone scheduling</li><li>▪ Remote alarm notification (network message)</li><li>▪ Programming interface (HTTP-API)</li><li>▪ MxMessageSystem</li></ul>
ONVIF compatibility	Profile G, S, T, (M with later firmware release)
Master/Slave functionality	Yes
Remote alarm notification	email, network message (HTTP/HTTPS), SNMP, MxMessageSystem, MQTT

Feature	Properties
DVR/image storage management	<ul style="list-style-type: none"> <li>▪ On internal microSD card</li> <li>▪ On external USB and NAS devices</li> <li>▪ Different streams for live image and recording</li> <li>▪ MxPEG+ only</li> <li>▪ MxFFS with buffered archive, pre- and post-alarm images, storage monitoring with error reporting</li> </ul>
Camera and data security	User and group management, SSL connections, IP-based access control, IEEE 802.1X, intrusion detection, digital image signature
Digitally signed firmware	Yes (to prevent firmware file tampering)

## Video Analysis

Feature	Properties
Video motion detection	Yes
MxActivitySensor	Version 1.0, 2.1, 3.0 and object-based MxAnalytics AI
MxAnalytics	Yes with a later FW release
MOBOTIX App support	Yes with a later FW release

## Video Management Software

Feature	Properties
MOBOTIX HUB	Yes <a href="http://www.mobotix.com">www.mobotix.com</a> > Support > Download Center > Software Downloads
MxManagementCenter	Yes (latest version recommended) <a href="http://www.mobotix.com">www.mobotix.com</a> > Support > Download Center > Software Downloads
MOBOTIX Cloud	Streaming & Events supported
MOBOTIX LIVE App	Yes (available in Google Play Store (Android) and Apple App Store (iOS)).
3rd Party VMS Software	see ONVIF Profile S, T and G specification

# Dimensions

**NOTE!** Download the drilling template from the MOBOTIX website: [www.mobotix.com](http://www.mobotix.com) > [Support](#) > [Download Center](#) > [Marketing & Documentation](#) > [Drilling Templates](#).

**CAUTION!** Always print or copy the drilling template at 100% of the original size!

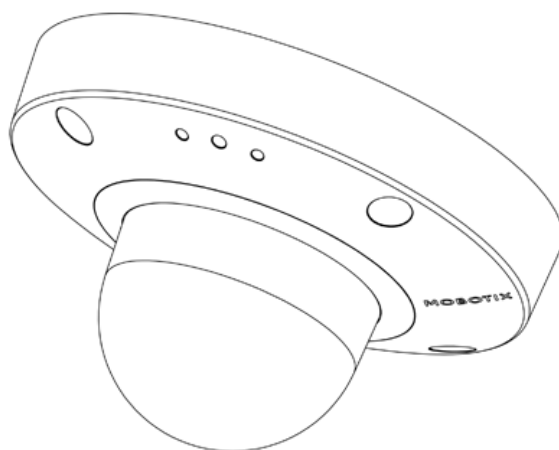
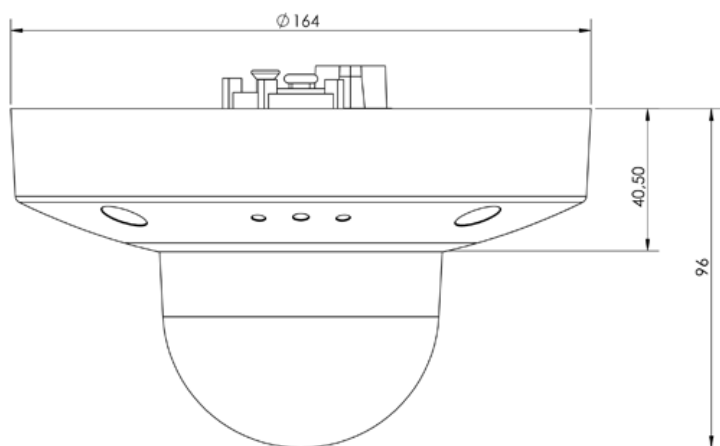

# In-Ceiling Set D7x\_Q7x

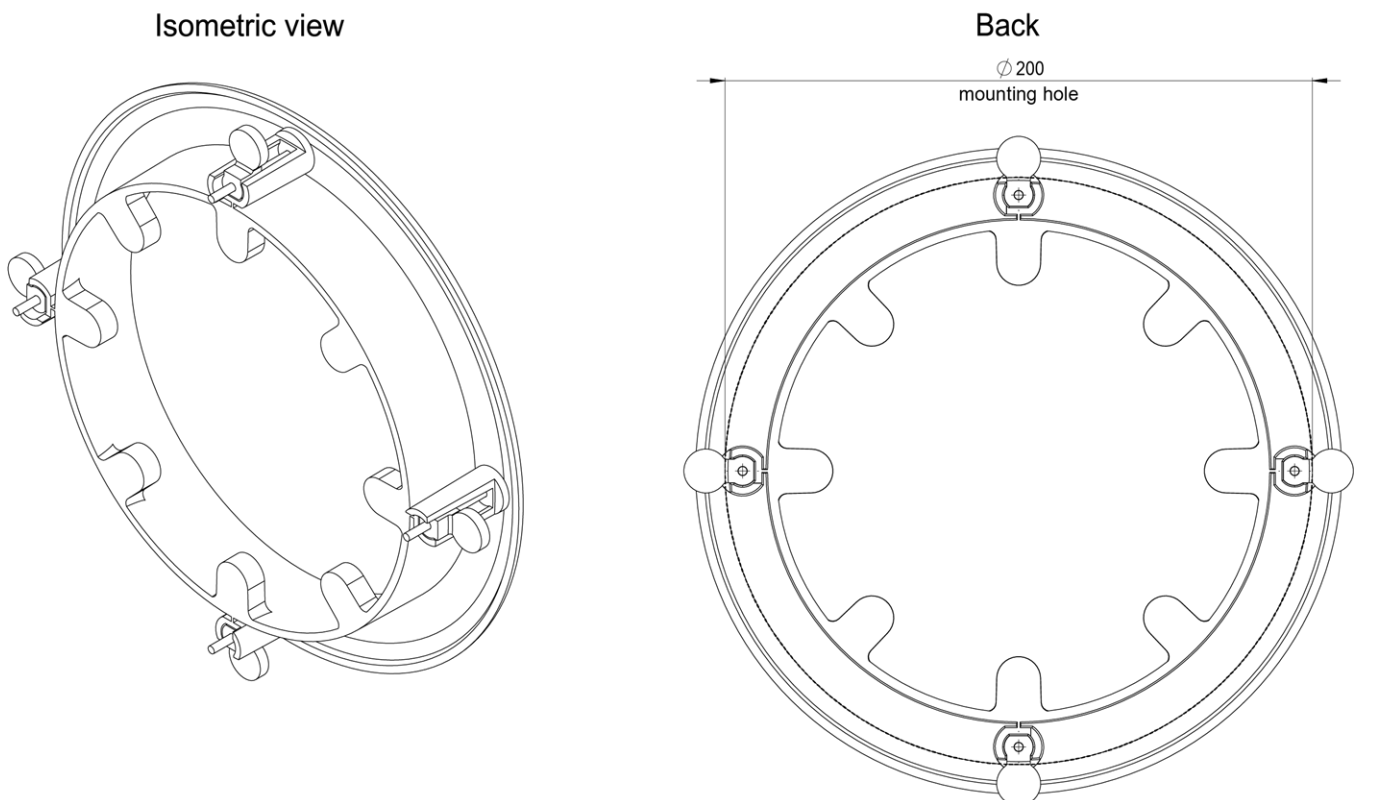
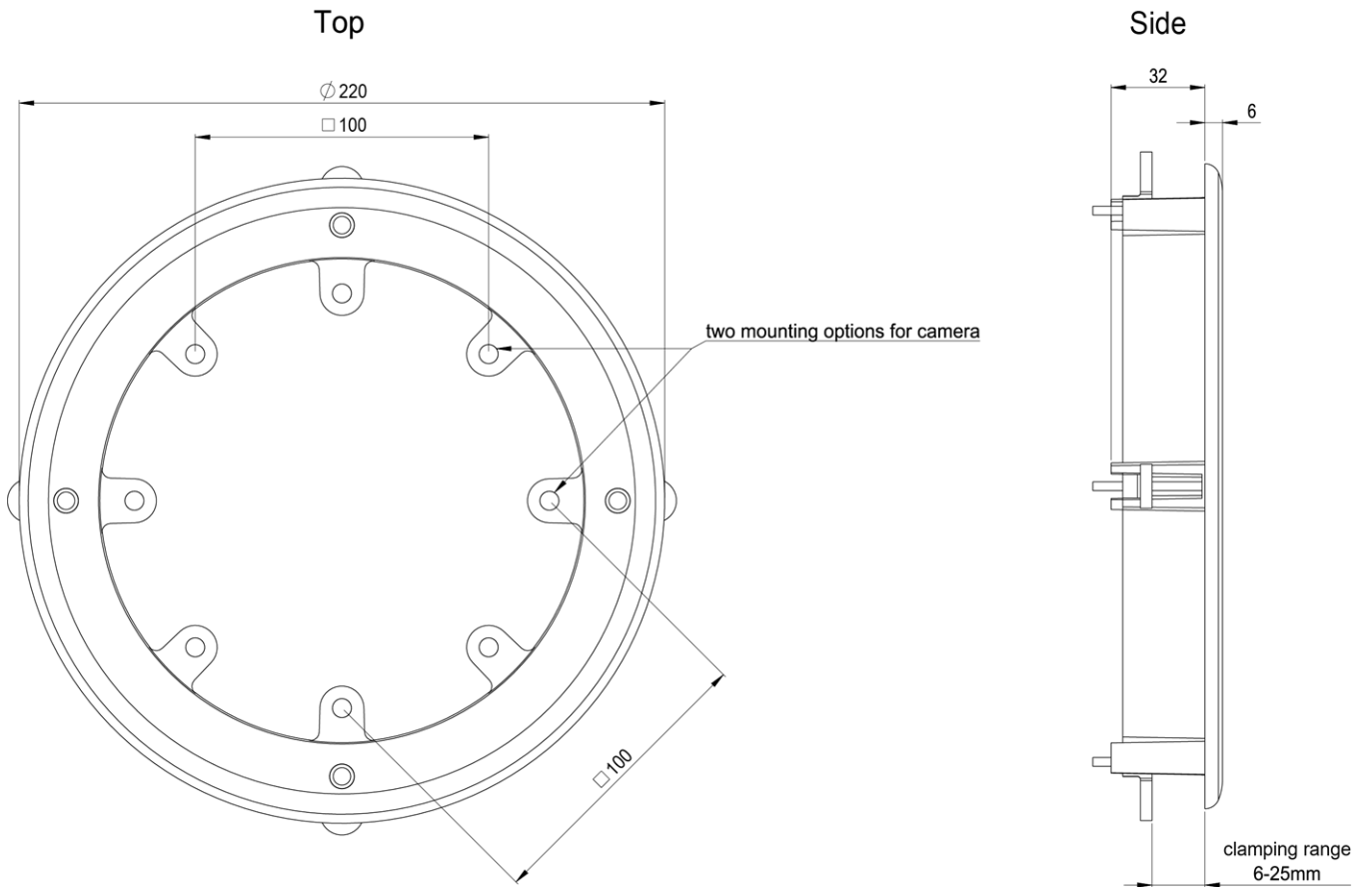





## Mounting

This section contains the following information:

<b>Adjusting the Camera Lens</b> .....	<b>34</b>
<b>Mounting Options</b> .....	<b>38</b>
<b>Connecting the Camera</b> .....	<b>52</b>

## Adjusting the Camera Lens

Adjusting the camera at the mounting position will ensure that you will see the desired field of view later on.

**CAUTION!** When adjusting the image focus or the field of view of the camera, always make sure that you can see the live image of the camera on your monitor. See [Camera Software in the Browser, p. 65](#).

## Removing the Dome

1. Remove the cover of the clamping ring ① by turning counterclockwise until resistance is felt.



2. Loosen the four fastening screws from the clamping ring with the supplied Allen wrench [M.3, p. 21](#) and then carefully pull off the dome.



3. Pull the dome off upwards.

## Focusing the Camera Lens

1. Release the two allen screws ① on both sides of the lens mount with the supplied Allen wrench [M.3, p. 21](#). Focus the lens ⑤ by turning the lens with the lens wrench, [M.1, p. 21](#). Focus the lens ⑤ by turning the lens with the lens wrench, [M.1, p. 21](#).



2. Aim the camera by rotating ② and panning ③ the lens mount.



**CAUTION!** Never use force when adjusting the direction of the camera, as this could damage the camera beyond repair.

3. Fasten the two allen screws ① on both sides of the lens mount.

## Mounting

### Adjusting the Camera Lens

---

4. Release the screw ④ on top of the lens mount for aiming the lens.



5. Aim the lens ⑤ by turning the lens with the lens wrench, [M.1, p. 21](#).



**CAUTION!** Do not turn the objective more than the noticeable stop.  
Overturning may damage the sensor board on which the lens is mounted.

6. Tighten the screw ④ on top of the lens mount.

**NOTE!** The lens can only be focused when the screw on the top of the lens mount is tightened.

7. Focus the lens ⑤ by turning the lens with the orange lens wrench [M.1, p. 21](#).

**NOTE!** After focusing, further adjustment of the focusing must be made due to the optical properties of the dome.

This table shows the approximate rotations required to optimally adjust the objective to the mounted dome.

Lens	Turns (counterclockwise)	Degrees (counterclockwise)
95°/5 mm	~ 0	~ 0°
60°/8 mm	~ 1/16	~ 22,5°
45°/10 mm	~ 1/8	~ 45°
30°/15 mm	~ 1/4	~ 90°
15°/28 mm	~ 1	~ 360°

8. If required, clean the optical surfaces using a clean, lint-free cotton cloth.
9. If not already in place attach the anti-glare ring to the lens (see [Attaching the Anti Glare Ring, p. 37](#)).
10. Reinsert the dome and the clamping ring, then fasten the four fastening screws with the supplied Allen wrench [M.3, p. 21](#).

## Attaching the Anti Glare Ring

The anti-glare ring is used to protect the lens from glare effects that can have a negative effect on the camera image.

**CAUTION!** The anti-glare ring is not mounted when delivered and should be installed before operating the device.

1. Remove the dome (see [Removing the Dome, p. 34](#))
2. Remove the protective film from the adhesive surface of the anti-glare ring [1.14, p. 20](#).
3. Carefully press the anti-glare ring ① with the adhesive surface into the recess around the lens.



## Attaching the dome

1. Insert the dome and the clamping ring, then fasten the four fastening screws with the supplied Allen wrench [M.3, p. 21](#).



2. Attach the cover of the clamping ring ① by turning clockwise until resistance is felt.



**CAUTION!** Never use force when adjusting the direction of the camera, as this could damage the camera beyond repair.

## Mounting Options

You can mount the MOBOTIX v71 to any even surfaces e.g. on ceilings or walls without any accessories.

**CAUTION!** The MOBOTIX v71 camera must be mounted on the ceiling. Only in this way is reliable observation of the nursing beds possible.

### Accessories for Mounting

- The Wall Mount provides the ideal mounting option for installations where the camera is supposed to point downwards.
- Using the Wall Mount and the stainless steel Corner/Pole Mount, the camera can also be mounted to poles with up to 180 mm/7.1" diameter or to 90° corners.

- With the In-Ceiling Set, you can discreetly install the MOBOTIX v71 Camera in the ceiling with the connections and most components hidden inside the ceiling.

All mounting options provide concealed cabling, thus improving installation security.

**CAUTION!** Installation only on flat surface! Unevenness must not exceed 0.5 mm/0.02 in!  
Only use genuine MOBOTIX patch cables to guarantee the weatherproofness!

**NOTE!** Before mounting the camera, determine its ideal position and make sure that the field of view is not obstructed in any way. Once the camera has been mounted, you can fine-tune the image.

## Mounting the Camera Without Accessories

The MOBOTIX v71 can be easily installed directly on walls or ceilings. For installation without any accessories, you should first install a flush-mounted wall outlet, since the connectors on the rear of the camera need some space.

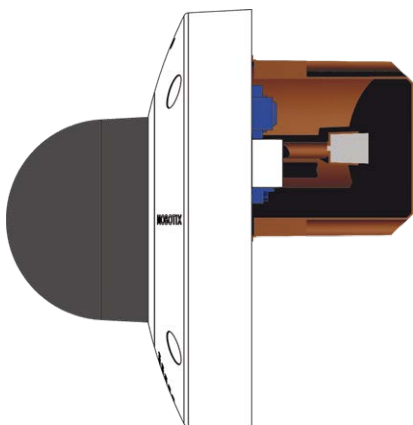

Before mounting the camera, make sure that a network connection with power supply according to the PoE Plus (802.3at-2009) standard is available at the mounting position (see [Connecting the Camera, p. 1](#)).

**NOTE!** Do not use the dowels if the installation surface is wood. Only use the screws to fasten the mounting plate directly on the surface. In order to facilitate screwing in wood, the positions should first be pre-drilled using a 2 mm drill bit, for example (drilling depth just slightly less than screw length).

## Step by Step

1. Mark the holes ① for drilling using the drilling template (see [Drilling Template as PDF](#)). When drilling, use a suitable 8 mm drill bit and drill holes at least 60 mm/1.2 deep.

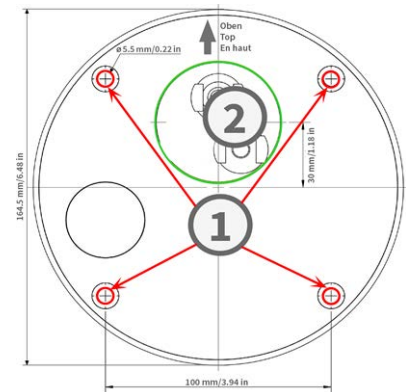

**NOTE!** The drilling template also includes a circle ② marking the minimum size and position of the wall outlet, in addition to the drilling holes.

2. Fully push the dowels [M.4, p. 21](#) into the holes you drilled.
3. Establish the PoE network connection to the camera (see [Connecting the Camera to the Network, p. 53](#)).
4. Mount the camera using the supplied pan head screws [M.5, p. 21](#).

## Mounting with the On-Wall Set





**CAUTION!** Before mounting the camera, make sure that a network connection with power supply according to the PoE Plus (802.3at-2009) standard is available at the mounting position (see [Connecting the Camera to the Network](#)).

The On-Wall Set available in 0° and 10° inclinations allows you to easily mount the MOBOTIX v71 on the wall or ceiling. The camera remains IP65 weatherproof (dust-proof and resistant to water jets). The On-Wall Sets also cover RJ45 wall outlets and has ample space for additional modules ([Installing a Mini-Box in the On-Wall Set](#), p. 43, WiFi, batteries, etc.).

The 10° On-Wall Set is the right choice if you want to mount the MOBOTIX v71 on a wall with the lens pointing vertically downward (90° or more).

**NOTE!** If the 10° On-Wall Set is not used, then the angle of the lens may not exceed 80° for design-related reasons.

**NOTE!** Download the drilling template from the MOBOTIX website: [www.mobotix.com](http://www.mobotix.com) > [Support](#) > [Download Center](#) > [Marketing & Documentation](#) > [Drilling Templates](#).

**CAUTION!** Always print or copy the drilling template at 100% of the original size!

**NOTE!** Do not use the dowels if the installation surface is wood. Only use the screws to fasten the mounting plate directly on the surface. In order to facilitate screwing in wood, the positions should first be pre-drilled using a 2 mm drill bit, for example (drilling depth just slightly less than screw length).

## Step by Step

1. Mark the holes for drilling using the drilling template (see [Drilling Template](#), p. 13). When drilling, use a suitable 8 mm drill bit and drill holes with at least 60 mm/1.2" depth.
2. Fully push the dowels [W.8](#), p. 22 into the holes ① you drilled.

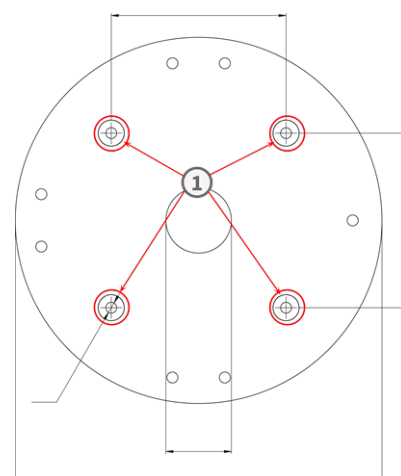

## Mounting

### Mounting Options

---

3. If you use the 0° set, close the cable openings ② that are not needed with the enclosed closing plugs. Fix each of them in place from the inside using a small hexagonal nut.



4. Fit the cable gland ③ to the cable opening of the On-Wall Set such that the black rubber seal is on the outside. Fix it in place from the inside using a small hexagonal nut.

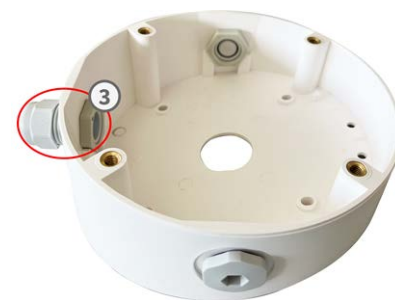

5. Mount the On-Wall Set (without the camera) at the intended position using the Torx screws from the accessories ④ .



6. Attach the counter nut ⑤ to the network cable, pass it through the seal from the outside and tighten the nut. The network cable is now screwed into the On-Wall Set, weatherproof.

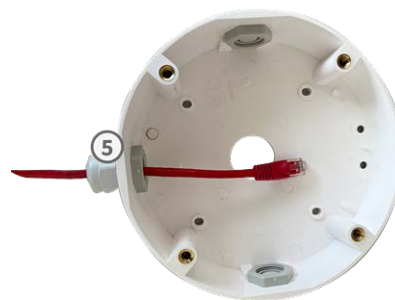

7. Connect the on-site network cable with the camera patch cable using a standard connector. Excess cable can be stored easily within the On-Wall Set (see [Connecting the Camera, p. 52](#)).

8. Remove the rubber plugs from the front of the camera.



9. Using the supplied Allen wrench [W.2, p. 22](#), secure the camera to the bottom plate of the On-Wall Set with four Allen screws [W.5, p. 22](#) and one washer [W.6, p. 22](#) each.

10. Push the rubber plugs [M.7, p. 21](#) into the screw holes of the camera.

11. Connect the camera to the PoE network connection of the building (see [Connecting the Camera to the Network, p. 53](#)).

## Installing a Mini-Box in the On-Wall Set



MOBOTIX offers various interface boxes that can be easily installed in the housing of the On-Wall Set. The following interface boxes are compatible with your camera:

- Overvoltage-Protection-Box LSA  
Network connector with overvoltage protection, LSA version

## Mounting

### Mounting Options

---

- Overvoltage-Protection-Box RJ45  
Network connector with overvoltage protection, RJ45 version
- NPA-Box  
Weatherproof PoE injector (IEEE 802.3af) and network connector

Two double-sided adhesive pads are included in the scope of delivery of a mini box.



## Step by Step

1. Stick the adhesive pads to the bottom of the mini box as shown in the image.

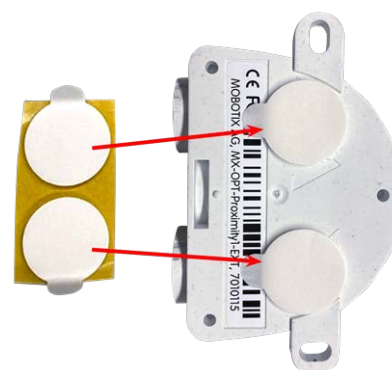

2. Remove the protective foil from the adhesive pads, place the two tabs of the mini box with light pressure on the plastic lugs of the on-wall set.

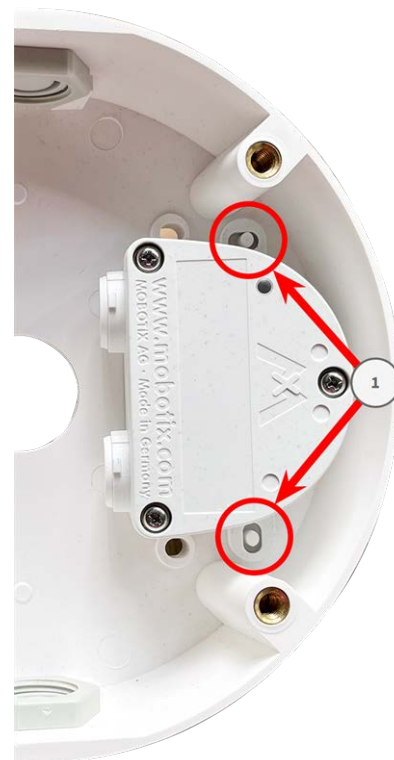

## Mounting with the In-Ceiling Set



## Mounting

### Mounting Options

---

**CAUTION!** Before mounting the camera, make sure that a network connection with power supply according to the PoE Plus (802.3at-2009) standard is available at the mounting position (see [Connecting the Camera to the Network](#)).

With the In-Ceiling Set, you can discreetly install the MOBOTIX v71 Camera in the ceiling with the connections and most components hidden inside the ceiling. The In-Ceiling Set is particularly suitable if the v71 is to be installed in suspended ceilings of indoor spaces with customer or public traffic (e.g. hotels, restaurants, banks, retail stores, public buildings, etc.).

**NOTE!** Download the drilling template from the MOBOTIX website: [www.mobotix.com](http://www.mobotix.com) > [Support](#) > [Download Center](#) > [Marketing & Documentation](#) > [Drilling Templates](#).

**CAUTION!** Always print or copy the drilling template at 100% of the original size!

## Step by Step

1. Cut a round hole with a diameter of 200 mm into the ceiling (see [Drilling Template, p. 13](#)).

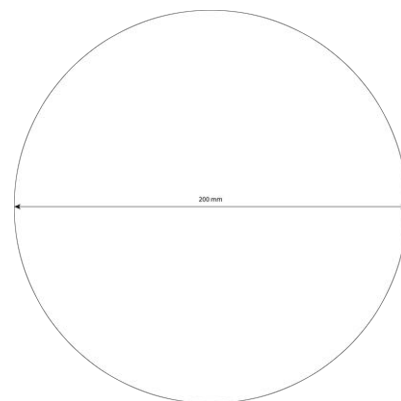

2. Run the network cable above the suspended ceiling and ensure that enough cable slack is available.
3. Remove the rubber plugs from the front of the camera.



4. Connect the on-site network cable with the camera patch cable using a standard connector. Excess cable can be stored easily within the In-Ceiling Set (see [Connecting the Camera, p. 52](#)).

5. Place the In-Ceiling Set in the ceiling opening and tighten the dovetail guides clockwise using a Phillips screwdriver.
6. Push the rubber plugs [M.7, p. 21](#) into the screw holes of the camera.



7. Connect the camera to the PoE network connection of the building (see [Connecting the Camera to the Network, p. 53](#)).

## Mounting with the Wall Mount

**CAUTION!** Before mounting the camera, make sure that a network connection with power supply according to the PoE Plus (802.3at-2009) standard is available at the mounting position (see [Connecting the Camera to the Network](#)).

The Wall Mount allows you to easily mount the MOBOTIX v71 to walls or extensions, indoors and outdoors. The camera remains IP65 weatherproof (dust-proof and resistant to water jets). The Wall Mount also covers RJ45 wall outlets and has ample space for additional modules (WiFi, batteries, etc.).

Before mounting the MOBOTIX v71 with the Wall Mount, drill the holes for the fixtures. You can use the supplied drilling template (see [Drilling Template as PDF](#)).

**NOTE!** Download the drilling template from the MOBOTIX website: [www.mobotix.com](http://www.mobotix.com) > [Support](#) > [Download Center](#) > [Marketing & Documentation](#) > [Drilling Templates](#).

**CAUTION!** Always print or copy the drilling template at 100% of the original size!

**NOTE!** Do not use the dowels if the installation surface is wood. Only use the screws to fasten the mounting plate directly on the surface. In order to facilitate screwing in wood, the positions should first be pre-drilled using a 2 mm drill bit, for example (drilling depth just slightly less than screw length).



## Step by Step

1. Mark the holes ① for drilling using the drilling template (see [Drilling Template, p. 13](#)). When drilling, use a suitable 8 mm drill bit and drill holes with at least 60 mm/1.2" depth.

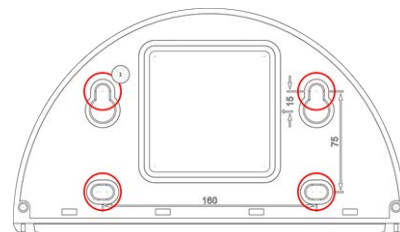

2. Fully push the dowels [W.8, p. 22](#) into the holes you drilled.
3. Remove the protective foil from the black wall sealing [W.10, p. 22](#) and apply it to the back of the Wall Mount (the surface must be clean and free of grease).
4. Pass the network cable through the large square opening into the Wall Mount.



5. Use the supplied hex head screws [W.7, p. 22](#) to install the Wall Mount at the intended position.
6. Remove the rubber plugs from the front of the camera.



7. Prepare the on-site network cable for connection with the camera patch cable using a standard connector. Excess cable can be stored easily within the Wall Mount (see [Connecting the Camera, p. 52](#)).
8. Using the supplied Allen wrench [W.2, p. 22](#), secure the camera to the bottom plate of the Wall Mount with two long Allen screws [W.5, p. 22](#) and one washer [W.6, p. 22](#) each.





9. Connect the camera to the PoE network connection of the building (see [Connecting the Camera to the Network](#), p. 53).
10. Install the bottom plate [W.2](#), p. 22 with the camera in the Wall Mount:



Use two short allen screws [W.4](#), p. 22 with one washer [W.6](#), p. 22 each to secure the camera on the rear side of the bottom plate ① .

- Use two long allen screws [W.5](#), p. 22 with one washer [W.6](#), p. 22 each to secure the camera on the front side of the bottom plate ② .

11. Push the rubber plugs [M.7](#), p. 21 into the screw holes of the camera ( ① and ② in the figure above).

## Mounting on a Corner (Corner/Pole Mount)

**CAUTION!** Before mounting the camera, make sure that a network connection with power supply according to the PoE Plus (802.3at-2009) standard is available at the mounting position (see [Connecting the Camera to the Network](#)).

### Dimensions MOBOTIX v71 Corner/Pole Mount

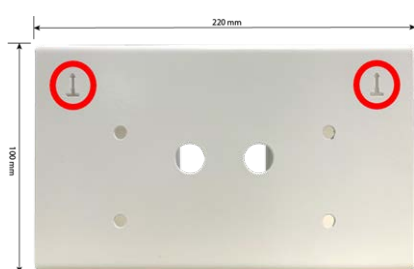

**NOTE!** When installing, the arrows of the mount must point upwards.

## Mounting

### Mounting Options



### Step by Step

1. Mark the four screw anchor holes ① on the corner of the building using the drilling template. Make sure that the arrows ② on the Corner/Pole Mount point upwards.

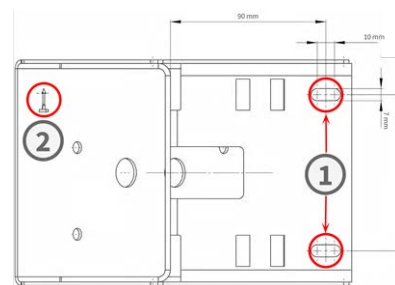

2. Drill the holes with a 10 mm wall drill then place the included dowels in the drilled holes.

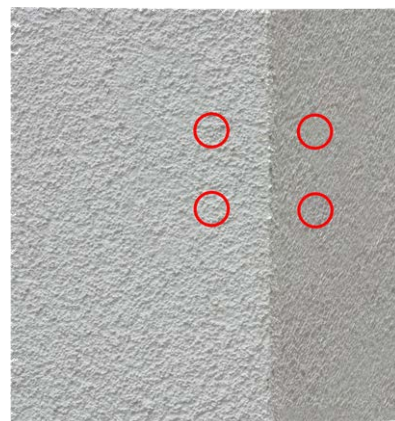

3. Push the supplied network cable through one of the holes ①.

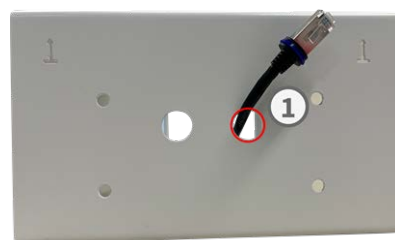

4. Screw the Corner/Pole Mount into place on the corner of the building using the wood screws and washers.
5. Proceed by mounting the Wall Mount to the Corner/Pole Mount as described in [Mounting with the Wall Mount, p. 47](#).



## Mounting on a Pole (Corner/Pole Mount)

**CAUTION!** Before mounting the camera, make sure that a network connection with power supply according to the PoE Plus (802.3at-2009) standard is available at the mounting position (see [Connecting the Camera to the Network](#)).

**NOTE!** The pole should have a diameter between 60 and 180 mm.

For dimensions of the Corner/Pole Mount, please refer to [Dimensions MOBOTIX v71 Corner/Pole Mount, p. 49](#).

### Step by Step

1. Guide the supplied stainless steel straps along the cutouts in the Corner/Pole Mount as shown in the figure.
2. Prepare the pole mount with steel straps
3. Tighten the stainless steel straps on the Corner/Pole Mount with a screwdriver. If necessary, the ends of the straps can be cut off.



## Mounting

### Connecting the Camera

---

4. Push the supplied network cable through one of the holes ① .

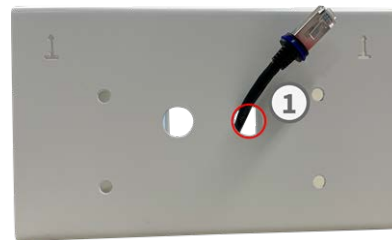

5. Prepare the network cabling
6. Proceed by mounting the Wall Mount to the Corner/Pole Mount as described in [Mounting with the Wall Mount, p. 47.](#)

## Connecting the Camera

All connections to the camera (network, MiniUSB, inputs/outputs) can be made directly on the camera. No further accessories are required for this. A PoE switch provides the camera's power supply.

### Connecting a USB-C Device

The camera has a USB-C port that allows connecting external storage media or extension boxes, for example.

1. To uncover the USB-C port, remove the bayonet catch by rotating it counter-clockwise, then remove the blue rubber plug.



2. Plug the USB-C connector into the port and press in firmly until the blue sealing ring clicks into place.



3. Attach the bayonet catch and turn it clockwise until it clicks in the locked position.
4. Connect the USB-C device to the other end of the USB cable.

## Connecting the Camera to the Network

### CAUTION!

- The PoE switch must provide Class 4 according to PoE Plus (802.3at-2009) as well as the 100/1000 Mbps Ethernet interface of the camera.
- It is highly recommended to use an uninterruptible power supply (UPS) for the switch.
- The maximum length of the network cable for remotely supplying power is 100 m (300 ft).



### Connecting the camera to the network

1. To uncover the RJ45 network connector, remove the bayonet catch ① by rotating it counter-clockwise and pull it off with the blue rubber plug.



## Mounting

### Connecting the Camera

---

2. Plug the supplied patch cable ② into the network connector and press the plug in firmly until the blue sealing ring clicks into place.

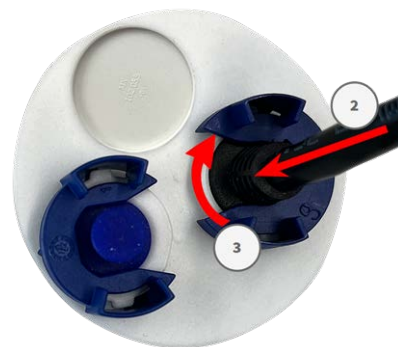

3. Attach the bayonet catch ③ by rotating it clockwise.
4. Connect the supplied patch cable 1.6, p. 20 with the PoE network connection of the building using a standard connector.

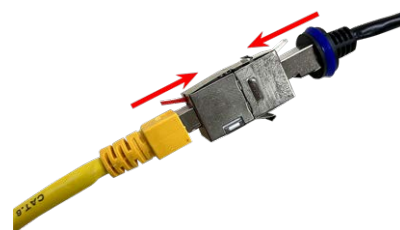

## Operating the Camera

This section contains the following information:

<b>Getting Started</b> .....	<b>56</b>
<b>Boot Options of the Camera</b> .....	<b>56</b>
<b>Network Settings</b> .....	<b>59</b>

# Getting Started

You can use the MOBOTIX v71 with any current browser – or with MxManagementCenter.

You can download MxManagementCenter free-of-charge from [www.mobotix.com](http://www.mobotix.com) > [Support](#) > [Download Center](#) > [Software Downloads](#).

- 1. Connect the camera to the network.** The network cable will also provide power to the camera(see [Connecting the Camera to the Network](#), p. 53).
  - 1. Establish a connection to the camera and adjust the network settings if required:** By factory default, MOBOTIX cameras are booting as DHCP client with an additional fixed IP address in the 10.x.x.x range (e.g., 10.16.0.128). Local computer networks usually have IP addresses in the 172 or 192 ranges. Depending on whether a DHCP server is present on the local network or if the network has been set up to use fixed IP addresses, there are several possibilities for establishing a connection to the camera and to change its [Network Settings](#), p. 59:
    - **Network with dynamic IP addresses**

**Using a browser:** If you know the IP address that the DHCP server assigned to the camera, simply enter that address in the browser address bar to directly connect to the camera

**Using MxManagementCenter:** With MxManagementCenter, you can show and integrate the camera without having to know its current IP address.
    - **Network with static IP addresses**

In order to access the camera, it must have an IP address within the range of the local network. To set the camera's network parameters, you can use one of these methods:

**Manually using a web browser:** You may have to adjust the network settings of your computer.
    - **Automatically using MxManagementCenter:** The camera is displayed in MxManagementCenter although the IP address is not part of the local network, allowing you to reconfigure its settings.
  - 2. Configure camera:** You can use the user interface of the camera in a browser or in MxManagementCenter.

## Boot Options of the Camera

By default, the camera starts as DHCP client and automatically tries to get an IP address from a DHCP server. To start the camera in a mode different from the default mode, you can activate the boot menu of the camera.



**NOTE!** Pressing the key of the camera will let the camera announce the current IP address of the camera on the speaker (if a speaker is attached to the camera).

**CAUTION!** When opening the camera, do not insert any objects into the housing. This could damage the camera!

## Prepare the camera

1. Disconnect the camera's power supply.
2. Remove the black cover screw ① with a screwdriver.

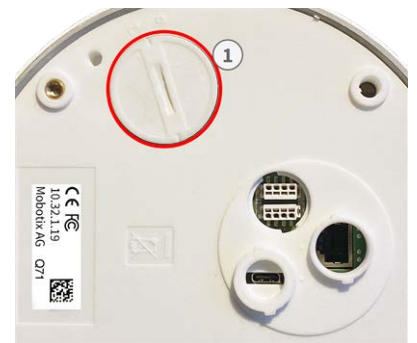

## Using the boot menu

After establishing the power supply the red LED on top of the camera body lights up 5 to 10 seconds and will stay on for 10 seconds.

1. Take a suitable tool for operating the boot menu (e.g. the tweezers [M.3](#)).
2. Reconnect the power supply of the camera.
3. With the tool press the small black reset button ② next to the SD card slot. The camera enters the boot menu, ready for selecting one of the boot options. The LED will flash once. The flash signal will be repeated every second.

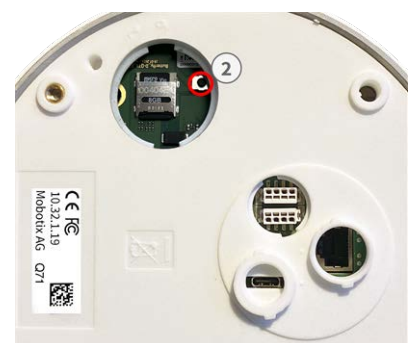

**NOTE!** The number of flashes corresponds to the current boot option.

4. **Switch the boot option:** Press the key (< 1 sec). After the last boot option, the camera returns to the first boot option (LED flashes once).

LED flashes	Boot Option	Meaning	Audio Confirmation*
1x	•/•	This option is not supported on this camera model.	•/•
2x	Factory Defaults	Starts the camera with factory defaults (factory default IP address, users and passwords will not be reset).	<b>Boing</b>
3x	Automatic IP Address	Starts the camera as DHCP client and tries to obtain an IP address from a DHCP server. If a DHCP server cannot be found or no IP address can be obtained, the camera starts with its factory default address.	<b>Boing-Boing</b>
4x	Recovery System	Starts the camera with the recovery system, e.g., in order to recover from a failed update of the camera software.	<b>Alarm Sound</b>

\*Only on cameras with audio option and installed speaker.

5. **Select a boot option:** Press the key longer (> 2 sec). The camera confirms the selection by flashing the LED rapidly for 3 seconds. After 20 sec, the camera will play a sound according to the table above.

**NOTE!** If you do not select a boot option, the camera will resume its normal boot process after a certain time.

**NOTE!**

Starting the Camera With Factory Defaults or an Automatic IP Address (DHCP)

The configurations loaded when using the boot options 2 and 3 will not be automatically saved to the camera's flash memory. Upon starting the camera the next time, the camera will use the last configuration it stored. You can store the configuration in the camera's flash memory using the **Admin Menu > Store** command.

**CAUTION!**

Note that you can restore specific parts of the camera configuration afterward by using "Restore" to re-apply the settings still stored in the camera.

As opposed to resetting the camera using **Admin Menu > Reset configuration to factory defaults**, the user information will not be reset if the camera is booted using the factory defaults.

When starting the camera with DHCP support (option 2), make sure that the network has a properly functioning DHCP server. If this is not the case, the camera cannot obtain a valid IP address and will fall back to its last IP address.

You should also make sure that the cameras always get the same IP addresses by mapping the MAC addresses of the cameras to the desired IP addresses.

## Network Settings

Once the camera has been connected to the network, you need to set up the MOBOTIX camera's network interface accordingly. This step involves setting up and checking the network parameters of the camera. If your network has an active DHCP server or if it is already running on a 10.x.x.x network with a 255.0.0.0 network mask) you do not need to change the camera's network parameters. You can directly access the camera. If neither your network nor your computer use an IP address in the 10.x.x.x network (e.g. a 192.168.x.x or 172.x.x.x network), you should follow one of the following methods for changing the camera's network parameters:

- Manual setup
- Automatic setup using MxManagementCenter

**NOTE!** For the following examples, we will use a camera with the factory IP address 10.16.0.99. Replace this IP address with the IP address of your camera. You will find this address on a small sticker on the camera. Make sure that the IP addresses used in the following examples are not used by any other devices on your network.

## Windows

1. Open the Windows **Control Panel > Network and Internet > Network and Sharing Center > Change Adapter Settings > Ethernet.**

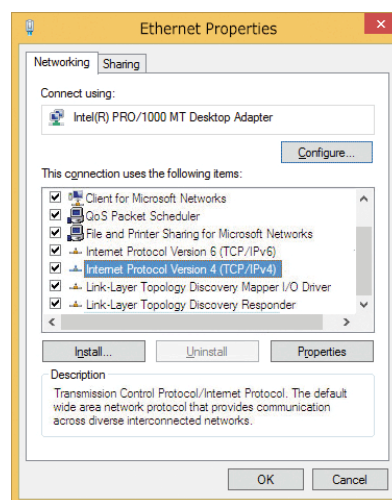

2. Right-click on the relevant network adapter and select **Properties.**
3. Open the properties of **Internet Protocol Version 4 (TCP/IPv4).**

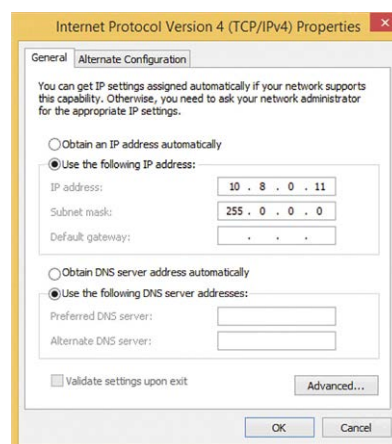

4. Activate **Use the following IP-address.** Enter an IP address in the 10.x.x.x range in this field (e.g. 10.16.0.11).
5. Click on **OK** to apply the settings.

## Mac

1. Open **System Settings > Network**.



2. Click on **Ethernet** and in the **Configuration** field, select the *Manual* list entry and enter an IP address in the 10.x.x.x IP address range (e.g., 10.16.0.11).
3. Click on **Apply** to apply the settings.

## Linux / Unix

1. Open a terminal as `root` user.
2. Enter the following command: `ifconfig eth0:1 10.16.0.11`.
3. The computer now has the additional IP address 10.16.0.11.

## Network Settings on the Camera in the Webbrowser

1. Use a web browser to access the web interface of the MOBOTIX camera and enter the factory IP address (e.g. 10.16.0.99).

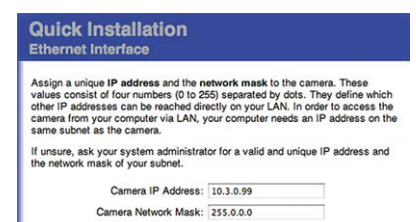

2. Click on the **Admin Menu** button in the user interface of the camera. The Quick Installation automatically starts after entering the access credentials of the admin user.

**NOTE!** Factory access credentials:

*User name:*admin

*Password:*meinsm

**NOTE!** You can also run the Quick Installation later on (**Admin Menu > Network Configuration > Quick Installation**; see Reference Manual).

3. Enter the network parameters of the camera in the course of the quick installation.

**NOTE!** You can also change the network parameters later on by running **Admin Menu > Network Configuration > Quick Installation**.

4. Reboot the camera to apply the network settings.

## Network Settings on the Camera in MxMC

MxManagementCenter is a video management software for setting up and using the entire video surveillance system that provides a range of functions for different tasks and user groups. You can download the newest release of MxManagementCenter from the MOBOTIX website ([www.mobotix.com](http://www.mobotix.com) > Support > Download Center > Software Downloads, MxManagementCenter section).

When starting MxManagementCenter for the first time, the configuration wizard opens and automatically starts searching for MOBOTIX cameras. The number of found cameras is shown as a counter next to the **Add Devices** icon. This number is updated automatically if the number of MOBOTIX cameras on the network has changed (i.e., by connecting new/disconnecting existing cameras).

1. Click on **Add Devices**. The cameras are displayed either in a list or as tiles. Use the List and Tile buttons to change the display mode.



The application automatically monitors and displays the operating status of all cameras using corresponding icons.

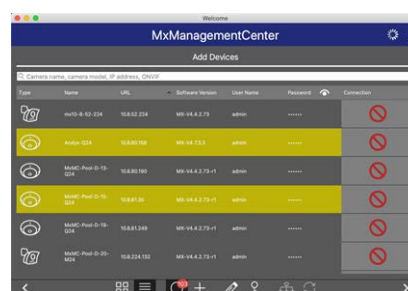

**EXAMPLE:**

- The camera is not in the same subnet as the computer.
- The user name and password of the camera are not known.

**NOTE!** Using the Bonjour service ([en.wikipedia.org/wiki/Bonjour\\_\(software\)](https://en.wikipedia.org/wiki/Bonjour_(software))), the application finds not only MOBOTIX cameras on the same subnet, but also in other subnets. Normally, you would not be able to establish any connection to cameras in a different network or subnet.

**NOTE!** This is the case, for example, if you are integrating cameras into a network without DHCP server (i.e. with fixed IP addresses) and the IP address range is different from the 10.x.x.x range supported by the cameras in addition to DHCP.

MxManagementCenter can automatically configure such a camera so that it is "integrated" into your existing network.

2. Select the camera you want to set up and click on **Edit Network Settings**  at the bottom of the program window. The **Change Network Settings for Selected Devices** dialog opens.

3. Enter the IP address and the subnet mask of the selected camera.



**NOTE!** The IP addresses of the other cameras are automatically incremented by 1.

4. Click on **Apply** to apply the settings.

**NOTE!** For more information on this feature, please read the MxManagementCenter online help or the Tutorial (see [www.mobotix.com](http://www.mobotix.com) > Support > Download Center > Documentation > Brochures & Guides > Tutorials).





## Camera Software in the Browser

The integrated software of the MOBOTIX v71 features a multitude of functions, such as video motion detection, long-term recording, alarm messaging and video IP telephony. Especially remarkable are the AI-based analytics features and the possibility to install third-party apps on the camera. Thanks to the virtual PTZ features, you can continuously zoom into or out of the live image using either the mouse wheel or a joystick.

When recording images or video sequences, you can choose to store either the visible image area of the live image or the full sensor image. This also allows examining the parts of an image or video that had not been visible in the real-time image section on display at the time of the recording.

Instead of using a web browser, you can also download the free MxManagementCenter from the MOBOTIX website ([www.mobotix.com](http://www.mobotix.com) > Support), which allows displaying multiple cameras on one monitor, allows for comfortably searching and evaluating the alarm video clips with audio and provides alerting features. For mobile iOS and Android devices, the free-of-charge MOBOTIX MOBOTIX LIVE App is available.

This section contains the following information:

<b>Access the Camera in the Web Browser</b> .....	<b>66</b>
<b>Basic Settings</b> .....	<b>66</b>

# Access the Camera in the Web Browser

Once the power and network connection of the MOBOTIX have been established, you can access the interface of the camera software in a web browser.

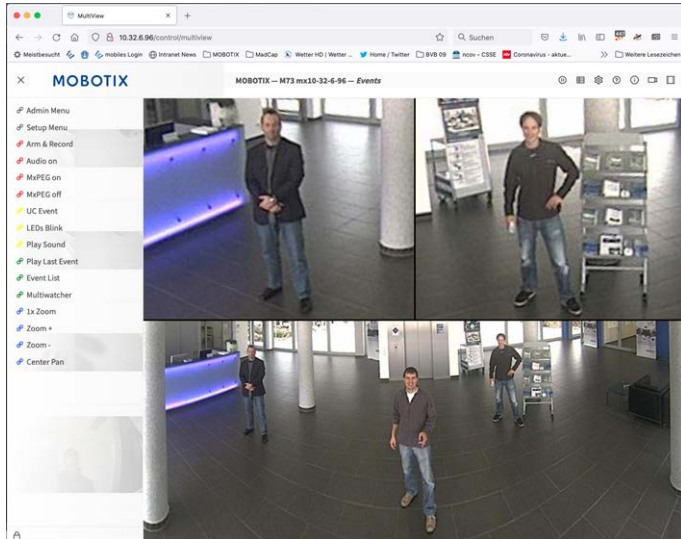

1. Enter the camera's IP address in the address field of a web browser.

**NOTE!** You can find the IP address of the camera, for example, in the camera housing or on the sticker on the packaging.

## Basic Settings

**Password for the Administration Menu:** Accessing the administration area of the camera (Admin Menu button) in the browser is only possible after entering a user name and password.

- **Default user name:** admin
- **Default password:** meinsm

**NOTE!** You must change the password when logging in for the first time.

**CAUTION!** Make sure that you store information on user names and passwords in a secure place. If you lose the administrator password and cannot access the Administration menu, the password can only be reset at the factory. This service is subject to a service charge.

The Quick Installation wizard will appear automatically when accessing the Administration Menu for the first time. It provides an easy method to adjust the basic camera settings to the current application scenario. For

security reasons, it is highly recommended to change the default administrator password after the camera has been configured properly.

**Administering the camera:** You can modify the camera configuration in the Administration Menu or the Setup Menu:

- **Admin Menu:** This menu contains the basic configuration dialogs of the camera (e.g. passwords, interfaces, software update).
- **Setup Menu:** This menu contains the dialogs for configuring the image, event and recording parameters. Some of these settings can be changed using the corresponding Quick Controls in the Live screen.

**NOTE!** For more information, consult the Reference Manual of the camera.



## Maintenance

This section contains the following information:

<b>Replacing the microSD card</b> .....	<b>70</b>
<b>Cleaning the Camera</b> .....	<b>71</b>

# Replacing the microSD card

**CAUTION!** To remove, insert or exchange the microSD card, the camera must be disassembled.

Before removing the microSD card, deactivate the recording function and restart the camera. Non-observance can lead to data loss!

The microSD card must not be write-protected!

Do not touch the circuit board when exchanging the microSD card!

## Step by step

1. **Deactivate storage:** If storage on microSD card is still activated deactivate it in the cameras web interface: **Admin Menu > Storage on external file server / flash media**, then reboot the camera .
2. **Open the screw cap:** Using a coin or wide screwdriver, turn the screw cap ① on the back of the camera to the left and remove it.



3. **Unlock the microSD card holder:** Flip up the metal cover ② of microSD card (e.g. with a fingernail).



4. **Remove the microSD card**
5. **Insert microSD card:** Insert the new microSD card in the holder and close the metal cover with light pressure until it snaps in.
6. **Close the screw cap:** Reinsert the screw cap and turn it to the right using a wide screwdriver.

7. **Activate storage:** If the microSD card already is formatted with MxFFS has been inserted, storage can be activated in Admin Menu > Storage on External File Server/Flash Device. After rebooting the camera, recording is activated automatically. .

## Cleaning the Camera

Clean the camera housing using a mild alcohol-free detergent without abrasive particles.

To protect the camera from damage, only use the supplied mounting supplies (see [Mounting Supplies: Scope of Delivery, p. 21](#)).

# MOBOTIX

BeyondHumanVision

EN\_08/24

MOBOTIX AG • Kaiserstrasse • D-67722 Langmeil • Tel.: +49 6302 9816-103 • sales@mobotix.com • www.mobotix.com

MOBOTIX is a trademark of MOBOTIX AG registered in the European Union, the U.S.A., and in other countries. Subject to change without notice. MOBOTIX do not assume any liability for technical or editorial errors or omissions contained herein. All rights reserved. © MOBOTIX AG 2019