

# User Guide

## MOBOTIX MOVE 5MP Varifocal IR Vandal Turret

© 2024 MOBOTIX AG



BeyondHumanVision

MOBOTIX MOVE

# Table of Contents

---

<b>Table of Contents</b> .....	<b>2</b>
<b>Before You Start</b> .....	<b>5</b>
Support .....	6
MOBOTIX Support .....	6
MOBOTIX eCampus .....	6
MOBOTIX Community .....	6
Safety Notes .....	7
Legal Notes .....	7
<b>Overview</b> .....	<b>9</b>
Features .....	10
Package Contents .....	10
Accessories for Vandal Turret Cameras .....	11
Dimensions .....	12
Accessories for All Cameras .....	13
Further Reading .....	18
<b>Connection</b> .....	<b>21</b>
Connecting Power .....	22
Connecting Ethernet Cable .....	22
<b>Installation</b> .....	<b>23</b>
General Remarks .....	24
<b>Configuration</b> .....	<b>25</b>
System Requirements for Operating the Camera .....	26
Accessing the Camera .....	26
Web Interface - Basic Functions .....	27
Live View .....	28
Media Player .....	28
Lens Control .....	29
Media Player .....	30
Lens Control .....	30
Video Analytics .....	31
Configuration .....	31
Encode .....	32
Image .....	35
Lens Control .....	40
Video .....	41

Network .....	45
System .....	59
Account .....	64
Event Source .....	67
Video Analytics .....	76
Event Setting .....	81
<b>Technical Support Information .....</b>	<b>89</b>
Technical Specifications .....	90



## Before You Start

This section contains the following information:

<b>Support</b> .....	<b>6</b>
<b>Safety Notes</b> .....	<b>7</b>
<b>Legal Notes</b> .....	<b>7</b>

# Support

## MOBOTIX Support

If you need technical support, please contact your MOBOTIX dealer. If your dealer cannot help you, he will contact the support channel to get an answer for you as quickly as possible.

If you have internet access, you can open the MOBOTIX help desk to find additional information and software updates.

Please visit [www.mobotix.com](http://www.mobotix.com) > [Support](#) > [Help Desk](#).



## MOBOTIX eCampus

The MOBOTIX eCampus is a complete e-learning platform. It lets you decide when and where you want to view and process your training seminar content. Simply open the site in your browser and select the desired training seminar.

Please visit [www.mobotix.com/ecampus-mobotix](http://www.mobotix.com/ecampus-mobotix).



## MOBOTIX Community

The MOBOTIX community is another valuable source of information. MOBOTIX staff and other users are sharing their information, and so can you.

Please visit [community.mobotix.com](http://community.mobotix.com).



## Safety Notes

- This camera must be installed by qualified personnel and the installation should conform to all local codes.
- This product must not be used in locations exposed to the dangers of explosion.
- Do not use this product in a dusty environment.
- Protect this product from moisture or water entering the housing.
- Install this product as outlined in this document. A faulty installation can damage the product!
- Do not replace batteries of the camera. If a battery is replaced by an incorrect type, the battery can explode.
- This equipment is not suitable for use in locations where children are likely to be present.
- External power supplies must comply with the Limited Power Source (LPS) requirements and share the same power specifications with the camera.
- When using a power adapter, the power cord shall be connected to a socket-outlet with proper ground connection.
- To comply with the requirements of EN 50130-4 regarding the power supply of alarm systems for 24/7 operation, it is highly recommended to use an uninterruptible power supply (UPS) for backing up the power supply of this product.

## Legal Notes

### Legal Aspects of Video and Sound Recording

You must comply with all data protection regulations for video and sound monitoring when using MOBOTIX AG products. Depending on national laws and the installation location of the cameras, the recording of video and sound data may be subject to special documentation or it may be prohibited. All users of MOBOTIX products are therefore required to familiarize themselves with all applicable regulations and to comply with these laws. MOBOTIX AG is not liable for any illegal use of its products.

### Declaration of Conformity

The products of MOBOTIX AG are certified according to the applicable regulations of the EC and other countries. You can find the declarations of conformity for the products of MOBOTIX AG on [www.mobotix.com](http://www.mobotix.com) under **Support > Download Center > Marketing & Documentation >**

## Certificates & Declarations of Conformity.

### RoHS Declaration

The products of MOBOTIX AG are in full compliance with European Unions Restrictions of the Use of Certain Hazardous Substances in Electrical and Electronic Equipment (RoHS Directive 2011/65/EC) as far as they are subject to these regulations (for the RoHS Declaration of MOBOTIX, please see [www.mobotix.com](http://www.mobotix.com), **Support > Download Center > Marketing & Documentation > Brochures & Guides > Certificates**).

### Disposal

Electrical and electronic products contain many valuable materials. For this reason, we recommend that you dispose of MOBOTIX products at the end of their service life in accordance with all legal requirements and regulations (or deposit these products at a municipal collection center). MOBOTIX products must not be disposed of in household waste! If the product contains a battery, please dispose of the battery separately (the corresponding product manuals contain specific directions if the product contains a battery).

### Disclaimer

MOBOTIX AG does not assume any responsibility for damages, which are the result of improper use or failure to comply to the manuals or the applicable rules and regulations. Our General Terms and Conditions apply. You can download the current version of the **General Terms and Conditions** from our website at [www.mobotix.com](http://www.mobotix.com) by clicking on the corresponding link at the bottom of every page. It is the User's responsibility to comply with all applicable local, state, national and foreign laws, rules, treaties and regulations in connection with the use of the Software and Product, including those related to data privacy, the Health Insurance Portability and Accountability Act of 1996 (HIPPA), international communications and the transmission of technical or personal data.



## Overview

This section contains the following information:

<b>Features</b> .....	<b>10</b>
<b>Package Contents</b> .....	<b>10</b>
<b>Accessories for Vandal Turret Cameras</b> .....	<b>11</b>
<b>Accessories for All Cameras</b> .....	<b>13</b>
<b>Further Reading</b> .....	<b>18</b>

## Features

The MOBOTIX MOVE 5MP Varifocal IR Vandal Turret is designed to bring clarity and vigilance to your surveillance needs. This state-of-the-art turret camera with DNN-based video analytics combines advanced features with a compact and sleek design, making it an ideal choice for various indoor and outdoor applications. The Vari-Focal Turret Camera allows you to easily remote adjust the field of view and focus by a motorized lens, ensuring optimal positioning and alignment to meet the specific requirements of your surveillance scenario. The camera's weather-resistant design IP67 and IK10 ensures reliable operation even in challenging environmental conditions. Its compact turret form factor, combined with easy installation options, makes it a hassle-free choice.

- High Low-Light sensitivity
- 1/2.8" Progressive CMOS
- Motorized Vari-Focal Lens 2.7mm to 13.5mm
- WDR up to 120 dB
- Integrated adaptive IR Illumination, working distance up to 30 m/98 ft
- Triple Streaming H.264/H.265/MJPEG
- 2D & 3D Motion Compensated Noise Reduction (MCTF)
- ONVIF Profile S/G/T/M support
- Micro SD Card supports up to 512 GB.
- Integrated Microphone
- NDAA compliant
- DNN-based object detection with filtering (people/vehicles, etc.)
- Dual power Supply IEEE802.3af Class 3 / DC 12 V
- Temp. Range -30°C to 60°C/-22°F to 140 °F with heater
- Protection Rate IP67 / IK10
- Intelligent Encoding, Smart Low Bitrate Control is same as Smart compression offering optimally useable bandwidth and storage.

**NOTE!** Observe the [MOBOTIX MOVE Installation Hints](#) document to ensure optimum performance of the camera features.

## Package Contents

Check the package for the items listed below.

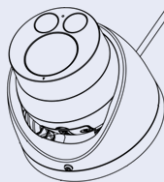

5MP Varifocal IR Vandal Turret



3 x Plastic anchors



3 x self tapping screws



1 x Cable entry cover



1 x Water proof cover



1 x Security Torx Wrench (T 1 0) \* 1



1 x Drilling template

## Accessories for Vandal Turret Cameras

Order Code/ Picture	Description	Compatible Products	Material/ Color	Weight
<p>Mx-M-VT-AP</p> 	Adapter mounting plate for MOVE Vandal Turret cameras.	MOVE Vandal Turret (VT) cameras.	Aluminum, RAL9003	0.3 kg
<p>Mx-M-VT-JB</p> 	Junction box for MOVE Vandal Turret cameras.	MOVE Vandal Turret (VT) cameras.	Aluminum, RAL9003	0.85 kg
<p>Mx-M-VT-WM</p> 	Wall mount for MOVE Vandal Turret cameras.	MOVE Vandal Turret (VT) cameras.	Aluminum, RAL9003	0.3 kg

# Dimensions

## Order Code

## Dimensions

Mx-M-VT-AP

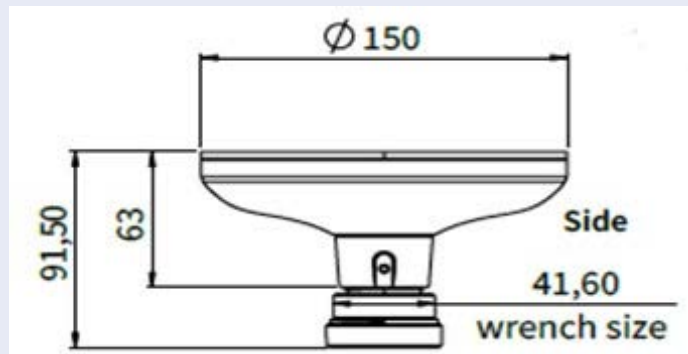

Mx-M-VT-JB

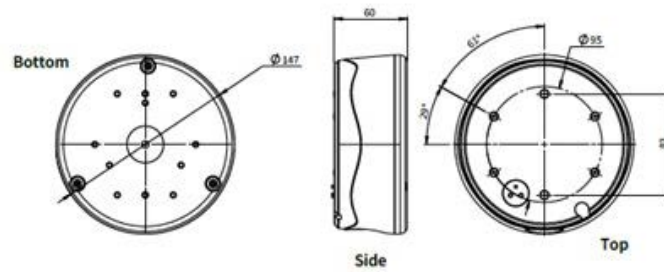

Mx-M-VT-WM

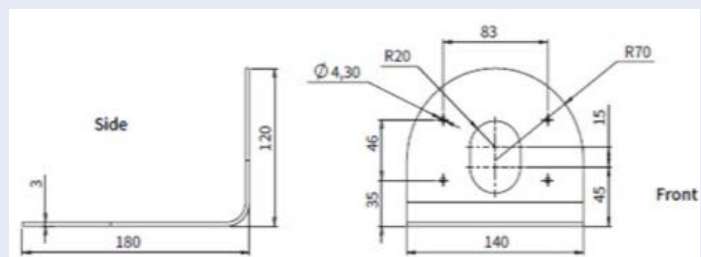

# Accessories for All Cameras

## Overview

### Accessories for All Cameras

Order Code/ Picture	Description	Compatible Products	Material/ Color	Weight
<p>MX-NPA-UPOE1A-60W</p> 	<p>UPoE Power Injector 60W.</p> <p>PoE++ 60W Network Power injector • AC Input Voltage: 100 to 240 VAC (50 to 60Hz) • AC Input Current: 1.5A @100-240 VAC • Operating Ambient Temperature: • -10° to 40°C @60W • -10° to 50°C, humidity 10 to 90% @30W • IEEE 802.3bt com- pliant • Output power of 60W over 4-pairs • Sup- ports 10/100/1000Base-T applications • Plug-and- play installation • Full Protection OVP, OCP• Supports 10/100/1000Base-T applications.</p>	<p>All cameras.</p>	<p>Plastic housing, black</p>	<p>0.45 kg</p>

Order Code/ Picture	Description	Compatible Products	Material/ Color	Weight
Mx-A-ETP1A-2601-SET	<p>Media converter set Ethernet(PoE+) – Twisted-Pair.</p> <p>Complete set consisting of two two-wire transmit/receive units for establishing an Ethernet transmission path via twisted-pair cables. • Transmission of Ethernet and PoE+ power supply via two-wire line according to IEEE1901. • Simple connection of 10/100 Mbps Ethernet end devices • Max. 95 Mbps transmission bandwidth, range up to 600 m/656 yd for data only, 300 m/328 yd for PoE depending on the quality of the twisted-pair link • 128 bit AES network data encryption • Power supply 2-wire transmitter (Tx) and receiver (Rx) as well as end device via PoE+ network switch or external power supply 56VDC / 1.2A (not included!) • Connected end devices are supplied via PoE switch IEEE802.3af(PoE), IEEE802.3at (PoE+), UPoE up to 60W (requires ext. power supply unit). •</p>	All cameras. Requires Mx-A-ETP1A-2601-POW.	Plastic housing, black	0.368 kg



## Overview

### Accessories for All Cameras

Order Code/ Picture	Description	Compatible Products	Material/ Color	Weight
	Status LEDs (data, power supply, data link, PoE) • Integrated Overvoltage protection (IEC 61000-4-5 4kV(1.2 / 50us), 2kA(8 / 20us)) • Power Supply: TX: T-Linx or DC12V~57V, RX: PoE Switch or DC48V~57V • Operational temperature: -20 to 60°C • Dimensions: 80.4(L) x 61.6(W) x 24(H)mm • Weight: RX/TX: 102g • Warranty: 2 years			
Mx-A-ETP1A-2601-POW 	Plug-type power supply for Mx-A-ETP1A-2601-SET.  Output: 57V DC +/-3% / 1.2 A • Input: 90-260V AC (47-63Hz) • 68,4 Watt • Operating Temperature: 0-40°C/32-122°F	Mx-A-ETP1A-2601-SET	Plastic housing, black	0.49 kg



Order Code/ Picture	Description	Compatible Products	Material/ Color	Weight
Mx-A-KBD1A-PTZ-JOG 	<p>MOBOTIX USB Keyboard with PTZ Joystick &amp; Jog-Shuttle.</p> <p>USB control panel for operating MOBOTIX MxMC 2.6 and higher and MOBOTIX HUB incl. Control of software PTZ and motorized PTZ cameras and pan/tilt devices • Integrated 3-axis joystick • Integrated jog shuttle • 38 control keys with backlight predefined for MxMC functions or freely definable for MOBOTIX HUB • Integrated alarm buzzer • Suitable for operation as HID device on MOBOTIX VMS with Windows and MAC based operating systems via USB 2.0 • Suitable for right- and left-handed users • Power supply: USB, max. 350 mA • Operating temperature: 0°–45°C/32–113 °F.</p>	<p>All cameras. Requires Windows or macOS computer with USB 2.0 or better.</p>	<p>Plastic housing, black</p>	<p>1.9 kg</p>

## Overview

### Further Reading

---

Order Code/ Picture	Description	Compatible Products	Material/ Color	Weight
MX-SWITCH1 	<p>MOBOTIX network switch for DIN (top-hat) rail mounting.</p> <p>5x RJ45 port with 100 MBit/s (1x uplink, 4x PoE+ with max. 75 W). Supply: 48 V DC, max. 75 W. Simplified cabling for door stations due to available connectivity for anti-theft protection, door opener and MxBus. MxBus, anti-theft protection, door and lock contact can be connected via separate wires of Ethernet cable.</p>	All cameras.	Plastic housing, gray	0.31 kg

## Further Reading

[Manuals and Quick Installation documents](#)



[Technical Specifications](#)



[MOBOTIX MOVE Installation Hints](#)



[MOBOTIX Community](#)





## Connection

This section contains the following information:

<b>Connecting Power</b> .....	<b>22</b>
<b>Connecting Ethernet Cable</b> .....	<b>22</b>

# Connecting Power

## Using Power over Ethernet (PoE)

# Connecting Ethernet Cable

## Ethernet Cable Connection

### NOTE!

- The length of the Ethernet cable should not exceed 100 m/300 ft.
- Check the status of the link indicator and the activity indicator LEDs of the switch. If the LEDs are unlit, please check the LAN connection.
- In some cases, an Ethernet crossover cable may be needed when connecting the camera directly to the PC.

## Ethernet Connector LEDs

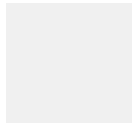

- Green **Link** LED indicates good network connection.
- Orange **Activity** LED flashes to indicate network activity.

## Installation

This section contains the following information:

<b>General Remarks .....</b>	<b>24</b>
------------------------------	-----------

## General Remarks

Read the instructions provided in this chapter thoroughly before installing the camera.

**NOTE!** This camera must be installed by qualified personnel and the installation must conform to all local codes.

**NOTE!** Observe the [MOBOTIX MOVE Installation Hints](#) document to ensure optimum performance of the camera features.



## Configuration

This section contains the following information:

<b>System Requirements for Operating the Camera</b> .....	<b>26</b>
<b>Accessing the Camera</b> .....	<b>26</b>
<b>Web Interface - Basic Functions</b> .....	<b>27</b>
<b>Live View</b> .....	<b>28</b>
<b>Media Player</b> .....	<b>28</b>
<b>Lens Control</b> .....	<b>29</b>
<b>Configuration</b> .....	<b>31</b>

# System Requirements for Operating the Camera

To operate the IP camera via web browser, please ensure the PC is in good network connection and meets system requirements as described below.

## System Hardware

CPU	i5-2430M CPU@ 2.40GHZ
RAM	6 GB or above
Display	NVIDIA GeForce 6 Series or ATI Mobility Radeon 9500
Power Supply	PoE (IEEE 802.3af Class 3)
Network	10/100BASE-T Ethernet (RJ-45 connector)

## System Software

Operating System	Microsoft Windows 10 or above, MacOS Sierra or above
Browser	Mozilla Firefox, Google Chrome, Apple Safari, Microsoft Edge

---

## Accessing the Camera

### NOTE!

This MOBOTIX MOVE camera is designed for full integration with MOBOTIX and third-party software and recording solutions using common ONVIF S/G/T&M profiles.

When integrating this camera into MOBOTIX environments (e.g. MOVE NVR, MOVE CMS, MOBOTIX HUB MxMC, MOBOTIX CLOUD etc.) or third-party software, please use the ONVIF device search and integration method only.

The IP address of the camera can be found on the label on the camera housing.

1. Access the IP address of the camera with a web browser.
2. If you are accessing the camera's web interface for the first time, you must change the administrator password for user "ADMIN".

### This Camera is Not Secure

Please setup the password for this device.

User Name:

Password:

Re-type Password:

#### NOTE!

The password must include at least

- 8 characters including
- 1 uppercase letter
- 1 special character

## Web Interface - Basic Functions

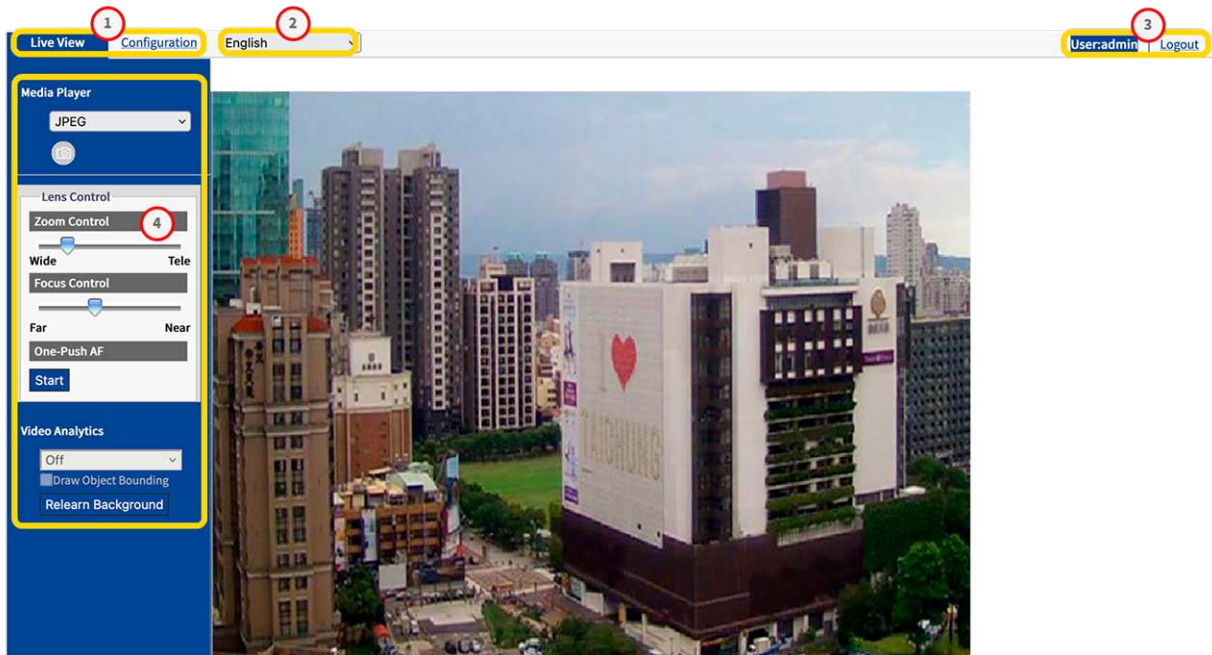

**View Selection ①** : Select between Live View and Configuration View.

**Language Menu ②** :Select your preferred user interface language.

## Configuration

### Live View

---

**User ③** : Here you see the currently logged in user and you can log this user out.

**Control Panel ④** : The Live View contains functions for camera and image control. In the Configuration View, a navigation menu is located here.

## Live View

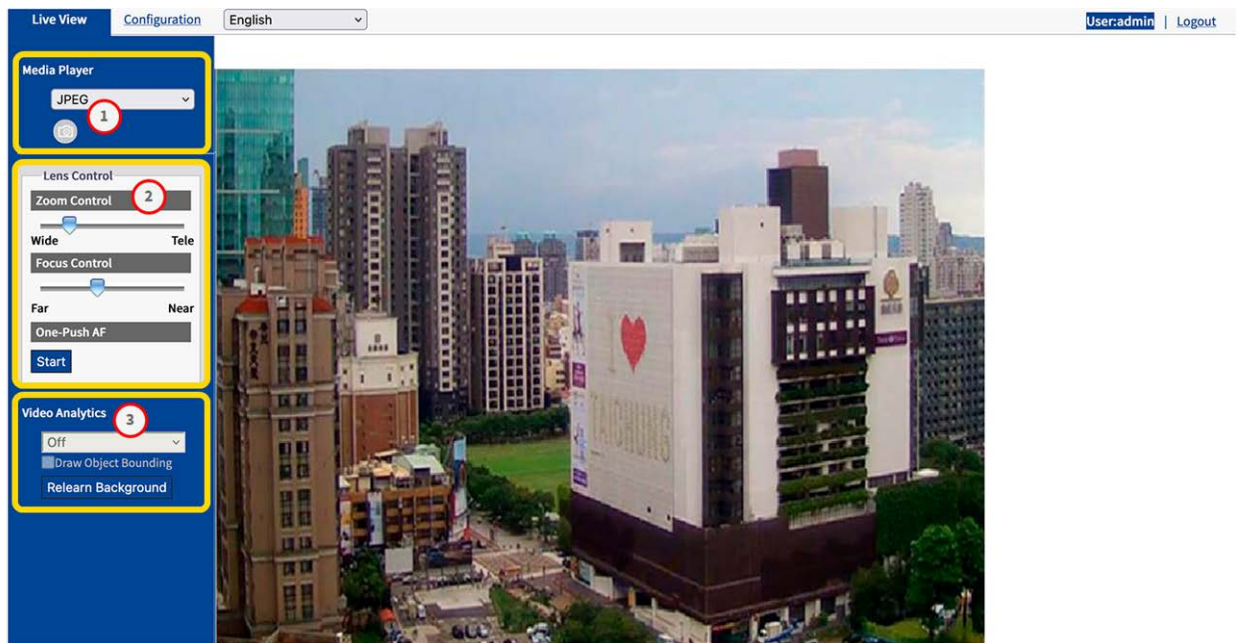

In “Live View”, you can control the live image with the following functions:

- Media Player ①
- Lens Control ②
- Video Analytics ③

## Media Player



The Media Player provides the following functions:

---

**Streaming format:** In the drop-down menu ① Select the streaming format for the live image

**JPEG**

**H.264**

**Snapshot:** Click on the camera icon ② to create and save a snapshot from the current live image.

## Lens Control

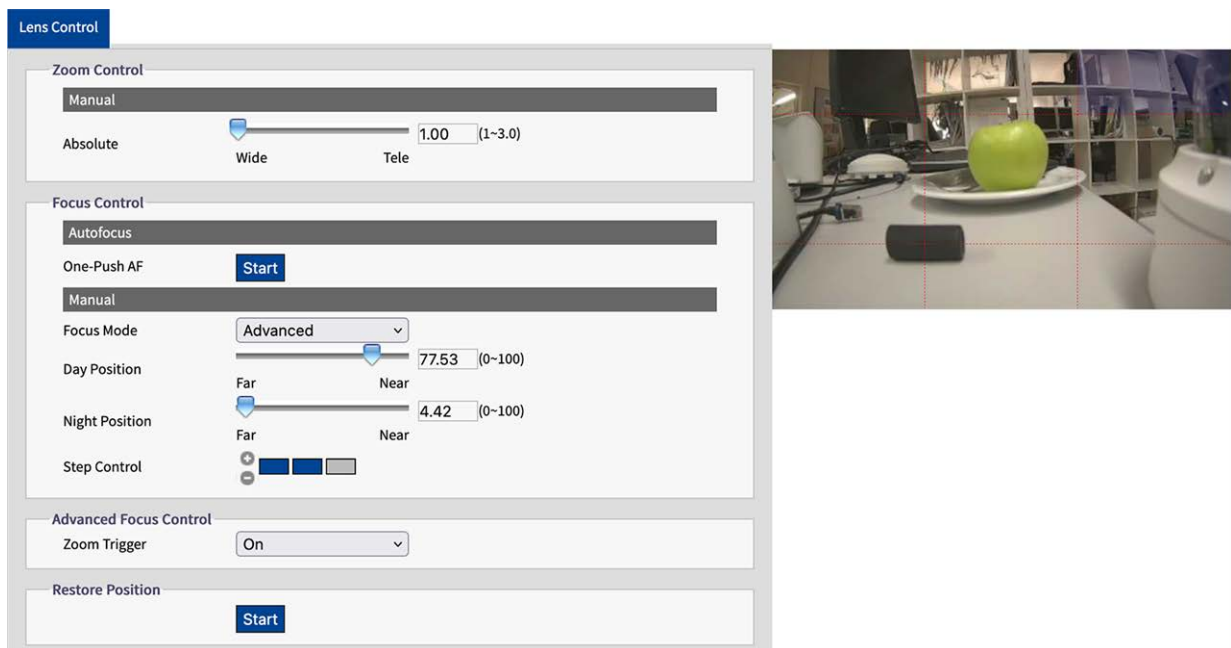

The screenshot displays the 'Lens Control' interface. It features a 'Zoom Control' section with a 'Manual' slider set to 1.00 (range 1-3.0) between 'Wide' and 'Tele' positions. Below it is the 'Focus Control' section, which includes an 'Autofocus' button, a 'One-Push AF' button labeled 'Start', and a 'Manual' section with a 'Focus Mode' dropdown set to 'Advanced'. The 'Day Position' slider is set to 77.53 (range 0-100) between 'Far' and 'Near' positions. The 'Night Position' slider is set to 4.42 (range 0-100) between 'Far' and 'Near' positions. There is also a 'Step Control' section with three buttons. The 'Advanced Focus Control' section has a 'Zoom Trigger' dropdown set to 'On'. At the bottom, there is a 'Restore Position' button labeled 'Start'. To the right of the controls is a live video feed showing a green apple on a white plate on a table, with a red dashed box indicating the current focus area.

The Lens Control features are

**Zoom Control:** Move the zoom control slider ① to Wide or Tele.

**Focus Control:** Move the Focus control slider ② to Far or Near.

**One-Push-AF:** Click Start ③ to set the Auto Focus on the current scene.

For more information about Lens Control see

## Media Player



The Media Player provides the following functions:

**Streaming format:** In the drop-down menu ① Select the streaming format for the live image:

**JPEG**

**H.264**

**Snapshot:** Click on the camera icon ② to create and save a snapshot from the current live image.

## Lens Control

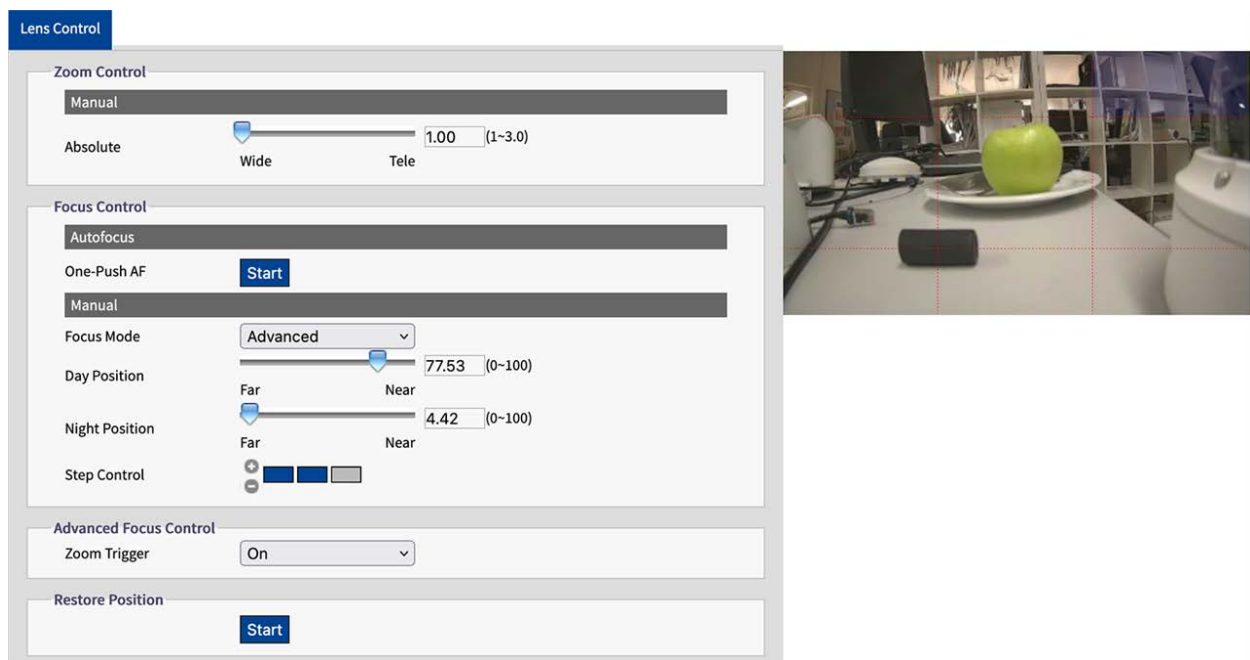

The Lens Control features are

**Zoom Control:** Move the zoom control slider ① to Wide or Tele.

**Focus Control:** Move the Focus control slider ② to Far or Near.

**One-Push-AF:** Click Start ③ to set the Auto Focus on the current scene.

For more information about Lens Control see

## Video Analytics

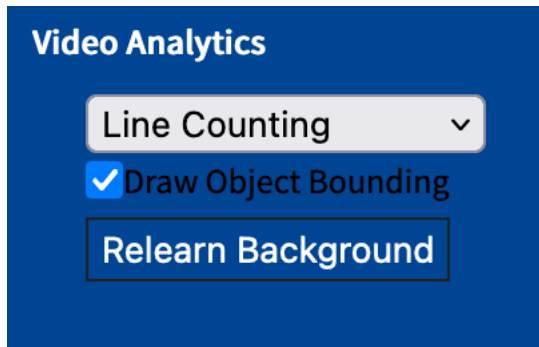

The Lens Control features are

**Analytics Type:** When configured you can choose from Line Counting or Border Line. Also see

**Draw Object Bounding:** Activate to draw a bounding box around detected objects..

**Relearn Background:** Click to relearn the background e.g. if the scene to be analyzed has changed.

For more information about Lens Control see

## Configuration

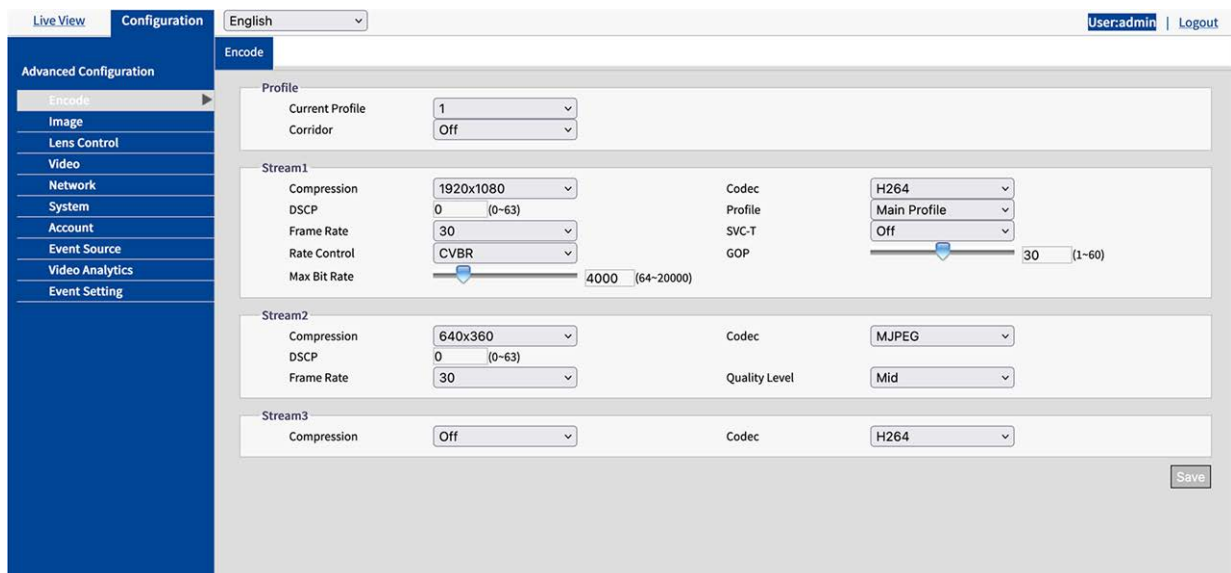

Depending on your user rights you can access the “Configuration View”, where you can configure the camera regarding the following sections:

- Encode
- Image

## Configuration

### Configuration

- Lens Control
- Video
- Network
- System
- Account
- Event Source
- Video Analytics
- Event Setting

## Encode

For optimum video quality for different network environments and applications, you can configure up to three different profiles, each with three streams.

Exposure White Balance Basic Setting

Basic Setting

Exposure Mode	Auto
Digital WDR	Off
Max Shutter time	1/60
Min Shutter time	1/10000
P Iris Control	Auto
EV	0
BLC	Off

Day Night Setting

Day Night Switch Control

Mode	Auto
Time	Normal

Day To Night

Sensitivity

Night To Day

IR Control

IR Mode	Auto
Smart IR	Off
Adaptive IR	Off

Broad

Narrow

Adjustable IR Level

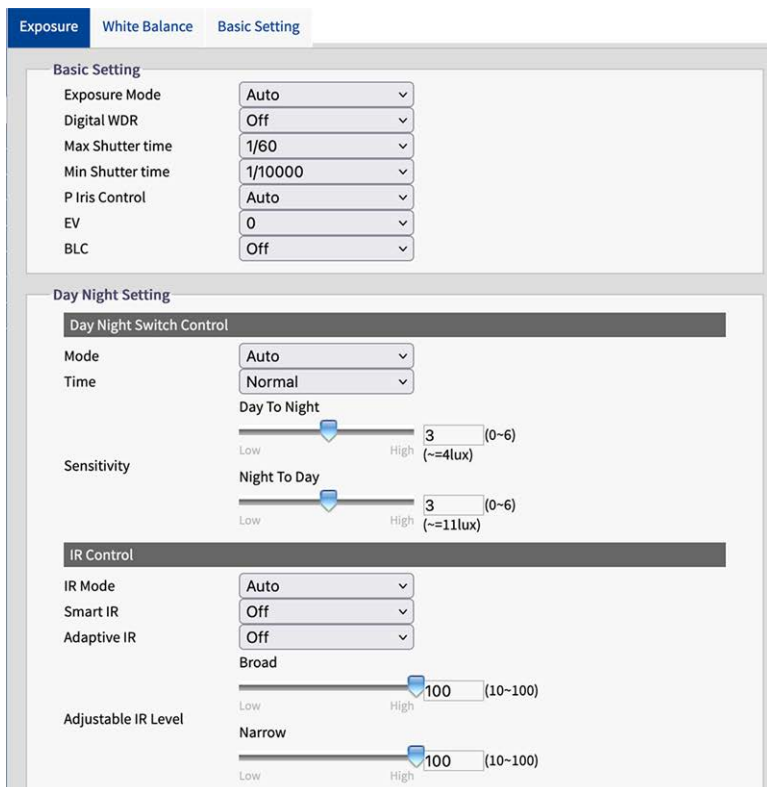

## Profile

You can define up to three video profiles.



Profile	
Current Profile	1
Corridor	Off

**Current Profile:** Select the profile you to be edited.

**Corridor:** Activate or deactivate the corridor format. The corridor format is suitable for monitoring scenes that require a vertical image orientation, for example corridors.

**On:** The image is aligned vertically.

**Off:** Default, the Image is aligned horizontally.

## Stream (1/2/3)

You can define up to three video streams per profile. Each stream can be based on MJPG, H.264 or H.265.

Stream1			
Compression	1920x1080	Codec	H264
DSCP	0 (0-63)	Profile	Main Profile
Frame Rate	30	SVC-T	Off
Rate Control	CVBR	GOP	30 (1-60)
Max Bit Rate	4000 (64-20000)		
Stream2			
Compression	640x360	Codec	MJPEG
DSCP	0 (0-63)	Quality Level	Mid
Frame Rate	30		
Stream3			
Compression	Off	Codec	H264

Save

## MJPG

MJPEG (Motion JPEG) is a video codec in which each individual frame is compressed separately as a JPEG image. Videos compressed with MJPEG have a quality that is independent of the movement of the image and in which each individual image can be evaluated or saved. The MJPG format usually requires a lot of bandwidth and storage space.

**Compression:** Select the video resolution 2592×1944, 1920×1440, 1920×1080, 1280×960, 1280×720, 800×600, 640×480, 640x360, 320x240.

**DSCP:** Set a value from 0 (default) to 63. DSCP (Differentiated Services Code Point) is a scheme for classifying IP packets. This classification can be used by the network scheduler to prioritize IP data packets in order to ensure quality of service: The higher the value, the higher the priority.

**Frame Rate:** The frame rate indicates how many images (frames) are displayed per second. You can set a frame rate between 1 and 30 frames per second (fps). The higher the frame rate, the smoother the video stream.

**Quality Level:** Select a quality level of Low, Medium or High. "High" produces the best image quality (lowest compression of individual images), but results in a larger file size and requires more network bandwidth. In contrast, "Low" produces the lowest image quality with a smaller file size.

## H.264 / H.265

MJPEG (Motion JPEG) is a video codec in which each individual frame is compressed separately as a JPEG image. Videos compressed with MJPEG have a quality that is independent of the movement of the image and in which each individual image can be evaluated or saved. The MJPG format usually requires a lot of bandwidth and storage space.

**Compression:** Select the video resolution 2592×1944, 1920×1440, 1920×1080, 1280×960, 1280×720, 800×600, 640×480, 640×360, 320×240.

**DSCP:** Set a value from 0 (default) to 63. DSCP (Differentiated Services Code Point) is a scheme for classifying IP packets. This classification can be used by the network scheduler to prioritize IP data packets in order to ensure quality of service: The higher the value, the higher the priority.

**Frame Rate:** The frame rate indicates how many images (frames) are displayed per second. You can set a frame rate between 1 and 30 frames per second (fps). The higher the frame rate, the smoother the video stream.

### Rate Control:

**VBR:** With a variable bit rate, the bit rate of a video signal is varied during compression depending on the complexity of the underlying signals, with the aim of achieving constant quality.

**CBR:** With a constant bit rate, the bit rate of a video signal remains constant during compression, regardless of the complexity of the signal. The quality of the result can vary.

**CVBR:** Constrained Variable Bitrate (CVBR) is a method of encoding your video with an adaptive bitrate. Essentially, more bitrate is allocated if the video image is more complex and less bitrate is used if the video image is simply structured. Note that the higher the bitrate used, the larger the file size. CVBR may reduce the file size for simply structured scenes with few contrasts.

**Quality Level:** For VBR you can set a Quality Level between 1 and 10. "10" produces the best image quality but results in a larger file size and requires more network bandwidth. In contrast, "0" produces the lowest stream quality but requires less network bandwidth.

**CBR Bit Rate / Max Bit Rate:** Bit rate is the data transfer rate of digital multimedia formats such as audio or movie files. The bit rate indicates the ratio of the amount of data that is displayed in a certain amount of time. A bit rate that is too low can have a negative effect on the video quality, whereas a bit rate that is set too high causes a higher network load.

**Profile:** You can select a suitable profile for your application. The H.264 codec supports the Main Profile and High Profile profiles. The H.265 codec only supports the Main Profile.

**Baseline Profile:** Primary profile for lower-cost applications with limited hardware resources. This profile is used for video conferences and mobile applications.

**Main Profile:** This profile is intended for broadcast and more complex requirements.

**High Profile:** High Definition profile for broadcast and disk-storage applications. The High profile is primarily used for High Definition TV applications. The High profile is generally used for HD-DVDs and BluRay disks.

**SVC-T:** Switch SVC-T On or Off (default). Due to multi-browsers support, the performance of live view will vary according to the efficiency of each browser and client device. Consequently, the “Scalable Frame Rate” is introduced to help user dynamically adjust to a desired frame rate per browser applied for smooth video display. Please refer the Live view “Scalable Frame Rate” function, The option “Full” indicates a full frame rate display in response to the setting under “Encode” page, whereas “1/2” & “1/4” mean that display frame rate will be reduced to one half and one quarter respectively. Turn “SVC-T” on before using “Scalable Frame Rate” function.

**GOP:** Set a value from 1 to 60 (default: 30).

The Group of Pictures (GoP) is a group of consecutive frames in the image stream of a compressed digital video that are coded in dependence on one another. An MPEG stream essentially consists of I-frames and P-frames. An I-frame (intra-coded picture) is a reference picture which corresponds to a complete still picture, similar to a JPEG picture, and is independent of other picture types. A P-frame (predictive-coded picture) contains differential information from the previous I-frame.

The GoP length is defined by the distance between two I frames. A large GOP-length consumes less network bandwidth but e.g. in an unstable network is a higher risk of losing image data.

**NOTE!** The available GOP values depend on the frame rate.

## Image

In this section you can specify settings for Exposure, White Balance, and Basic Settings.

The screenshot displays the camera's configuration interface with three tabs: Exposure, White Balance, and Basic Setting. The Basic Setting tab is selected, showing the following parameters:

- Basic Setting**
  - Exposure Mode: Auto
  - Digital WDR: Off
  - Max Shutter time: 1/60
  - Min Shutter time: 1/10000
  - P Iris Control: Auto
  - EV: 0
  - BLC: Off
- Day Night Setting**
  - Day Night Switch Control**
    - Mode: Auto
    - Time: Normal
  - Sensitivity**
    - Day To Night: Slider set to 3 (range 0-6, ~4lux)
    - Night To Day: Slider set to 3 (range 0-6, ~11lux)
  - IR Control**
    - IR Mode: Auto
    - Smart IR: Off
    - Adaptive IR: Off
    - Adjustable IR Level**
      - Broad: Slider set to 100 (range 10-100)
      - Narrow: Slider set to 100 (range 10-100)

A live view image of a city building is shown on the right side of the interface.

# Exposure

Exposure

White Balance

Basic Setting

## Basic Setting

Exposure Mode	Auto	▼
Digital WDR	Off	▼
Max Shutter time	1/60	▼
Min Shutter time	1/10000	▼
P Iris Control	Auto	▼
EV	0	▼
BLC	Off	▼

## Day Night Setting

### Day Night Switch Control

Mode	Auto	▼
Time	Normal	▼

#### Day To Night



Sensitivity

#### Night To Day



### IR Control

IR Mode	Auto	▼
Smart IR	Off	▼
Adaptive IR	Off	▼

#### Broad



Adjustable IR Level

#### Narrow



## Basic Settings

**Mode:** Select one of these Modes:

**ATW:** ATW: "Auto Tracing White Balance" automatically controls the color temperature range.

**Auto:** This mode continuously adjusts the color balance of the camera to any change in color temperature.

**Manual:** In this mode, you can manually adjust the White Balance by adjusting red and blue color gain.

**R Gain:** Drag the slider to adjust the gain of red in the image.

**B Gain:** Drag the slider to adjust the gain of blue in the image.

**One Push:** Click on this button so that the camera automatically adjusts to the correct gain values.

## Day Night Setting

**Mode:** For the Day Night Switch Control select one of the following modes:

**Auto:** Auto lets the camera automatically switch between color mode and day/night mode, depending on the intensity of the lighting.

**Color:** The camera is forced to stay in Color mode permanently

**B/W:** The camera stays in black and white mode when B/W is selected.

**NOTE!** In Exposure Mode Manual only Color and B/W are available.

Depending on the selected Mode the following settings are available:

**Time:** Delay time for switching between day and night mode. Fast means that the camera switches constantly and almost without delay. Slow means that the camera has a longer buffer time before switching between day and night mode.

**NOTE!** Time is not available in Exposure Mode Manual.

**Sensitivity:** You can set the Day To Night and the Night To Day sensitivity. The sensitivity of the day/night switching mechanism. A higher value (High) means that the camera can automatically switch between day and night mode even if there is a slight change in light intensity.

**IR Mode:** Select "Auto" (default) so that the camera switches the IR LED on or off depending on the light intensity or depending on various applications. Select "On" so that the camera activates the IR LED permanently and "Off" to switch the IR LED off.

**Smart IR:** Activate Smart IR to protect nearby objects from overexposure in low light conditions. This dynamically adjusts the shutter speed and sensor gain. In addition, digital WDR is automatically activated to preserve details in dark areas.

**Adaptive IR:** With adaptive infrared (IR) technology, the power of the IR LED is dynamically adjusted to the changing light at night to avoid oversaturation in the scene.

Adaptive IR Level: When Adaptive IR is set to "OFF" you can drag the sliders to set the IR intensity manually.

## White Balance

The white balance is used to adjust the image material of a camera to the color temperature of the light at the shooting location.



## Basic Settings

**Mode:** Select one of these Modes:

**ATW:** ATW: "Auto Tracing White Balance" automatically controls the color temperature range.

**Auto:** This mode continuously adjusts the color balance of the camera to any change in color temperature.

**Manual:** In this mode, you can manually adjust the White Balance by adjusting red and blue color gain.

**R Gain:** Drag the slider to adjust the gain of red in the image.

**B Gain:** Drag the slider to adjust the gain of blue in the image.

**One Push:** Click on this button so that the camera automatically adjusts to the correct gain values.

## Basic Settings

In this section you can adjust the settings for image quality, color and image rotation.

Exposure	White Balance	Basic Setting
<b>Quality</b>		
Sharpness		50 (0~100)
3D Noise Reduction		20 (0~100)
Gamma Correction	<input type="text" value="0.45"/>	▼
<b>Color</b>		
Brightness		0 (-100~100)
Contrast		0 (-100~100)
Saturation		0 (-100~100)
Hue		0 (-100~100)
<b>Image Rotation</b>		
Orientation	<input type="text" value="Off"/>	▼

## Quality

**Sharpness:** Increase the sharpness value to sharpen the edges and details of the image. The value range is between 0 and 100.

**3D Noise Reduction:** You can reduce the image noise with this setting. The higher the value, the stronger the noise reduction effect. The value range is between 0 and 100.

**Gamma Correction:** Gamma correction may be required to correctly display the gray values of the camera image on a monitor. Select between 0.45 (standard) and 1.

## Color

**Brightness:** If you select a higher value, the image will be brighter. The value range is between -100 and 100.

**Contrast:** If you select a higher value, the image will be more contrasted. The value range is between -100 and 100.

**Saturation:** Reducing the color saturation brings the image closer to a grayscale image (monochrome). The selection of 100 offers the highest color saturation. The value range is between -100 and 100.

**Hue:** The hue value specifies the tone of the color. The value range is between -100 and 100.

## Image Rotation

**Orientation:** You can rotate the image according to your requirements.

**Off:** Default setting. The image is displayed as the camera sees it.

**Flip:** The image is mirrored around the horizontal axis.

**Mirror:** The image is mirrored around the vertical axis.

**Both:** The image is mirrored around the vertical and the horizontal axis.

## Lens Control

In this section you can adjust lens specific settings like zoom and focus.

The screenshot displays the 'Lens Control' configuration page. On the left is a navigation sidebar with options: Live View, Configuration, Advanced Configuration, Encode, Image, Lens Control (selected), Video, Network, System, Account, Event Source, Video Analytics, and Event Setting. The main content area is titled 'Lens Control' and contains several sections:

- Zoom Control:** A 'Manual' slider is shown with a value of 2.50 (range 1-3.0). The slider is positioned between 'Wide' and 'Tele'.
- Focus Control:** 'Autofocus' is selected. 'One-Push AF' has a 'Start' button. 'Manual' is selected. 'Focus Mode' is set to 'Normal'. An 'Absolute' slider is set to 10.86 (range 0-100), with 'Far' and 'Near' labels. 'Step Control' has '+' and '-' buttons.
- Advanced Focus Control:** 'Zoom Trigger' is set to 'On'.
- Restore Position:** A 'Start' button is present.

### Zoom Control

**Absolute:** By moving the slider, you can zoom in on distant objects (Tele), reducing the angle of view, or zoom out for a wide-angle view (Wide). The zoom-factor is between 1 and 3.0.

### Focus Control

**One-Push AF:** One-push auto focus (AF) is normally used on dome and bullet cameras with motorized lenses. The camera moves the lens during the auto focus process. Click on "Start" to focus the lens automatically and immediately.

**Focus Mode:** Two focus modes are available:

**Normal:** Select this mode, if you want to set a general focus distance.

**Advanced:** Select this mode, if you want to set different focus distances for day- and night mode.

**Absolute:** With the "Absolute" option, focus can be set according to the zoom settings. "Near" is generally suitable for the tele zoom, while "Far" is suitable for the wide-angle view.

**NOTE!** Absolute is only available in Focus Mode Normal.



**Day Position:** You can set a specific focus for the cameras Day-Mode according to the zoom settings. "Near" is generally suitable for the tele zoom, while "Far" is suitable for the wide-angle view.

**NOTE!** Day Position is only available in Focus Mode Advanced.

**Night Position:** You can set a specific focus for the cameras Night-Mode according to the zoom settings. "Near" is generally suitable for the tele zoom, while "Far" is suitable for the wide-angle view.

**NOTE!** Night Position is only available in Focus Mode Advanced.

**Step Control:**

## Advanced Focus Control

**Zoom Trigger:** When changing the ambient light intensity between day and night, the focus of the lens can be strongly influenced. Select "On" to automatically adjust the focus when switching from day to night mode or vice versa.

## Restore Position

**Start:** Click to reset the zoom and focus settings of the lens to the default settings.

## Video

In this section you can define Privacy and enhanced video codec settings.

The screenshot displays the 'Privacy Zone' configuration interface. It features two tabs: 'Privacy Zone' (active) and 'Enhanced Codec'. The 'Privacy Zone' tab contains a 'Basic Setting' section with a list of zones (Zone-1 to Zone-8) on the left and configuration options on the right. The options include 'Privacy Color Setting' (set to 'Black'), 'Enable' (radio buttons for 'On' and 'Off', with 'Off' selected), and 'Zone Setting' (with a 'Clean' button). A 'Save' button is located at the bottom right. To the right of the settings is a video preview window showing a cityscape with a building featuring a red heart logo.

## Privacy Zone

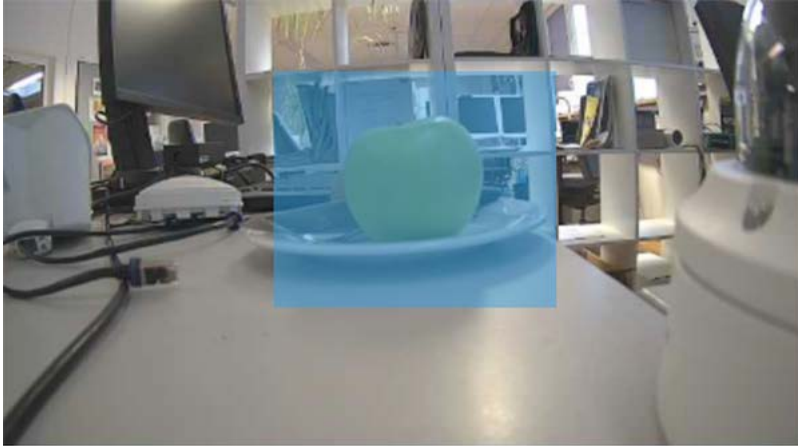

A privacy zone masks a defined image area to protect privacy. It applies to all streams, the recording and the live view and has no influence on analysis functions such as motion detection. You can define up to 8 different privacy zones. After setting up a privacy zone, a frame is displayed in the live view, the color, size and position of which can be adjusted.

### Basic Settings

This is how you set up a Privacy Zone:

1. Select one of the 8 zones.
2. Draw a rectangular Privacy Zone in the live image using the mouse.
3. Set the Zone options:
  - **Privacy Zone Color Options:** Select the color with which the zone is masked.
  - **Enable:** Switch the selected zone On or Off (default.)
  - **Zone Settings:** Click Clear to delete the settings of the selected zone.

### Enhanced Codec

Enhanced Codec is a method to ensure lower bit rates when selecting H.264/H.265.

Privacy Zone

Enhanced Codec

**Basic Setting**

Off

iZone

Zone 1 +

Level Mid ▾

Zone Save Clean

Zone 2 +

iStream

Level Mid ▾

Mode EcoZone ▾

Dynamic 3DNR Off ▾

## Basic Settings

**Off:** The Enhanced Codec is deactivated.

**iZone:** iZone is a function to allow different compression levels on different image areas while maintaining the target bit rate.

By activating this function, you can define a user-defined zone within the image that is compressed less. Image areas outside the zone are compressed more.

First, draw a rectangular Zone in the live image using the mouse, then make the following settings:

**Level:** A high level means higher image quality and lower compression in the zone.

**Zone:** Click Save to apply the settings. Click to delete the iZone.

## Configuration

### Configuration

**iStream:** This technology helps to efficiently save network bandwidth while maintaining the best possible image quality for critical image details. By activating this function, you can define a user-defined zone within the image that is compressed less. Image areas outside the zone are compressed more.

**NOTE!** If the "iStream" function is activated, further bit rate control functions are not available due to the dynamic bit rate management (see [H.264 / H.265, p. 34](#)).

First, draw a rectangular Zone in the live image using the mouse, then make the following settings:

**Level:** A high level means higher image quality and lower compression in the zone.

**Mode:** sad

**EcoZone:** Unlike iZone, EcoZone can identify dynamic motion within a scene faster and preserve its details in clear quality, while subjecting the remaining areas, such as static backgrounds, to a higher compression level, economically reducing bandwidth for less important things and preserving the dynamic motion details for further forensic purposes.

**EcoZone + EcoFrame:** This option increases the overall efficiency of the EcoZone mode.

**Dynamic 3DNR:** While 3DRN allows user to adjust noise reduction level manually, dynamic 3DRN dynamically and automatically adjusts to the best noise reduction level according to the amount of noise on the image. Lux level change is what triggers changes in noise reduction level for dynamic 3DNR. Higher lux activates smaller noise reduction level.

**NOTE!** Be aware that using Dynamic 3DNR in a scene that contains motion may result in blurred image.

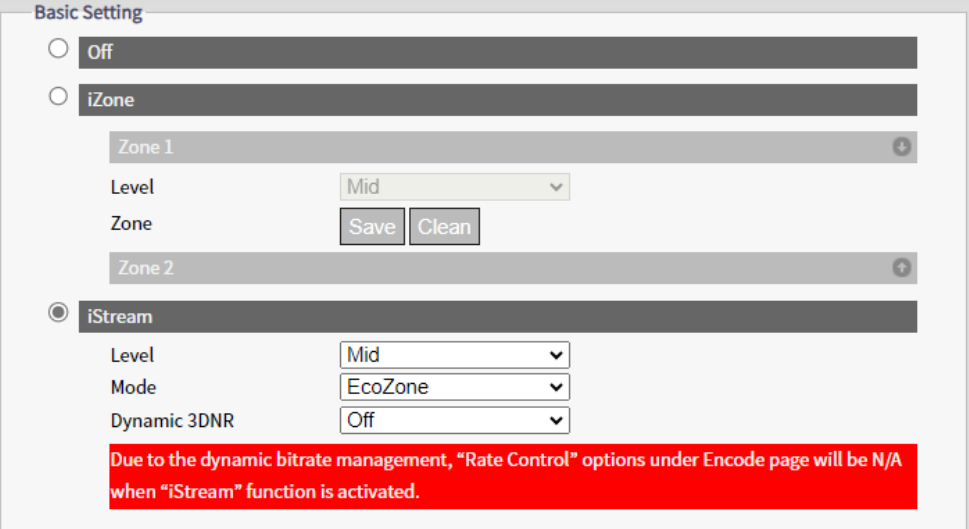

The screenshot shows the 'Basic Setting' configuration page. It features three radio buttons: 'Off', 'iZone', and 'iStream'. The 'iStream' option is selected. Under 'iZone', there are two zone configuration sections, 'Zone 1' and 'Zone 2', each with a 'Level' dropdown menu set to 'Mid' and 'Save'/'Clean' buttons. Under 'iStream', there are three dropdown menus: 'Level' (Mid), 'Mode' (EcoZone), and 'Dynamic 3DNR' (Off). A red warning box at the bottom of the configuration area states: "Due to the dynamic bitrate management, 'Rate Control' options under Encode page will be N/A when 'iStream' function is activated." Below the screenshot, a note reads: "NOTE! When Dynamic 3DNR function is 'ON' the 3DNR function under Images will become unavailable (see [Basic Settings, p. 38](#))." The word "NOTE!" is positioned to the left of the note, and "When" is positioned to the right.

# Network

In this section you can adjust network specific settings.

The screenshot shows a web-based configuration interface for a network device. The interface is divided into several sections:

- Navigation:** A top bar includes 'Live View', 'Configuration', a language dropdown set to 'English', and a user profile 'User-admin' with a 'Logout' link. Below this is a sub-menu with 'General', 'FTP Server', 'SFTP Server', 'RTSP', 'SNMP', '802.1X', 'Firewall', 'DDNS', and 'SSL'. A left sidebar under 'Advanced Configuration' lists 'Encode', 'Image', 'Video', 'Network' (highlighted), 'System', 'Account', 'Event Source', 'Video Analytics', and 'Event Setting'.
- Basic Setting:** Fields include 'Device Name' (Mx-VT1A-2-IR), 'HTTP Port' (80), 'Enable LDAP' (Off), 'Bonjour' (On), and 'WS Discovery' (Off). A 'View Current Network Settings' button is present.
- IP Settings:** Fields include 'Mode' (DHCP), 'APIPA' (Off), 'IPv4 Address' (192.168.178.138), 'IPv4 Subnet Mask' (255.255.255.0), 'IPv4 Default Gateway' (192.168.178.1), 'IPv6 Enable' (checkbox), 'Accept IPv6 router advertisements' (Off), 'Enable DHCPv6' (Off), 'IPv6 Address', 'Subnet prefix length' (1-128), 'IPv6 default router address', 'Subnet prefix length' (1-128), and 'IPv6 DNS'.
- Wired Setting:** 'Speed & Duplex' is set to 'Auto'.
- UPnP:** 'Enable UPnP' is 'On' and 'Mode' is 'IP and Device Name'.
- SSL:** 'Enable SSL' is 'Off'.

A 'Save' button is located at the bottom right of the configuration area.

## General

General
FTP Server
SFTP Server
RTSP
SNMP
802.1X
Firewall
DDNS
SSL

**Basic Setting**

Device Name

HTTP Port  (80, 1025-65535)

Enable LDAP  ▼

Bonjour  ▼

WS Discovery  ▼

View Current Network Settings [View](#)

**IP Settings**

Mode  ▼

APIPA  ▼

IPv4 Address

IPv4 Subnet Mask

IPv4 Default Gateway

IPv6 Enable

Accept IPv6 router advertisements  ▼

Enable DHCPv6  ▼

IPv6 Address

Subnet prefix length

IPv6 default router address

Subnet prefix length

IPv6 DNS

**Wired Setting**

Speed & Duplex  ▼

**UPnP**

Enable UPnP  ▼

Mode  ▼

**SSL**

Enable SSL  ▼

[Save](#)

## Basic Settings

**Basic Setting**

Device Name

HTTP Port  (80, 1025-65535)

Enable LDAP  ▼

Bonjour  ▼

WS Discovery  ▼

View Current Network Settings [View](#)

**Device Name:** The default name corresponds to the device type. You can change it if required.

**HTTP Port:** In general, the port does not need to be changed. If in doubt, please contact your administrator.

**Enable LDAP:** LDAP (Lightweight Directory Access Protocol) is a network protocol for querying and changing information from distributed directory services.

LDAP is an industry standard for authentication, authorization, address and user directories. Most software products that have to deal with user data and are relevant on the market support LDAP.

Please ask your administrator before enabling LDAP.

**Bonjour:** Bonjour, also known as Zero-Configuration Networking, enables the automatic detection of devices and services in a local network using industry-standard IP protocols. Bonjour is also used in Apple Safari, iTunes, AirPrint and some Adobe applications as well as network-enabled hardware. Please ask your administrator before activating Bonjour.

**WS Discovery:** WS-Discovery (Web Services Dynamic Discovery) is a technical specification that defines a multicast discovery protocol for finding services in a local network. It works over TCP and UDP port 3702 and uses the IP multicast address 239.255.255.250 or ff02::c. It can be used to search for ONVIF-enabled devices in a network. Please ask your administrator before activating WS-Discovery.

**View Current Network Settings:** Click to display your current network related settings.

**Basic Setting**

**Network Interface Information**

```
eth0  Link encap:Ethernet  HWaddr 00:03:C5:C3:00:14
      inet addr:192.168.178.138  Bcast:192.168.178.255
      Mask:255.255.255.0
```

IPv6 Address

IPv6 DNS

## IP Settings

**IP Settings**

Mode	<input type="text" value="DHCP"/>
APIPA	<input type="text" value="Off"/>
IPv4 Address	<input type="text" value="192.168.178.138"/>
IPv4 Subnet Mask	<input type="text" value="255.255.255.0"/>
IPv4 Default Gateway	<input type="text" value="192.168.178.1"/>
IPv6 Enable	<input type="checkbox"/>
Accept IPv6 router advertisements	<input type="text" value="Off"/>
Enable DHCPv6	<input type="text" value="Off"/>
IPv6 Address	<input type="text"/>
Subnet prefix length	<input type="text" value="(1-128)"/>
IPv6 default router address	<input type="text"/>
Subnet prefix length	<input type="text" value="(1-128)"/>
IPv6 DNS	<input type="text"/>

## Configuration

### Configuration

---

**Mode:** Select:from the following network modes:

**Manual:** Enter a fixed IP address and the corresponding settings.

**IPv4 Address:** Enter a fixed IPv4 address.

**IPv4 Subnet Mask:** Enter the subnet mask according to your network configuration (usually 255.255.255.0).

**IPv4 Default Gateway:** Enter the gateways IP address according to your network configuration (usually the routers default IP address).

**Primary DNS:** Enter the primary DNS (Domain Name System Server) address according to your network configuration (usually the routers default IP address).

**Secondary DNS:** Enter the secondary DNS address according to your network configuration (usually the routers default IP address).

**PPPoE:** It is a point-to-point protocol that provides authentication, encryption and compression. It authenticates the user primarily with a predefined user name and password.

**DHCP:**The camera will automatically obtain an available dynamic IP address from the DHCP server each time it connects to the LAN.

**APIPA:** APIPA (Automatic Private IP Addressing) helps to reserve a specific address block for link-local addressing if DHCP is not available in the connected Internet environment.

**IPv6 Enable:** Enable/ Disable IPv6 protocol.

**Accept IPv6 router advertisements:** Check to activate RA (Router Advertisement). A router advertisement message is regularly issued by a router or in response to a router solicitation message from a host. These router advertisements inform a client whether it receives an IP address from a DHCPv6 server or assigns one itself.

**Enable DHCPv6:** If this option is activated, the camera automatically obtains an available dynamic IP address under the IPv6 protocol from the DHCP server each time it connects to the LAN.

**IPv6 Address:** Enter a fixed IPv6 address.

**Subnet prefix length:** When DHCPv6 is Off, set prefix length for subnet. The range is between 1 and 128.

**IPv6 default router address:** Enter the routers IPv6 address according to your network configuration.

**Subnet prefix length:** When DHCPv6 is Off, set prefix length for subnet. The range is between 1 and 128.

**IPv6 DNS:** Enter the primary DNS (Domain Name System Server) address according to your network configuration (usually the routers default IPv6 address).

## Wired Settings

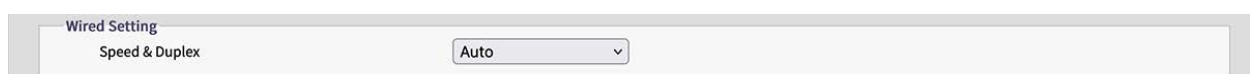

The image shows a screenshot of a configuration interface. At the top, it says "Wired Setting". Below that, there is a label "Speed & Duplex" and a dropdown menu. The dropdown menu is currently set to "Auto".



**Speed & Duplex:** Select according to your network environment. Due to possible data collisions, half-duplex can only send or receive data simultaneously, while full-duplex is able to receive and send data simultaneously at full line speed without collisions occurring. The following applies to the selected data rate ( Mbit/s): The higher the rate, the faster data can be transmitted. With the "Auto" setting, the camera automatically decides which mode to use.

## UPnP

The image shows a configuration panel for UPnP. It has a title 'UPnP' in the top left. Below the title, there are two rows of settings. The first row is 'Enable UPnP' with a dropdown menu set to 'On'. The second row is 'Mode' with a dropdown menu set to 'IP and Device Name'.

**Enable UPnP:** If the UPnP function (Universal Plug & Play) is activated, the camera can be recognized by UPnP-capable devices in the network.

**IP and Device Name:** The device name and IP address will be visible for other network devices.

**Device Name:** Only device name will be visible.

**User Input:** You can provide a customized name for the camera to be visible for other network devices.

## SSL

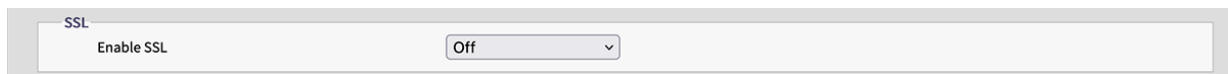
The image shows a configuration panel for SSL. It has a title 'SSL' in the top left. Below the title, there is one row of settings: 'Enable SSL' with a dropdown menu set to 'Off'.

**SSL:** Enable the use of SSL (Secure Sockets Layer) to set up secure communication for both HTTP and HTTPS

**NOTE!** "HTTPS only" only works within an HTTPS connection.

## FTP Server

This section describes how to use the camera as an FTP server.

FTP (File Transfer Protocol) is a standard Internet protocol that enables the transfer of files between two computers via a TCP-based network.

In contrast to SFTP (see [SFTP Server, p. 50](#)), communication with FTP is unencrypted.

The camera can function both as an FTP server and as an FTP client.

As long as the FTP server is enabled, users can use an FTP client to access the files (video/image recordings) stored on the camera's SD card.

The login details correspond to the user account. A maximum of 30 simultaneous connections to the FTP server is possible.

**EXAMPLE:** To access the data stored on the SD card via FTP using a web browser, enter e.g. ftp://<login ID>:<password>@<IP address> (e.g. ftp://admin:1234@192.168.0.30.) in the browser search field.

General **FTP Server** SFTP Server RTSP SNMP 802.1X Firewall DDNS SSL

Basic Setting

Enable

Port  (21, 1025-65535)

Save

## Basic Settings

**Enable:** Enable or disable the FTP server.

**Port:** In general, the port (default: 21) does not need to be changed. If in doubt, please contact your administrator.

## SFTP Server

This section describes how to use the camera as an SFTP server.

SFTP (Secure File Transfer Protocol) is an Internet protocol that enables the transfer of files between two computers via a TCP-based network. In contrast to FTP (see [FTP Server, p. 49](#)), communication with SFTP is encrypted. The camera can act both as an SFTP server and as an SFTP client.

As long as the SFTP server is activated, users can use an SFTP client to access the files (video/image recordings) stored on the camera's SD card.

The login data corresponds to the user account. A maximum of 30 simultaneous connections to the SFTP server are possible.

**EXAMPLE:** To access the data stored on the SD card via FTP using a web browser, enter e.g. ftp://<login ID>:<password>@<IP address> (e.g. ftp://admin:1234@192.168.0.30.) in the browser search field.

General FTP Server **SFTP Server** RTSP SNMP 802.1X Firewall DDNS SSL

Basic Setting

Enable

Port  (1025-65535)

Save

## Basic Settings

**Enable:** Enable or disable the SFTP server.

**Port:** In general, the port (default: 2221) does not need to be changed. If in doubt, please contact your administrator.

## RTSP

This section describes how to configure an RTSP connection.

RTSP (Realtime Streaming Protocol) is a standard protocol for connecting a client to set up and control data streams over the Internet.

If you want to allow third-party devices or software to access video/audio streams from the IP camera over the network, you need to configure the RTSP ports.

The main difference between unicast and multicast is the way in which the client and server communicate packets with each other.

A unicast transmission is a direct one-to-one communication between the camera and the client application. In a multicast system, on the other hand, this is referred to as one-to-many communication.

Unicast requires more network bandwidth than multicast, but is easier to configure and generally more stable due to its simple structure.

Multicast, on the other hand, requires less bandwidth and resources and is more practical for transmission to multiple devices, provided that all relevant peripheral devices such as switches or routers support the multicast protocol.

Different IP addresses for video, audio and metadata can be configured for each RTSP session. If codec related information is changed, the RTSP server will be restarted.

General	FTP Server	SFTP Server	RTSP	SNMP	802.1X	Firewall	DDNS	SSL	
<b>Basic Setting</b>									
Authentication			Off	Port					554 (554,1025-65535)
Multicast Auto Connection			Off						
<b>Stream1</b>									
URL			stream1	Metadata			Off		
<b>Multicast Address Setting</b>									
Address Type			Auto	Multicast URL			stream1m		
Video Address			239.195.0.112	Video Port			5846 (1025-65535, even number)		
Audio Address			239.195.0.112	Audio Port			3380 (1025-65535, even number)		
Meta Address			239.195.0.112	Meta Port			4726 (1025-65535, even number)		
<b>Stream2</b>									
URL			stream2	Metadata			Off		
<b>Multicast Address Setting</b>									
Address Type			Auto	Multicast URL			stream2m		
Video Address			239.195.0.112	Video Port			3012 (1025-65535, even number)		
Audio Address			239.195.0.112	Audio Port			2916 (1025-65535, even number)		
Meta Address			239.195.0.112	Meta Port			5262 (1025-65535, even number)		
<b>Stream3</b>									
URL			stream3	Metadata			Off		
<b>Multicast Address Setting</b>									
Address Type			Auto	Multicast URL			stream3m		
Video Address			239.195.0.112	Video Port			3956 (1025-65535, even number)		
Audio Address			239.195.0.112	Audio Port			2736 (1025-65535, even number)		
Meta Address			239.195.0.112	Meta Port			3204 (1025-65535, even number)		

## Basic Settings

**Authentication:** Set the authentication to "On" to secure the RTSP connection process.

**NOTE!** If authentication is enabled, the user name and password must be entered on the client.

**Port:** Enter the RTSP Port

**Multicast Auto Connection:** If you set Auto Connect to "ON", the automatic connection via multicast mode is activated.

## Stream

You can configure up to 3 RTSP streams. Each stream can be configured individually.

**URL:** Enter an individual name for the unicast stream. The name is part of the URL via which the stream can be accessed.

**EXAMPLE:** Suppose the name of the stream is "stream1", the URL could look like this:

```
rtsp://192.168.0.30:1554/stream1
```

**Metadata:** Set to "ON" if meta data should be transmitted with the stream.

**Multicast Auto Connection:** If you set Auto Connect to "ON", the automatic connection via multicast mode is activated.

**Multicast URL:** Enter an individual name for the multicast stream. The name is part of the URL via which the stream can be accessed.

**EXAMPLE:** Suppose the name of the multicast stream is "stream1m", the URL could look like this:

```
rtsp://192.168.0.30:1554/stream1m
```

**Address Type:** Select "Manual" to manually set the IP addresses and ports for retrieving video, audio and meta settings. The "Auto" option (default) offers the default IP address and the default ports of the camera.

**Video Adress:** If Adress Type is set to "Manual" you can edit the IP-Adress for streaming video data.

**Audio Adress:** If Adress Type is set to "Manual" you can edit the IP-Adress for streaming audio data.

**Metadata Adress:** If Adress Type is set to "Manual" you can edit the IP-Adress for streaming meta data.

**Video Port:** If Adress Type is set to "Manual" you can edit the port for streaming video data.

**Audio Port:** If Adress Type is set to "Manual" you can edit the port for streaming audio data.

**Metadata Port:** If Adress Type is set to "Manual" you can edit the port for streaming meta data.

## SNMP

It is possible to send SNMP v1, v2 and v3 traps

SNMP (Simple Network Management Protocol) is a widely used protocol for monitoring network devices. Messages are sent to a management host or a trap receiver.

General FTP Server SFTP Server RTSP **SNMP** 802.1X Firewall DDNS SSL

**SNMP v1**  
 Enable

**SNMP v2c**  
 Enable   
 Read Community String   
 Write Community String   
 Trap Community String

**SNMP v3**  
 Enable   
 Authentication Mode   
 Privacy Mode   
 User Name   
 Authentication Password   
 Privacy Password

**Trap**  
 Mode   
 Heartbeat   
 Event   
 Target IP   
 Heartbeat Interval  (5-600)

**Download MIB**

### SNMP v1

**SNMP v1**  
 Enable

**Enable:** Select “On” or “Off” (default) to enable or disable.

### SNMP v2c

**SNMP v2c**  
 Enable   
 Read Community String   
 Write Community String   
 Trap Community String

**Enable:** Select “On” or “Off” (default) to enable or disable.

The “SNMP community string” is like a user ID or password that allows access to a router's or other device's statistics.

**NOTE!** The read-only community string must be different to the read-write community string.

**Read Community String:** Enter a write community string.

**Write Community String:** Enter a write community string.

**Trap Community String:** Enter a community string for SNMP traps.

### SNMP v3

**SNMP v3**  
 Enable   
 Authentication Mode   
 Privacy Mode   
 User Name   
 Authentication Password   
 Privacy Password

## Configuration

### Configuration

---

SNMP V3 provides more security features than SNMP v1/SNMP v2.

**Enable:** Select “On” or “Off” (default) to enable or disable.

**User Name:** Enter the user name for SNMP v3.

**Authentication Mode:** Available modes are: None (default), MD5, SHA.

**Authentication Password:** If a Authentication Mode is selected enter a password for the user authentication.

**Privacy Mode:** Select a Privacy Mode to encrypt the data Privacy Password. Available modes are AES and DES.

**Privacy Password:** If a Privacy Mode is selected enter a password for data privacy.

## Trap

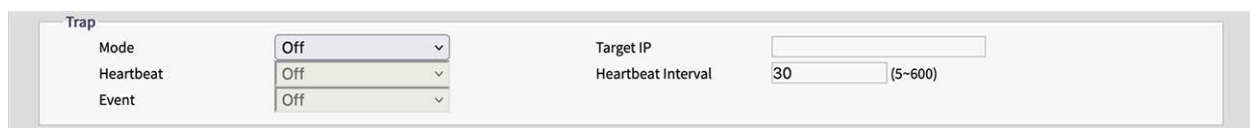

The image shows a configuration panel for SNMP Traps. It contains the following fields:

Trap	
Mode	Off
Heartbeat	Off
Event	Off
Target IP	<input type="text"/>
Heartbeat Interval	30 (5-600)

You can connect a SNMP Trap receiver here.

**Mode:** Select the Version of the SNMP protocol to be used.

**Target IP:** Enter the SNPM clients IP-Adress.

**Heartbeat:** Set to "On" if a periodic heartbeat trap should be sent.

**Heartbeat Interval:** Enter the interval (in seconds) for the periodic heartbeat.

**Event:** Set to "On" if traps should be sent on camera events.

## Download MIB

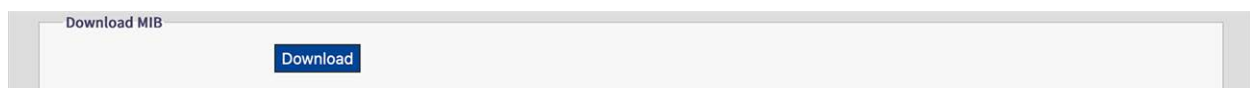

The image shows a button labeled "Download MIB" with a "Download" button next to it.

**DOWNLOAD:** Click to download details of the MIB (Management Information Base) as a.MY file.

**NOTE!** MIBs describe the structure of the management data of a device subsystem that uses a hierarchical name space with object identifiers (OID). Each OID identifies a variable that can be read or set via SNMP.

## 802.1X

The screenshot shows the configuration page for 802.1X. The 'Basic Setting' section includes the following fields:

- Protocol:** A dropdown menu set to 'EAP-TTLS'.
- Inner Authentication:** A dropdown menu set to 'CHAP'.
- User Name:** A text input field containing 'mrX'.
- Password:** A text input field with masked characters '\*\*\*'.
- Anonymous ID:** A text input field with masked characters '\*\*\*\*\*'.
- Status:** A checkbox that is currently unchecked.
- CA Certificate:** A button labeled 'Choose File'.

A 'Save and Test' button is located at the bottom right of the configuration area.

IEEE 802.1X is a standard for authentication in computer networks and defines the encapsulation of the Extensible Authentication Protocol (EAP) via IEEE 802.

### Basic Settings

**Protocol:** Select the EAP protocol type and enter the required data to complete the setup.

**EAP-MD5:** This is the only EAP method based on IETF standards and offers the lowest security.

**User Name:** Enter The User Name.

**Password:** Enter the Password.

**EAP-TTLS:** EAP-TTLS (Tunneled Transport Layer Security) is widely supported among wireless vendors.

**Inner Authentication:** The internal authentication mode can support CHAP, EAP-MSCHAPV2, MD5, MSCHAP, MSCHAPV2 and PA.

**User Name:** Enter The User Name.

**Password:** Enter the Password.

**Anonymous ID:** Enter the anonymous ID.

**CA Certificate:** Select a certificate issued by a certificate authority (CA).

**EAP-PEAP:** The Protected Extensible Authentication Protocol (PEAP) was developed jointly by Cisco Systems, Microsoft and RSA Security and offers unique security.

**User Name:** Enter The User Name.

**Password:** Enter the Password.

### Firewall

You can manually define several IP addresses to be allowed or denied to access camera

Filter	Enable	IP Address
1	<input type="checkbox"/>	
2	<input type="checkbox"/>	
3	<input type="checkbox"/>	
4	<input type="checkbox"/>	
5	<input type="checkbox"/>	
6	<input type="checkbox"/>	
7	<input type="checkbox"/>	
8	<input type="checkbox"/>	
9	<input type="checkbox"/>	
10	<input type="checkbox"/>	

## Basic Settings

**Mode:** Select a firewall mode:

**Off** This is the default setting. No specific IP addresses are allowed or denied.

**Allow:** You can define IP addresses that are explicitly allowed to access the camera.

**Deny:** You can define IP addresses that are explicitly not allowed to access the camera.

## DDNS

Dynamic Domain Name Server (DDNS) is a system that can update DSN records automatically and in real time without the need for further manual editing, resulting in faster and smoother web address routing.

Enable	On
Type	DynDNS
Hostname	
User Name	
Password	

## Basic Settings

**Enable:** Select "On" to activate the configured DNS Service. There are 4 types of DDNS available:

**DynDNS** A leading DDNS provider with fee-based offers.

**No-IP:** A DDNS provider with free offers. Registration required.

**Two-DNS:** A DDNS provider with free offers. Registration required.

**FreeDNS:** A DDNS provider with free offers. Registration required.

**Hostname:** Enter the host name for DDNS.

**User Name:** Enter a user name for accessing the DDNS.

**Password:** Enter the password for accessing the DDNS.



## SSL

Secure Sockets Layer (SSL) is the standard security technology for encryption. It enables the secure transmission of sensitive information such as login data.

General FTP Server SFTP Server RTSP SNMP 802.1X Firewall DDNS **SSL**

**Generate Certificate**

Method

**Certificate Area**

Country Code <input type="text"/>	Organization Name <input type="text"/>
<small>2-letter country code, e.g; US</small>	<small>e.g; Your company name.</small>
Province Name <input type="text"/>	Organization Unit Name <input type="text"/>
<small>Full name of your state or province.</small>	<small>e.g; Your department or section.</small>
City Name <input type="text"/>	Email Address <input type="text"/>
Common Name <input type="text"/>	
<small>Hostname or IP address of this device.</small>	

## Generate Certificate

**Method:** Select "On" to activate the configured DNS Service. There are 4 types of DDNS available:

**None:** No SSL certificate is used(default).

**Self-Signed:** A self-signed certificate is a private, proprietary key that has no connection to a person or organization that performs an authorized certificate signing procedure. For a self-signed certificate, the user can create a CSR (Certificate Signing Request) by filling in the following information.

**Country Code:** Enter two-letter country code.

**Organization Name:** Enter e.g. your company name.

**Province Name:** Full name of your state or province.

**Organization Unit Name:** Enter e.g. your department or section.

**City Name:** Enter your city name.

Email Address: Enter your contact email address.

**Common Name:** Enter the Hostname or IP address of this device.

**Generate Certificate:** Click to generate the self signed SSL certificate and show the certificate information.

**Request:** A DDNS provider with free offers. Registration required.

**Country Code:** Enter two-letter country code.

**Organization Name:** Enter e.g. your company name.

**Province Name:** Full name of your state or province.

**Organization Unit Name:** Enter e.g. your department or section.

**City Name:** Enter your city name.

Email Address: Enter your contact email address.

**Common Name:** Enter the Hostname or IP address of this device.

**Upload Certificate:** A DDNS provider with free offers. Registration required.

**Upload Certificate:** Click to load the certificate file that you received from the DDNS provider onto the camera.

**CA Certificate:** Click to load the CA (Certificate Authority), which is issued by authorized person or organization onto the camera.

## Certificate Information

The certificate information is displayed when a certificate has been generated or uploaded.

Certificate Information			
Common Name	mobotix		
Organization	MOBOTIX	Country	DE
Locality	Langmail,Pfalz	Issuer	MOBOTIX
Valid from	Jan 15 18:30:25 1970 GMT	To	Jan 15 18:30:25 1971 GMT

[Delete Certificate](#)

▪ **Delete Certificate:**

Click to delete a certificate.

## System

In this section you can adjust system specific settings.

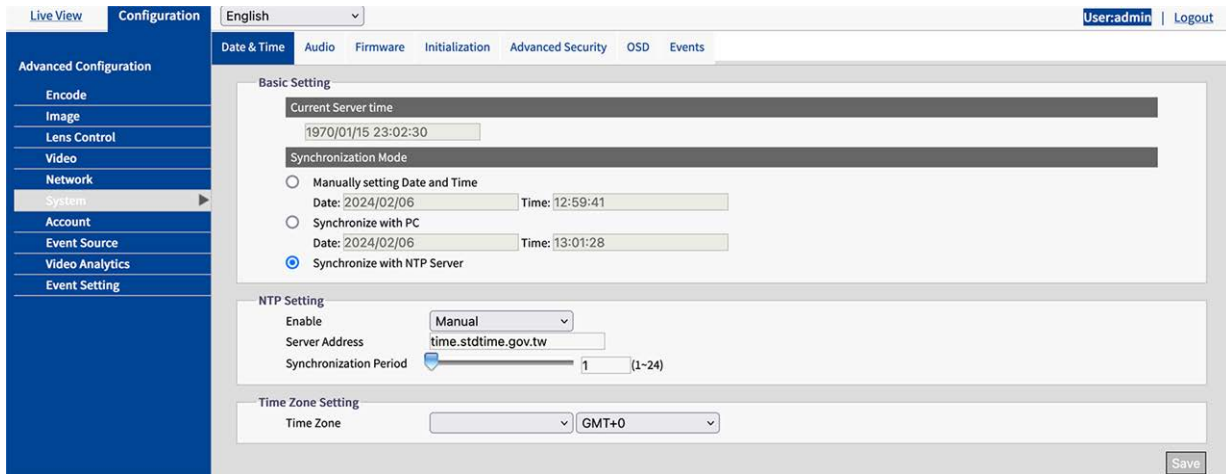

## Date & Time

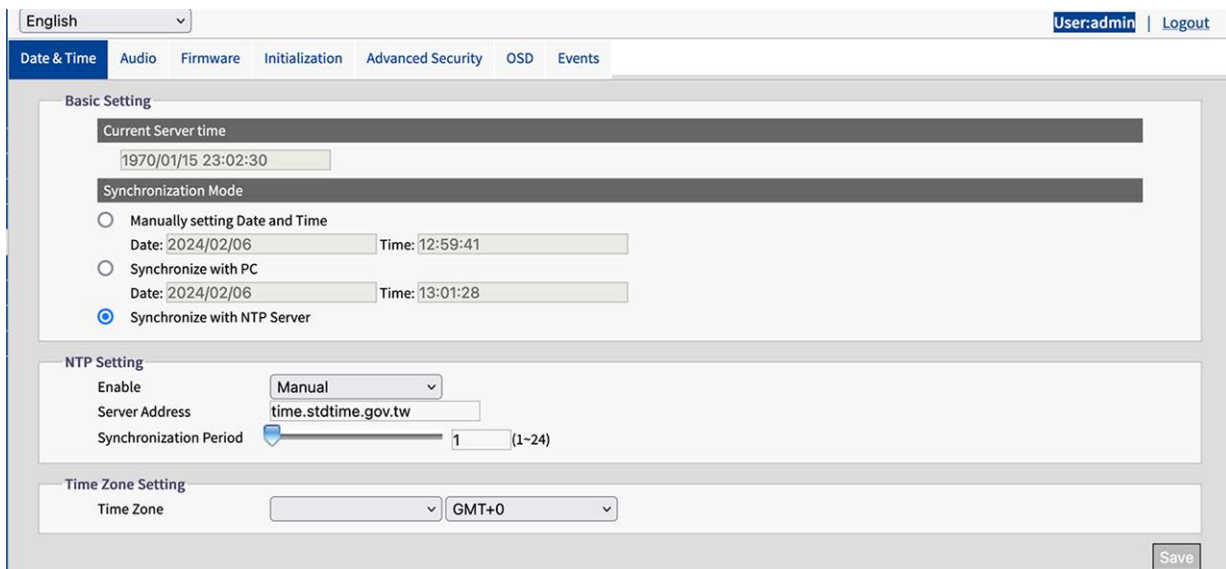

## Basic Settings

**Current Server Time:** The current date/time is displayed here

### Synchronization Mode:

**Manually setting Date and Time:** Set the current date and time manually.

**Synchronize with PC:** Select this option to synchronize date and time of the camera with PC time.

**Synchronize with NTP Server:** Select this option to synchronize date and time of the camera with date and time of the assigned NTP server.

## NTP Settings

### Enable:

**Manual:** Set the time server address manually.

**From DHCP Server:** Enter the IP Address of the DHCP server which provides the time via NTP.

**Synchronize with NTP Server:** Select this option to synchronize date and time of the camera with date and time of the assigned NTP server.

**Synchronization Period:** Enter a time interval at which the camera should synchronize with the time server.

## Time Zone Setting

**Time Zone:** Select the time zone to which you want to assign the camera.

## Audio

The camera is equipped with a built-in microphone for audio input.

Setting	Value
Source	Mic In
Enable	On
Encoding	G.711 μ-law
Level	Mid

## Audio In Setting

**Source:** Select the internal microphone.

**Enable:** Select "On" (default), to activate the microphone.

**Encoding:** Select the audio codec according to your needs:

**G.711 a-law:** G.711a (a-law) is primarily used in Europe.

**G.711 μ-law:** this codec is primarily used in the USA.

**Level:** Low, Mid and High, are selectable levels for audio input.

## Firmware

Date & Time	Audio	Firmware	Initialization	Advanced Security	OSD	Events
System Information						
Firmware Version	mb20231019TU					
Hardware Version	00.00					
Product Name	Mx-VT1A-203-IR					
Serial Number	T32450400					
MAC Address	00:03:c5:c3:00:70					
Firmware Upload						
<input type="button" value="Choose File"/> <input type="button" value="Upgrade"/>						

### System Information

This section shows detailed information about the installed camera firmware.

### Firmware Upload

You can update the system firmware manually.

During the firmware upgrade, the camera will be unavailable for about 3 minutes.

**CAUTION!** Never disconnect the power supply or LAN cable during the upgrade process.

- Click "Choose File" to select a corresponding firmware file, the click "Upgrade" to continue.

## Initialization

Date & Time	Audio	Firmware	Initialization	Advanced Security	OSD	Events
System Information						
Firmware Version	mb20231019TU					
Hardware Version	00.00					
Product Name	Mx-VT1A-203-IR					
Serial Number	T32450400					
MAC Address	00:03:c5:c3:00:70					
Firmware Upload						
<input type="button" value="Choose File"/> <input type="button" value="Upgrade"/>						

### System Frequency

Select between 50Hz and 60Hz (default). Once set to the correct frequency, Flickering by fluorescent light can be reduced.

### Import Setting

You can import camera settings.

Click on "Choose File" to select a to select a file with previously exported settings then click on "Import".

### Export Setting

Click on “Export” to download configuration settings to your local computer.

### Configuration Setting

**Reboot:** Click to reboot the camera

**Software Factory Default:** Click to reset all configuration back to factory defaults excluding network settings.

**Hardware Factory Default:** Click to reset it to reset all settings to factory defaults.

### Advanced Security

**Active Prevention**

SSH	Off	SNMP	Off
FTP	Off	SFTP	Off
WS-Discovery	Off	IP Finder	Off
UPNP	Off	Avahi	Off

**Passive Protection**

Enable: Off

SSH: Off

Period: 1 (1-10 Minutes)

Ban: 5 (Minutes)

Email: Off

Frequency: 5 (1-10)

FTP: Off

SFTP: Off

Port Scan: Off

File Manipulation: Off

**Email**

Authentication: No\_Auth

Server Address: [Text Field]

User Name: [Text Field]

Email Address: 1

Off

Sender Email Address: [Text Field]

Port: [Text Field]

Password: [Text Field]

**Banned IP List**

No.	Action	Time	IP Address
[Empty Row]			

Reset Select All

### Active Prevention

When switched to "ON" the system will disable the SSH, FTP, WS-Discovery, UPNP, SNMP, SFTP, IP Finder, Avahi connection port.

**Reboot:** Click to reboot the camera

**Software Factory Default:** Click to reset all configuration back to factory defaults excluding network settings.

**Hardware Factory Default:** Click to reset it to reset all settings to factory defaults.

### Passive Protection

You can manually set the time period, frequency and system actions when incorrect login data is entered.

## Email

You can configure email addresses to be notified of suspicious actions.

## Banned IP List

You can manage IP addresses banned by the system.

## OSD

In this area, you can activate the OSD (On Screen Display) settings. You can configure 3 areas in which information can be displayed above the camera image, such as the date, any text or event data

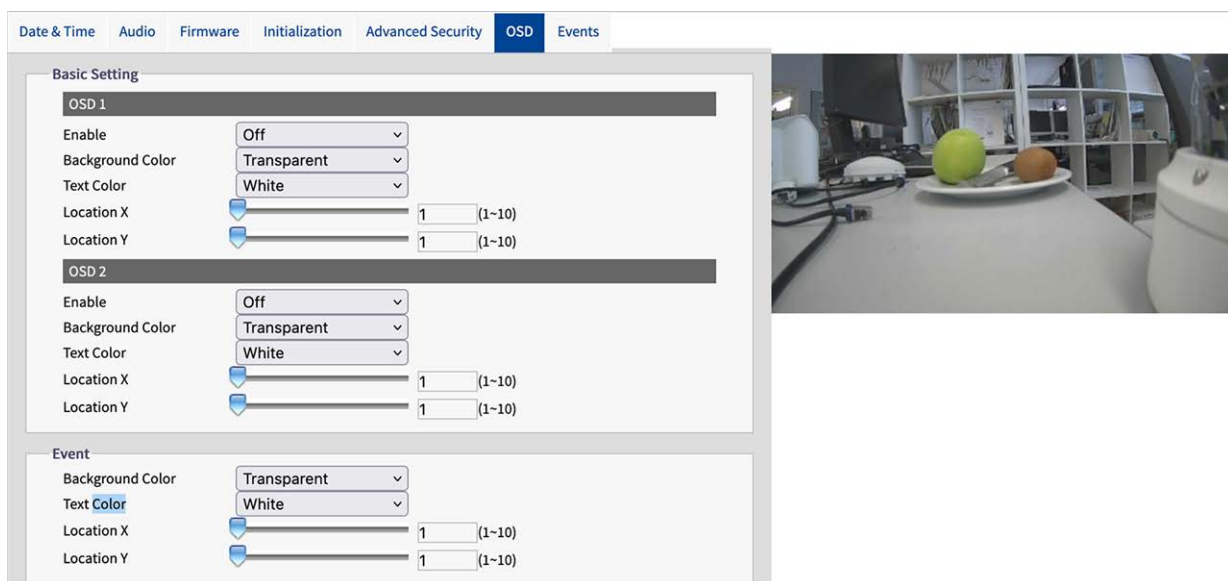

### Basic Setting

You can configure two areas (OSD 1, OSD 2) to display additional information on the camera image.

**Enable:** Select, which information is to be displayed

**Background Color:** Select the background color for the OSD.

**Text Color:** Select the text color for the OSD.

**Location X, Y:** Drag the sliders to set the position of the OSD.

### Event

You can configure an OSD to display event information on the camera image.

**Background Color:** Select the background color for the OSD.

**Text Color:** Select the text color for the OSD.

**Location X, Y:** Drag the sliders to set the position of the OSD.

## Events

The camera detects a variety of events such as motion, tampering, network loss, alarm. In this area, you can search for specific event types and filter them specifically.

The screenshot shows the 'Events' configuration page. At the top, there are navigation tabs: Date & Time, Audio, Firmware, Initialization, Advanced Security, OSD, and Events. The 'Events' tab is active. Below the tabs is a 'Basic Setting' section. On the left is an 'Event List' table with columns for No., Event Type, Start Time, and End Time. The table contains five rows of motion events. On the right is a 'Filter' section with 'Event Type' checkboxes for Tamper, Network Loss, Line Counting, Defocus, Motion, Schedule, and Border Line. Below that is a 'Time' section with radio buttons for 'All the time' (selected) and 'Manual', and input fields for 'Start Time' and 'End Time'. A 'Search' button is located below the time fields. At the bottom right is an 'Analysis' section showing a legend of event types and their counts: Motion:5, Tamper:0, Audio:0, Defocus:0, Schedule:0, Network Loss:0, Border Lines:0, and Line Counting:0. At the bottom of the main content area are 'Clean Up' and 'Refresh' buttons.

No.	Event Type	Start Time	End Time
1	motion	1970/01/16 18:52:14	1970/01/16 18:52:16
2	motion	1970/01/16 18:52:48	1970/01/16 18:52:50
3	motion	1970/01/16 18:53:09	1970/01/16 18:53:11
4	motion	1970/01/16 18:53:11	1970/01/16 18:53:12
5	motion	1970/01/16 18:53:20	1970/01/16 18:53:22

### Event List

The Event List shows all events according to the set filter or time range.

**Clean Up:** Click to delete all events.

**Refresh:** Click to load all events according to the set filter or time.

### Filter

**Event Type:** Select the events to be displayed in the Event List

**Time:** Specify the time range from which the events are to be displayed in the Event List.

**Analysis:** This area shows the number of times the specific event types occurred according to the set filter or time range.

## Account

In this section you can manage user accounts.



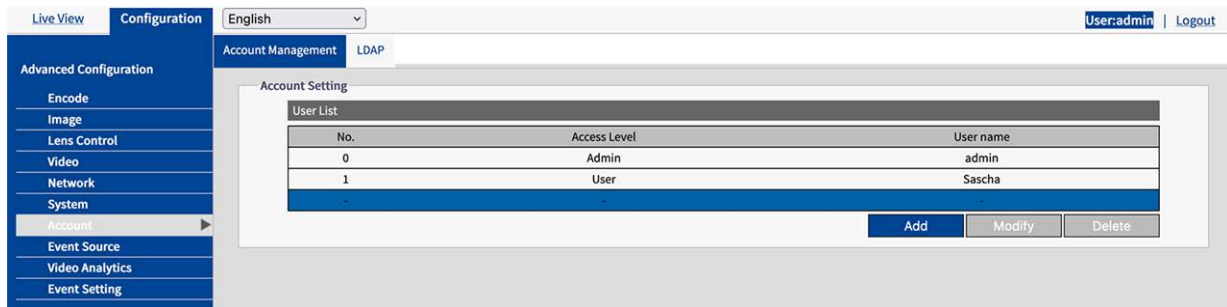

## Account Management

Up to 10 users with different roles can be added to the camera.

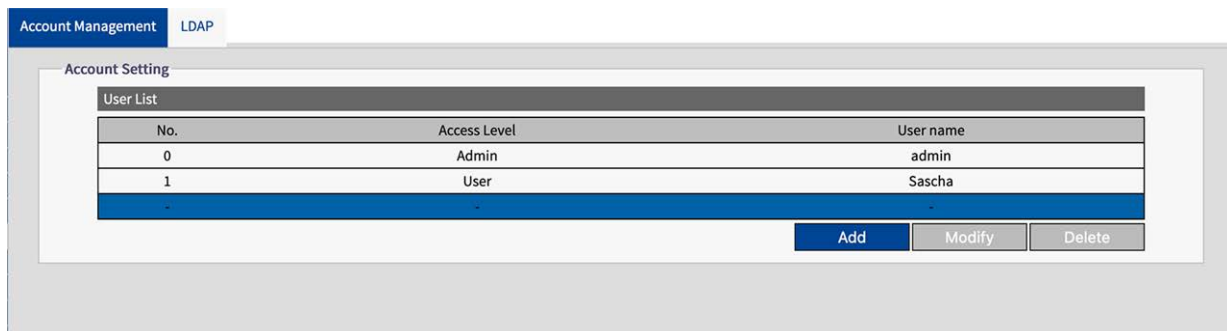

**Add:** Click to add a user.

**Account Setting**

Access Level       Admin    Operator    User

User Name       

Password

**Account Setting:** Specify the Access Level, User Name and Password.

**NOTE!** The password must be at least 10 characters long and contain 1 capital letter, 1 special character and alphanumeric characters.

The Access Levels are:

**Admin:** The "Admin" level has the highest access rights to the camera and can fully manage both the live view and all configuration settings.

**Operator:** An "Operator" can access the camera to use the live view, storage and remote control of the lens.

**User:** The "User" level is the lowest level and can only access the camera to use the live view.

## LDAP

LDAP (Lightweight Directory Access Protocol) is a network protocol for querying and changing information from distributed directory services.

LDAP is an industry standard for authentication, authorization, address and user directories. Most software products that have to deal with user data and are relevant on the market support LDAP.

The screenshot shows a web-based configuration interface for LDAP. At the top, there are two tabs: 'Account Management' and 'LDAP'. The 'LDAP' tab is selected. The interface is divided into three main sections: 'Basic Setting', 'Group Mappings', and 'Authentication'. Each section contains several input fields and a 'Submit' button.

Section	Field	Value
Basic Setting	Server	
	Port	389 (389, 1025-65535)
	Base DN	dc=ipcamera,dc=com
	Bind DN Template	uid=%u,dc=users,dc=ipcamera,dc=com
	Search Template	cn=%u
Group Mappings	Admins	cn=admin,dc=groups,dc=ipcamera,dc=com
	Operators	cn=operator,dc=groups,dc=ipcamera,dc=com
	Users	cn=user,dc=groups,dc=ipcamera,dc=com
Authentication	User Name	
	Password	
	Enable TLS	Off

Buttons: Delete, Choose File, Submit

### Basic Setting

**Server:** Enter a LDAP Server Address.

**Port** Enter the Port for the LDAP Server. It is recommended to use the default port number 389. If it is necessary to change the port number, please contact your system administrator.

**Base DN:** The strings for Base DN (Distinguish Name) are updated by the LDAP server to be accessed.

**Bind DN Template:** The strings for Bind DN Template (sublevel of Base DN) are updated by the LDAP server to be accessed.

**Search Template:** The strings for Search Template (are updated by the LDAP server to be accessed.

### Group Mappings

**Admins:** refer to the rights of the LDAP administrator and has the highest access rights to the camera and can fully manage both the live view and all configuration settings.

**Operators** refer to the rights of the LDAP operator and can access the camera to use the live view, storage and remote control of the lens.

**Users:** refer to the rights of the LDAP user and can only access the camera to use the live view.

### Authentication

**User Name:** Enter a user name for authentication at the LDAP service.

**Password:** Enter the password corresponding to the user name for authentication at the LDAP ser-

vice.

**TLS:** You can select and submit certification file for authentication at the LDAP service.

## Event Source

The following event sources are available: Audio, Defocus, Motion, Network, Schedule, Tamper.

The configuration options of the event sources essentially consist of the event-specific options, the event handlers and the activation schedule. The following table provides an overview of the event source configurations and their dependencies

The screenshot displays the configuration page for the 'Audio' event source. The 'Basic Setting' section includes a 'Sound Intensity Threshold' with an 'Enable' checkbox and a slider set to 50. The 'Handlers' section is divided into 'Snapshot' (with 'Store to Edge' and 'Store to FTP' checkboxes) and 'Recording' (with 'Edge Record' checkbox). Below these are sections for 'Email' (with 'Enable', 'Subject', and 'Message' fields), 'OSD' (with 'Enable' checkbox and 'Text' field), and 'HTTP Generic Event' (with 'Enable' checkbox and 'Method' dropdown). At the bottom is an 'Arming Schedule Setting' table with columns for days of the week and hours (0-24), showing a schedule of blue bars. A 'Save' button is located at the bottom right.

## Audio

Audio Defocus Motion Network Schedule Tamper

Basic Setting

Sound Intensity Threshold

Enable

50 (1-100)

Handlers

Snapshot

Store to Edge

Store to FTP

Recording

Edge Record

Email

Enable

Subject

Message

OSD

Enable

Text

HTTP Generic Event

Enable

Method 1

Arming Schedule Setting

Edit	0	1	2	3	4	5	6	7	8	9	10	11	12	13	14	15	16	17	18	19	20	21	22	23	24
Monday																									
Tuesday																									
Wednesday																									
Thursday																									
Friday																									
Saturday																									
Sunday																									

Save

### Basic Setting

**Enable:** Check to activate the audio event handling.

**Sound Intensity Threshold:** Drag the slider to set the sensitivity.

#### Handlers:

**Snapshot:** If an event occurs, the camera will store a snapshot image.

**Store to Edge:** Check to store snapshot images to the cameras SD-card.

**Store to FTP:** Check to store snapshot images to the configured FTP Server.

**Recording:** If an event occurs, the camera will record a video sequence.

**Store to Edge:** Check to store the event video to the cameras SD-card.

**Email:** If an event occurs, an email message can be sent to the configured mail server.

**Enable:** Check to sent an email when an event occurs.

**Subject:** Enter the email subject.

**Message:** Enter the email message.

**OSD:** If an event occurs, an OSD message can be displayed on the camera image.

**Enable:** Check to display a message on the image when an event occurs.

**Text:** Enter the message text.

**HTTP Generic Event:** If an event occurs, an HTTP Generic Event can be sent (see [HTTP Generic Event](#), p. 86).

**Enable:** Check to sent an HTTP Generic Event message on the image when an event occurs.

**Method:** Select a configured HTTP Generic Event method.

## Arming Schedule Setting

see [Arming Schedule Setting](#), p. 75.

## Defocus

Audio
Defocus
Motion
Network
Schedule
Tamper

**Basic Setting**

Enable

**Handlers**

Snapshot	Recording
<input type="checkbox"/> Store to Edge	<input type="checkbox"/> Edge Record
<input type="checkbox"/> Store to FTP	

Email	OSD	HTTP Generic Event
<input type="checkbox"/> Enable Subject <input style="width: 100%;" type="text"/> Message <input style="width: 100%; height: 40px;" type="text"/>	<input type="checkbox"/> Enable Text <input style="width: 100%;" type="text"/>	<input type="checkbox"/> Enable Method <span style="border: 1px solid #ccc; padding: 2px;">1</span>

**Arming Schedule Setting**

	Edit	0	1	2	3	4	5	6	7	8	9	10	11	12	13	14	15	16	17	18	19	20	21	22	23	24
Monday																										
Tuesday																										
Wednesday																										
Thursday																										
Friday																										
Saturday																										
Sunday																										

## Basic Setting

**Enable:** Check to activate the Defocus event handling.

### Handlers:

**Snapshot:** If an event occurs, the camera will store a snapshot image.

**Store to Edge:** Check to store snapshot images to the cameras SD-card.

**Store to FTP:** Check to store snapshot images to the configured FTP Server.

**Recording:** If an event occurs, the camera will record a video sequence.

**Store to Edge:** Check to store the event video to the cameras SD-card.

**Email:** If an event occurs, an email message can be sent to the configured mail server.

**Enable:** Check to sent an email when an event occurs.

**Subject:** Enter the email subject.

**Message:** Enter the email message.

**OSD:** If an event occurs, an OSD message can be displayed on the camera image.

**Enable:** Check to display a message on the image when an event occurs.

**Text:** Enter the message text.

**HTTP Generic Event:** If an event occurs, an HTTP Generic Event can be sent (see [HTTP Generic Event, p. 86](#)).

**Enable:** Check to sent an HTTP Generic Event message on the image when an event occurs.

**Method:** Select a configured HTTP Generic Event method.

## Arming Schedule Setting

see [Arming Schedule Setting, p. 75](#).

## Motion

Audio Defocus **Motion** Network Schedule Tamper

Motion Zone Area Setting

Object Size  (1-100) Sensitivity

Zone1

Enable

Handlers

Snapshot	Recording
<input type="checkbox"/> Store to Edge	<input type="checkbox"/> Edge Record
<input type="checkbox"/> Store to FTP	

Email	OSD	HTTP Generic Event
Enable <input type="checkbox"/>	Enable <input checked="" type="checkbox"/>	Enable <input type="checkbox"/>
Subject	Text: Kivi Event	Method: 1
Message		

Zone2

Zone3

Zone4

Arming Schedule Setting

Edit	0	1	2	3	4	5	6	7	8	9	10	11	12	13	14	15	16	17	18	19	20	21	22	23	24
Monday																									
Tuesday																									
Wednesday																									
Thursday																									
Friday																									
Saturday																									
Sunday																									

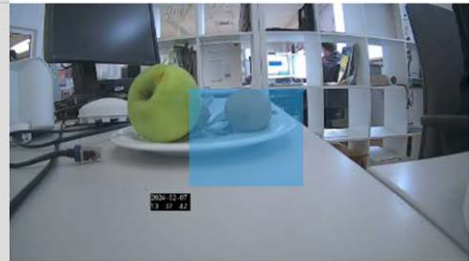

### Motion Zone Area Setting

You can customize up to four different zones for motion detection in the camera image.

**Object Size:** Set the size of the object which should trigger a motion detection event. The lower the value, the smaller the object that is to trigger an event

**Sensitivity:** Specify the sensitivity for motion detection. High means that the camera will trigger even with slight movements or changes in light.

**Enable:** Check to activate the Motion Detection event handling per zone.

#### Handlers:

**Snapshot:** If an event occurs, the camera will store a snapshot image.

**Store to Edge:** Check to store snapshot images to the cameras SD-card.

**Store to FTP:** Check to store snapshot images to the configured FTP Server.

**Recording:** If an event occurs, the camera will record a video sequence.

**Store to Edge:** Check to store the event video to the cameras SD-card.

**Email:** If an event occurs, an email message can be sent to the configured mail server.

**Enable:** Check to sent an email when an event occurs.

**Subject:** Enter the email subject.

**Message:** Enter the email message.

**OSD:** If an event occurs, an OSD message can be displayed on the camera image.

**Enable:** Check to display a message on the image when an event occurs.

**Text:** Enter the message text.

**Email:** If an event occurs, an email message can be sent to the configured mail server.

**Enable:** Check to sent an email when an event occurs.

**Subject:** Enter the email subject.

**Message:** Enter the email message.

**HTTP Generic Event:** If an event occurs, an HTTP Generic Event can be sent (see [HTTP Generic Event, p. 86](#)).

**Enable:** Check to sent an HTTP Generic Event message on the image when an event occurs.

**Method:** Select a configured HTTP Generic Event method.

## Arming Schedule Setting

see [Arming Schedule Setting, p. 75](#).

## Network

The screenshot shows a configuration window with tabs for Audio, Defocus, Motion, Network, Schedule, and Tamper. The 'Network' tab is active. Under 'Basic Setting', there are several sections:

- Wired Network Loss:** A dropdown menu with a gear icon.
- Enable:** A checkbox that is currently unchecked.
- Handlers:** A dropdown menu.
- Recording:** A section containing an 'Edge Record' checkbox, which is unchecked.
- OSD:** A section containing an 'Enable' checkbox (unchecked) and a 'Text' input field.
- Wired Network Conflict:** A dropdown menu with a gear icon.



## Network

The camera can handle events of Wired Network Loss and Wired Network Conflicts.

**Enable:** Check to activate the Network event handling.

### Handlers:

**Recording:** If an event occurs, the camera will record a video sequence.

**Store to Edge:** Check to store the event video to the camera's SD-card.

**OSD:** If an event occurs, an OSD message can be displayed on the camera image.

**Enable:** Check to display a message on the image when an event occurs.

**Text:** Enter the OSD message text.

## Arming Schedule Setting

see [Arming Schedule Setting, p. 75](#).

## Schedule

Audio Defocus Motion Network **Schedule** Tamper

Basic Setting

Enable  Mode **Regular** Trigger Interval  (5~3600)Sec

Handlers

Snapshot

Store to Edge  Store to FTP

Recording

Edge Record

Email

Enable

Subject

Message

Arming Schedule Setting

Edit	0	1	2	3	4	5	6	7	8	9	10	11	12	13	14	15	16	17	18	19	20	21	22	23	24
Monday																									
Tuesday																									
Wednesday																									
Thursday																									
Friday																									
Saturday																									
Sunday																									

## Basic Setting

**Enable:** Check to activate the schedule event handling.

### Mode:

**Regular:** Select if the recording, when activated, is to continue regularly based on the set trigger interval.

**Persist:** In "Regular" mode, the action is triggered at the selected interval.

**Trigger Interval:** It's about interval pertaining to above "Regular" mode. For example, if "60", schedule under Regular mode triggers on 60 seconds per time.

**Handlers:**

**Snapshot:** If an event occurs, the camera will store a snapshot image.

**Store to Edge:** Check to store snapshot images to the cameras SD-card.

**Store to FTP:** Check to store snapshot images to the configured FTP Server.

**Recording:** If an event occurs, the camera will record a video sequence.

**Store to Edge:** Check to store the event video to the cameras SD-card.

**Email:** If an event occurs, an email message can be sent to the configured mail server.

**Enable:** Check to sent an email when an event occurs.

**Subject:** Enter the email subject.

**Message:** Enter the email message.

### Arming Schedule Setting

see [Arming Schedule Setting, p. 75.](#)

## Tamper

This function is used to trigger corresponding actions in the event of manipulation events on the camera.

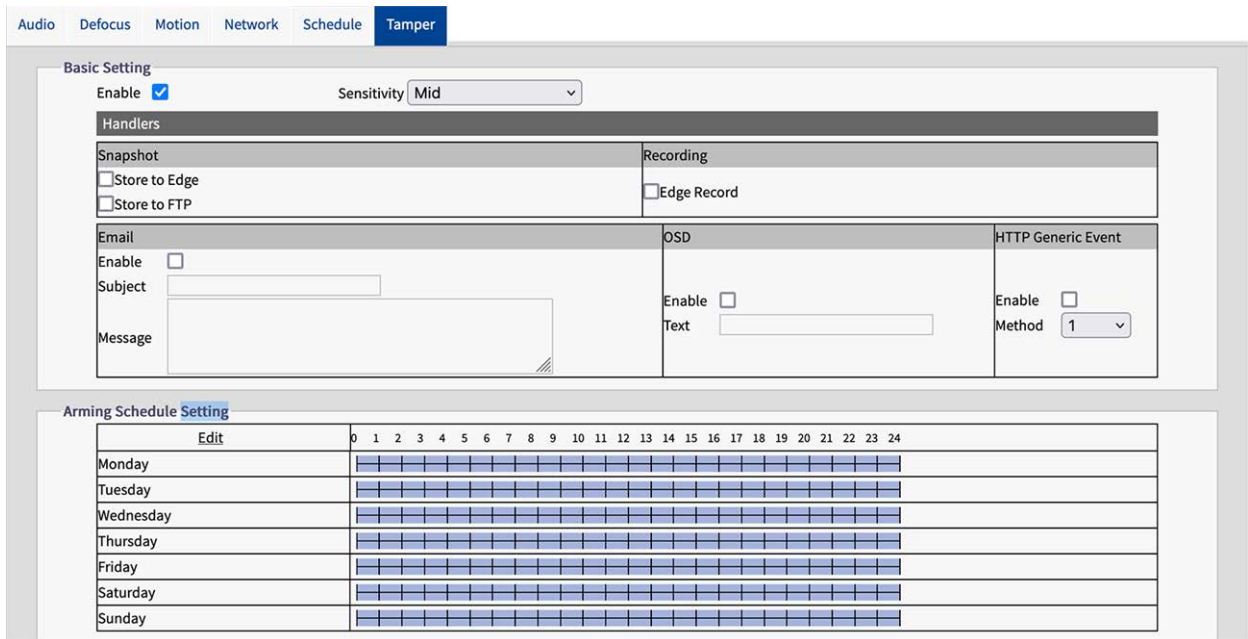

### Basic Setting

**Enable:** Check to activate the tamper event handling.

**Sensitivity:** Set the sensitivity for tampering detection. High means that the camera is triggered even in the event of slight tampering, while Low means that the camera is only triggered in the event of major tampering.

**Handlers:**

**Snapshot:** If an event occurs, the camera will store a snapshot image.

**Store to Edge:** Check to store snapshot images to the cameras SD-card.

**Store to FTP:** Check to store snapshot images to the configured FTP Server.

**Recording:** If an event occurs, the camera will record a video sequence.

**Store to Edge:** Check to store the event video to the cameras SD-card.

**Email:** If an event occurs, an email message can be sent to the configured mail server.

**Enable:** Check to sent an email when an event occurs.

**Subject:** Enter the email subject.

**Message:** Enter the email message.

**OSD:** If an event occurs, an OSD message can be displayed on the camera image.

**Enable:** Check to display a message on the image when an event occurs.

**Text:** Enter the message text.

**HTTP Generic Event:** If an event occurs, an HTTP Generic Event can be sent (see [HTTP Generic Event, p. 86](#)).

**Enable:** Check to sent an HTTP Generic Event message on the image when an event occurs.

**Method:** Select a configured HTTP Generic Event method.

**Arming Schedule Setting**

see [Arming Schedule Setting, p. 75](#).

**Arming Schedule Setting**

Arming Schedule Setting	
Edit	0 1 2 3 4 5 6 7 8 9 10 11 12 13 14 15 16 17 18 19 20 21 22 23 24
Monday	[Arming Schedule Grid]
Tuesday	[Arming Schedule Grid]
Wednesday	[Arming Schedule Grid]
Thursday	[Arming Schedule Grid]
Friday	[Arming Schedule Grid]
Saturday	[Arming Schedule Grid]
Sunday	[Arming Schedule Grid]

## Configuration

### Configuration

---

1. Click Edit.
2. Set up to three time periods for each day.

	Start Time	End Time	Action
<b>Monday</b>			
	<input type="text" value="00:00"/>	<input type="text" value="06:00"/>	<input checked="" type="checkbox"/>
	<input type="text" value="06:00"/>	<input type="text" value="19:59"/>	<input type="checkbox"/>
	<input type="text" value="20:00"/>	<input type="text" value="23:59"/>	<input checked="" type="checkbox"/>
<b>Tuesday</b>			
	<input type="text" value="00:00"/>	<input type="text" value="06:00"/>	<input checked="" type="checkbox"/>
	<input type="text" value="06:00"/>	<input type="text" value="19:59"/>	<input type="checkbox"/>
	<input type="text" value="20:00"/>	<input type="text" value="23:59"/>	<input checked="" type="checkbox"/>
<b>Wednesday</b>			
	<input type="text" value="00:00"/>	<input type="text" value="06:00"/>	<input checked="" type="checkbox"/>
	<input type="text" value="06:00"/>	<input type="text" value="19:59"/>	<input type="checkbox"/>
	<input type="text" value="20:00"/>	<input type="text" value="23:59"/>	<input checked="" type="checkbox"/>
<b>Thursday</b>			
	<input type="text" value="00:00"/>	<input type="text" value="06:00"/>	<input checked="" type="checkbox"/>
	<input type="text" value="06:00"/>	<input type="text" value="19:59"/>	<input type="checkbox"/>
	<input type="text" value="20:00"/>	<input type="text" value="23:59"/>	<input checked="" type="checkbox"/>
<b>Friday</b>			
	<input type="text" value="00:00"/>	<input type="text" value="06:00"/>	<input checked="" type="checkbox"/>
	<input type="text" value="06:00"/>	<input type="text" value="19:59"/>	<input type="checkbox"/>
	<input type="text" value="20:00"/>	<input type="text" value="23:59"/>	<input checked="" type="checkbox"/>
<b>Saturday</b>			
	<input type="text" value="00:00"/>	<input type="text" value="23:59"/>	<input checked="" type="checkbox"/>
	<input type="text" value="00:00"/>	<input type="text" value="23:59"/>	<input checked="" type="checkbox"/>
	<input type="text" value="00:00"/>	<input type="text" value="23:59"/>	<input checked="" type="checkbox"/>
<b>Sunday</b>			
	<input type="text" value="00:00"/>	<input type="text" value="23:59"/>	<input type="checkbox"/>
	<input type="text" value="00:00"/>	<input type="text" value="23:59"/>	<input checked="" type="checkbox"/>
	<input type="text" value="00:00"/>	<input type="text" value="23:59"/>	<input checked="" type="checkbox"/>

3. Check for each time period if events should be handled.
4. Click "Apply" to save your settings.

## Video Analytics

Video Analytics (VA) includes the proprietary algorithm for performing intelligent video analytics, such as detecting intruders or loitering in a specific area based on suspicious objects or counting

people and traffic flows.



## General

This page contains general settings that apply to all Video Analytics functions. Before setting up the individual VA functions, you should define the basic settings here.



### Basic Setting

**Sensitivity:** Select a sensitivity level to set a threshold value for triggering the VA functions. High means that the VA functions are triggered even for small events, while low means that they are only triggered for larger events.

### Size Setting

**Max Object Size:** In the preview image, use the mouse to draw a rectangle that defines the maximum size of the object to be detected and then click on "Save" to activate the settings.

**Min Object Size:** In the preview image, use the mouse to draw a rectangle that defines the minimum size of the object to be detected and then click on "Save" to activate the settings.

**NOTE!** To increase the accuracy of the VA functions, draw the size of the objects to be detected as accurately as possible.

## Line Counting

This function is used to count the number of moving objects that pass a defined line. Possible applications for this function are, for example, entrances and exits of a shopping center. It can also be used to count the flow of traffic.

General **Line Counting** Border Line

Basic Setting

Reference Border Line Reset Counting

Line 1

Enable

Direction A -> B

Handlers

Snapshot	Recording
<input type="checkbox"/> Store to Edge	<input type="checkbox"/> Edge Record
<input type="checkbox"/> Store to FTP	

Email	OSD	HTTP Generic Event
Enable <input type="checkbox"/>	Enable <input type="checkbox"/>	Enable <input type="checkbox"/>
Subject	Text	Method 1
Message		

Line 2

Line 3

Arming Schedule Setting

Edit	0	1	2	3	4	5	6	7	8	9	10	11	12	13	14	15	16	17	18	19	20	21	22	23	24
Monday																									
Tuesday																									
Wednesday																									
Thursday																									
Friday																									
Saturday																									
Sunday																									

Save

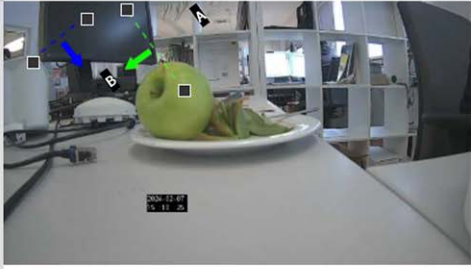

## Basic Setting

Draw a line in the preview image with the mouse.

You can draw up to three lines, each with the following settings:

**Reference Border Line:** Click to set the identical settings from the function for the "Border Line" (see [Border Line](#), p. 79).

**Reset Counting:** Click to set the object count to zero.

You can make the following settings for each line:

**Enable:** Check to activate the Line Counting event handling.

**Direction:** Select the direction in which objects must cross the line to trigger an alarm.

## Handlers:

**Snapshot:** If an event occurs, the camera will store a snapshot image.

**Store to Edge:** Check to store snapshot images to the cameras SD-card.

**Store to FTP:** Check to store snapshot images to the configured FTP Server.

**Recording:** If an event occurs, the camera will record a video sequence.

**Store to Edge:** Check to store the event video to the cameras SD-card.

**Email:** If an event occurs, an email message can be sent to the configured mail server.

**Enable:** Check to sent an email when an event occurs.

**Subject:** Enter the email subject.

**Message:** Enter the email message.

**OSD:** If an event occurs, an OSD message can be displayed on the camera image.

**Enable:** Check to display a message on the image when an event occurs.

**Text:** Enter the message text.

**HTTP Generic Event:** If an event occurs, an HTTP Generic Event can be sent (see [HTTP Generic Event, p. 86](#)).

**Enable:** Check to sent an HTTP Generic Event message on the image when an event occurs.

**Method:** Select a configured HTTP Generic Event method.

## Arming Schedule Setting

see [Arming Schedule Setting, p. 75](#).

## Border Line

With this function, you can set border lines to survey specific areas within the camera's field of view. You can draw multiple lines around a specific area to monitor it, and as soon as the defined area is entered, an action can be triggered.

General
Line Counting
Border Line

**Basic Setting**

Reference Line Counting

Line1 ⌵

Enable  Direction A -> B ⌵

**Handlers**

Snapshot	Recording
<input type="checkbox"/> Store to Edge	<input type="checkbox"/> Edge Record
<input type="checkbox"/> Store to FTP	

Email	OSD	HTTP Generic Event
Enable <input type="checkbox"/>	Enable <input type="checkbox"/>	Enable <input type="checkbox"/>
Subject <input style="width: 90%;" type="text"/>	Text <input style="width: 90%;" type="text"/>	Method <span style="border: 1px solid #ccc; padding: 2px 5px;">1</span> <span style="float: right;">⌵</span>
Message <div style="border: 1px solid #ccc; height: 20px; width: 100%;"></div>		

Line2 ⌵

Line3 ⌵

**Arming Schedule Setting**

Edit	0	1	2	3	4	5	6	7	8	9	10	11	12	13	14	15	16	17	18	19	20	21	22	23	24
Monday																									
Tuesday																									
Wednesday																									
Thursday																									
Friday																									
Saturday																									
Sunday																									

Save



## Basic Setting

Draw a line in the preview image with the mouse.

You can draw up to three lines, each with the following settings:

**Reference Border Line:** Click to set the identical settings from the "Line Counting" function(see [Line Counting, p. 77](#)).

You can make the following settings for each line:

**Enable:** Check to activate the Border Line event handling.

**Direction:** Select the direction in which objects must cross the line to trigger an alarm.



## Handlers:

**Snapshot:** If an event occurs, the camera will store a snapshot image.

**Store to Edge:** Check to store snapshot images to the cameras SD-card.

**Store to FTP:** Check to store snapshot images to the configured FTP Server.

**Recording:** If an event occurs, the camera will record a video sequence.

**Store to Edge:** Check to store the event video to the cameras SD-card.

**Email:** If an event occurs, an email message can be sent to the configured mail server.

**Enable:** Check to sent an email when an event occurs.

**Subject:** Enter the email subject.

**Message:** Enter the email message.

**OSD:** If an event occurs, an OSD message can be displayed on the camera image.

**Enable:** Check to display a message on the image when an event occurs.

**Text:** Enter the message text.

**HTTP Generic Event:** If an event occurs, an HTTP Generic Event can be sent (see [HTTP Generic Event, p. 86](#)).

**Enable:** Check to sent an HTTP Generic Event message on the image when an event occurs.

**Method:** Select a configured HTTP Generic Event method.

## Arming Schedule Setting

see [Arming Schedule Setting, p. 75](#).

## Event Setting

In this section, you can make detailed settings that define how the camera should process events that occur.

Live View Configuration English User:admin | Logout

Email FTP Record Setting SD Card Snapshot HTTP Generic Event

Advanced Configuration

- Encode
- Image
- Lens Control
- Video
- Network
- System
- Account
- Event Source
- Video Analytics
- Event Setting

Basic Setting

Authentication: No\_Auth

Server Address: \_\_\_\_\_

Port: \_\_\_\_\_

User Name: \_\_\_\_\_

Password: \_\_\_\_\_

Sender Settings

Sender Email Address: \_\_\_\_\_

Attach Image: Off

Email Address List

No.	Enable	Email Address
1	<input type="checkbox"/>	_____
2	<input type="checkbox"/>	_____
3	<input type="checkbox"/>	_____
4	<input type="checkbox"/>	_____
5	<input type="checkbox"/>	_____
6	<input type="checkbox"/>	_____
7	<input type="checkbox"/>	_____
8	<input type="checkbox"/>	_____
9	<input type="checkbox"/>	_____
10	<input type="checkbox"/>	_____

Save

## Email

In this section, you can make detailed settings for e-mail notification of events.

**NOTE!** To use this function, make sure that you have activated the sending of e-mails in the event source settings (see [Event Source, p. 67](#)).

Email FTP Record Setting SD Card Snapshot HTTP Generic Event

Basic Setting

Authentication: No\_Auth

Server Address: \_\_\_\_\_

Port: \_\_\_\_\_

User Name: \_\_\_\_\_

Password: \_\_\_\_\_

Sender Settings

Sender Email Address: \_\_\_\_\_

Attach Image: Off

Email Address List

No.	Enable	Email Address
1	<input type="checkbox"/>	_____
2	<input type="checkbox"/>	_____
3	<input type="checkbox"/>	_____
4	<input type="checkbox"/>	_____
5	<input type="checkbox"/>	_____
6	<input type="checkbox"/>	_____
7	<input type="checkbox"/>	_____
8	<input type="checkbox"/>	_____
9	<input type="checkbox"/>	_____
10	<input type="checkbox"/>	_____

Save

## Basic Setting

**Authentication:** Select an authentication type:

**No\_Auth:** No restriction (default)

**SMTP\_Plain:** PLAIN is the name of a registered SASL authentication mechanism that serves as a parameter for the AUTH command. The PLAIN authentication mechanism is described in RFC 2595. Plain is the least secure of all SASL authentication mechanisms, as the password is sent unencrypted over the network.

**Login:** The login mechanism is supported by various e-mail clients.

**TLS\_TTLS:** TLS (Transport Layer Security) is usually implemented in addition to one of the transport layer protocols that encapsulate application-specific protocols such as HTTP, FTP, SMTP, NNTP and XMPP. The TLS protocol enables client-server applications to communicate over a network in a way that prevents eavesdropping and tampering.

**Server Address:** Enter the server address of the mail server

**Port:** Enter the port for communication with the mail server. Usually the port number is 25.

**User Name:** Enter the user name with which you log on to the mail server.

**Password:** Enter the password of the user with which you log on to the mail server.

## Sender Setting

**Sender Email Address:** Enter the Sender Email Address

**Attach Image:** Set to "ON" to add an image of the time of the event as an attachment.

## Email Address List

This function can be used to notify up to 10 recipients by e-mail when events occur.

**Enable:** Check to activate the corresponding email address.

**Email Address:** Enter the email address of the recipient to be notified.

## FTP

In this section, you can connect a FTP Server to which images can be uploaded, when an event occurs.

**NOTE!** To use this function, make sure that you have activated store to FTP option in event source settings (see [Event Source](#), p. 67).

## Configuration

### Configuration

Email **FTP** Record Setting SD Card Snapshot HTTP Generic Event

Basic Setting

Server Address

Port  (21, 1025-65535)

User Name

Password

Mode

Save

### Basic Setting

**Server Address:** Enter the server address of the FTP server.

**Port:** Enter the port for communication with the FTP server. Usually the port number is 21.

**User Name:** Enter the user name with which you log on to the FTP server.

**Password:** Enter the password of the user with which you log on to the FTP server.

**Mode:** Select a, which connection mode should be used:

**Active:** If you select "Active", the camera connects continuously to the FTP server, which requires more network bandwidth but enables an immediate response.

**Passive:** If you select the "Passive" option, the camera only establishes a connection to the FTP server when required.

### Record Setting

You can make detailed settings for video recording in this section.

**NOTE!** To use this function, make sure that you have activated recording option in the event source settings (see [Event Source](#), p. 67).

Email FTP **Record Setting** SD Card Snapshot HTTP Generic Event

Basic Setting

Record Type

Record Status

Clip Duration  (5-10 Sec)

Clip Size  (50-100 MB)

Record Codec

Save

### Basic Setting

**Record Type:** Select a, which connection mode should be used:

**Video:** Only video will be recorded on event trigger (default).

**Audio And Video:** Both video and audio will be recorded on event.

**Record Status:** Select a, which connection mode should be used:

**One Shot:** On event the camera records video with designated duration and file size (default).

**Continuous:** The camera keeps recording video continuously.

**Clip Duration:** If record mode "One Shot" is selected you can set a clip duration between 5 and 10 seconds.

**Clip Size:** If record mode "One Shot" is selected you can set a clip size between 50 and 100 MB.

**Record Codec:** Select the preferred codec for MPEG recording. Available codecs are H.264 and H.265 (default)

## SD Card

In this section, you can make detailed settings for event recording on the SD card for events. You can also search for recordings on the SD card and download them.

**NOTE!** To use this function, make sure that you have activated recording option in the event source settings (see [Event Source](#), p. 67).

The screenshot shows the 'SD Card' configuration page. It includes a 'Basic Setting' section with 'Overwrite' set to 'Off', 'Status' as 'SD card not inserted', and 'Encrypted Mode' set to 'Off'. A 'Format' button is also present. Below this is a 'Download SD File' section featuring a calendar for February 2024, a search bar, and an empty table with columns for 'Folder name', 'File name', and 'File size'. The table has a 'Select All' checkbox and a 'Download' button at the bottom right. A 'Save' button is located at the bottom right of the entire configuration area.

## Basic Setting

### Overwrite:

**Off:** Recordings on the SD card are not overwritten (default).

**On:** The recordings are overwritten as soon as the SD card is full. The oldest files are overwritten first. The process is started as soon as the remaining capacity of the built-in SD card is less than 20 MB.

## Configuration

### Configuration

---

**Encryption Mode:** Data on the SD card is encrypted:

**Off:** Select this option if the data stored on the SD card is not to be encrypted. (default).

**On:** Select this option if the data stored on the SD card is to be encrypted.

**SD Format:** Click to format the SD Card.

**NOTE!** Formatting the SD card, will always delete any data in the SD card no matter Encryption Mode is “On” or “Off”.

**NOTE!** To access data stored on the SD card from Windows OS or Mac OS, a third party ext4 driver or application is required.

## Snapshot

In this section, you can make detailed settings for capturing snapshots of events.

**NOTE!** To use this function, make sure that you have activated snapshot options in the event source settings (see [Event Source, p. 67](#)).

The screenshot shows a configuration interface with several tabs: Email, FTP, Record Setting, SD Card, Snapshot (selected), and HTTP Generic Event. Under the Snapshot tab, there is a section titled "Basic Setting" with three rows of settings:

Setting	Value	Range
Pre Event Capture Count	3	(1~10 Frame)
Event Capture Interval	1	(1~10 Sec)
Post Event Capture Count	3	(1~infinite Frame)

A "Save" button is located at the bottom right of the configuration area.

### Basic Setting

**Pre Event Capture Count:** Set a number of frames to be captured prior to an event. Maximum 10 frames are possible.

**Event Capture Interval:** Set a time interval ranging from 1 to 10 seconds between each snapshot capture.

**Post Event Capture Count:** Set a number of frames to be captured after an event occurred.

### HTTP Generic Event

HTTP Generic Event, you can send messages and commands, for example, directly to a network video recorder (NVR) that supports the CGI command function. You can customize the messages and commands as required in the event source settings.

**NOTE!** To use this function, make sure that you have activated HTTP Generic Event options in the event source settings (see [Event Source, p. 67](#)).

## Basic Setting

**Method:** Select the Event Method you want to specify. If necessary, ask your administrator about the required method.

**Title:** Set the title of the event messages.

**URL:** Enter the web address of the event recipient.

**Option:** Select the method of the event transmission.

**GET:** The Get method is a simple and fast method to transmit messages but it is less secure than Post.

**POST:** The Post method is a more complicated way of transmitting messages, but also somewhat more secure than the Get method.

**User Name:** Enter the user name with which you log on to the server.

**Password:** Enter the password of the user with which you log on to the server.

**Active Message:** The camera will send an active message to Server when an trigger event occurs.

**Inactive Message:** The camera will send an inactive message to Server when an trigger event occurs.





## Technical Support Information

This section contains the following information:

<b>Technical Specifications</b> .....	<b>90</b>
---------------------------------------	-----------

# Technical Specifications

## Product Information

Product Name	5MP Varifocal IR Vandal Turret
Order Code	Mx-VT1A-503-IR

## Hardware Design

Processor	Novatec NT98560 (Single-core ARM® Cortex®-A9, 960 MHz)
Memory	RAM: 512 MBytes FLASH: 256 MBytes
Image Sensor	5MP, 1/2.8" Progressive CMOS
Effective (Used) Pixels	2608x1964 (5MP)

## Lens

Minimum Illumination	Color: 0.18 lux B/W: 0.09 lux, (0 lux, IR on) F1.6, AGC=on, 30 IRE, 1/1 s
Lens Characteristics	Vari-Focal Lens Focal Length: 2.7mm to 13.5mm Aperture: F1.4-2.8 H x V FOV: 103°-31°(H) 76°-23°(V)

## Camera

Day/Night	Automatically switchable IR-cut filter
Shutter Speed	Auto / Manual / WDR: 1 to 1/10000 s
Shutter Priority Mode	Up to 1/7.5 s
Frame Rate (maximum)	<b>WDR on/off:</b> H.265/H.264: 5MP@30 fps MJPEG: 1080p@30 fps
Auto Gain	Min. gain: 0 dB, max. gain: 36 dB, step size: 3

WDR	Up to 120 dB
Zoom	Motorized optical: 2.67x
Image Settings	Color, Brightness, Sharpness, Contrast, White Balance, Gain Control, 2DNR, 3DNR, BLC, EV, Gamma corection, Saturation, Hue
Image Rotation	90°, 180°, 270°
Camera Body Adjust	Pan/Tilt/Rotation

## Video Codec

Compression/Encoding	H.265/H.264/MJPEG
Streaming	Up to 3 individually configurable streams in H.264/H.265/MJPEG. Configurable resolution, frame rate, bandwidth CVBR/CBR/istream in H.265/H.264

## Audio Codec

Compression/Encoding	G.711a/u
Streaming	One-way
Audio Input	Integrated Microphone

## Network

Interface	10/100 Mbps Ethernet
Supported Protocols	ARP, DHCP, DNS, FTP, HTTP, HTTPS, ICMP, IGMP, IPv4/6, NTP, RTSP/RTCP/RTP, RTMP, QoS, SMTP, SNMP v1/2c/3, TCP, TLS/TTLS, UDP, UPnP, 802.1X, Bonjour, DDNS, PPPoE
ONVIF conformance	Supports profiles S/G/T/M
Supported Browsers	Microsoft Edge, Firefox, Google Chrome

## System Integration

Event Actions	<ul style="list-style-type: none"> <li>▪ Schedule Recording (JPG/MP4)</li> <li>▪ DNN-based video analytics (line counting, border line, object classification/filtering for people, vehicles, etc.)</li> <li>▪ Video and audio recording to edge storage</li> <li>▪ File upload: FTP and email</li> <li>▪ Notification: Email (JPG)</li> <li>▪ OSD indication</li> <li>▪ SD Card recording (*JPG/MP4)</li> </ul>
---------------	--

## General

Housing Material	Metal
Housing Color	RAL 9003
Adaptive IR Illumination	850 nm; up to 30 m/98 ft distance depending on reflection of scenery
Video Storage	Micro SD card support up to 512 GB. Support for recording to MOVE NVR, MOBOTIX Cloud (via MOBOTIX Bridge), MOBOTIX HUB, MxMC (via MOBOTIX NAS)
Remotely Upgradable	Yes
Power Requirements	IEEE802.3af, class 3, max 10 watt DC12V, max 10 watt
Connectors	<ul style="list-style-type: none"> <li>▪ RJ45</li> <li>▪ 1 x DC 12V Jack Socket</li> <li>▪ 1 x Reset / Default Button</li> </ul>
Environmental Protection Class	IP66/IK10
Operating Temperature	-30°C to 60°C/-22°F to 140 °F with heater
Relative Humidity	95 % non-condensing
Storage Conditions	-40 to 60 °C/-4 to 158 °F
Approvals	EMC: CE/FCC/BIS Safety: LVD

Warranty	5 years; mechanically wearable parts (motor, gears, belts, etc.) excluded
Dimensions	ø 120 x 104 mm (overall)
Weight	715 g

---

**NOTE!** Observe the [MOBOTIX MOVE Installation Hints](#) document to ensure optimum performance of the camera features.

# MOBOTIX

BeyondHumanVision

EN\_08/24

MOBOTIX AG • Kaiserstrasse • D-67722 Langmeil • Tel.: +49 6302 9816-103 • sales@mobotix.com • www.mobotix.com

MOBOTIX is a trademark of MOBOTIX AG registered in the European Union, the U.S.A., and in other countries. Subject to change without notice. MOBOTIX do not assume any liability for technical or editorial errors or omissions contained herein. All rights reserved. © MOBOTIX AG 2021