

User Guide

MOBOTIX MOVE 2MP Vandal Bullet ALPR Camera

© 2024 MOBOTIX AG



BeyondHumanVision

MOBOTIX MOVE

Table of Contents

Table of Contents	2
Before You Start	7
Support	8
MOBOTIX Support	8
MOBOTIX eCampus	8
MOBOTIX Community	8
Safety Notes	9
Legal Notes	9
Overview	11
About the Camera	12
Features	12
Package Contents	13
Dimensions	14
Accessories for Bullet Cameras	16
Dimensions	17
Accessories for All Cameras	18
microSD Card Slot/Reset Button	22
Further Reading	23
Connection	25
Camera Cabling	26
All-in-One Cable	26
Connecting Power	27
Connecting Ethernet Cable	27
Connect Alarm I/O	28
Waterproof Cable Connectors	28
Installation	29
General Remarks	30
Ceiling/Wall Mounting	30
Configuration	33
System Requirements for Operating the Camera	34
Accessing the Camera	34
Setting the Video Resolution	36
Default Resolution	36

Exporting/Importing Configuration Files	37
Menu Reference	39
The Camera Menu	40
The “Home” Tab	41
Function Items on Home Page	42
The “System” Tab	45
System	45
Security	47
Network	54
DDNS	61
Mail	62
FTP	62
HTTP	62
Events (Alarm Settings)	63
Storage Management	75
Recording	79
Schedule	80
File Location (Snapshots and Web Recording)	81
View Information	81
Factory Default	82
Software Version	83
Software Upgrade	83
Maintenance	84
The “Streaming” Tab	85
Video Configuration	85
Video Rotation	88
Video Text Overlay	88
Video ROI	90
Video ROI Encoding	90
Video OCX Protocol	91
Video Mask	91
Audio (Audio Mode and Bit Rate Settings)	92
The “Camera” Tab	94
Exposure	94
White Balance	97
Picture Adjustment	100
Color Style	101
IR Function	101

Table of Contents

Noise Reduction	103
WDR Function	104
Digital Zoom	104
Backlight	104
Defog	104
Profile	104
TV System	105
The “Logout” Tab	107
Appendix A: Installing UPnP Components	108
Appendix B: Converting IP Addresses from Decimal to Binary	108
Appendix C: List of Open/Closed IP Ports	110
TCP Protocol	110
UDP Protocol	110
ALPR Best Practices	113
Introduction	114
Best Practices in positioning and setting up the MOBOTIX MOVE camera	114
Camera Setup and Configuration for License Plate Recognition	115
Setting up the MOBOTIX MOVE Camera	115
Licensing ALPR	127
Online Licensing	127
Offline Licensing	130
Starting the ALPR software	135
Configuring ALPR	138
ALPR Settings	138
ALPR Plates	157
ALPR Database	158
ALPR Blacklists and Whitelists	162
ALPR Region of Interest	167
ALPR Reporting	170
ALPR Show Logfile	196
Updating the ALPR System Software	198
Troubleshooting	199
ALPR software starts, but suddenly stops	199
ALPR license is valid, but a ‘Check license’ message appears	199
ALPR is running, but not reading plates	199
ALPR is running, but does not read some of the plates	200
Plate patches are inverted on the plates list	200
JSON or XML have been set up, but plates are not received	201

Variables for Dynamic Text Replacement	202
Plate Information	202
Analytics Information	203
Date and Time Information	203
Image Information	204
Lists and Conditionals Information	205
Camera Details and Other Information	206
Note on Timestamp Formats	206
Technical Support Information	207
Technical Specifications	208

Before You Start

This section contains the following information:

Support	8
Safety Notes	9
Legal Notes	9

Support

MOBOTIX Support

If you need technical support, please contact your MOBOTIX dealer. If your dealer cannot help you, he will contact the support channel to get an answer for you as quickly as possible.

If you have internet access, you can open the MOBOTIX help desk to find additional information and software updates.

Please visit www.mobotix.com > Support > Help Desk.



MOBOTIX eCampus

The MOBOTIX eCampus is a complete e-learning platform. It lets you decide when and where you want to view and process your training seminar content. Simply open the site in your browser and select the desired training seminar.

Please visit www.mobotix.com/ecampus-mobotix.



MOBOTIX Community

The MOBOTIX community is another valuable source of information. MOBOTIX staff and other users are sharing their information, and so can you.

Please visit community.mobotix.com.



Safety Notes

- This camera must be installed by qualified personnel and the installation should conform to all local codes.
- This product must not be used in locations exposed to the dangers of explosion.
- Do not look directly into the infra-red LEDs that may be active on the product.
- Do not use this product in a dusty environment.
- Protect this product from moisture or water entering the housing.
- Install this product as outlined in this document. A faulty installation can damage the product!
- Do not replace batteries of the camera. If a battery is replaced by an incorrect type, the battery can explode.
- This equipment is not suitable for use in locations where children are likely to be present.
- External power supplies must comply with the Limited Power Source (LPS) requirements and share the same power specifications with the camera.
- When using a power adapter, the power cord shall be connected to a socket-outlet with proper ground connection.
- To comply with the requirements of EN 50130-4 regarding the power supply of alarm systems for 24/7 operation, it is highly recommended to use an uninterruptible power supply (UPS) for backing up the power supply of this product.

NOTE! Observe the [MOBOTIX MOVE Installation Hints](#) document to ensure optimum performance of the camera features.

Legal Notes

Legal Aspects of Video and Sound Recording

You must comply with all data protection regulations for video and sound monitoring when using MOBOTIX AG products. Depending on national laws and the installation location of the cameras, the recording of video and sound data may be subject to special documentation or it may be prohibited. All users of MOBOTIX products are therefore required to familiarize themselves with all applicable regulations and to comply with these laws. MOBOTIX AG is not liable for any illegal use of its products.

Declaration of Conformity

The products of MOBOTIX AG are certified according to the applicable regulations of the EC and other countries. You can find the declarations of conformity for the products of MOBOTIX AG on www.mobotix.com under **Support > Download Center > Marketing & Documentation > Certificates & Declarations of Conformity**.

RoHS Declaration

The products of MOBOTIX AG are in full compliance with European Unions Restrictions of the Use of Certain Hazardous Substances in Electrical and Electronic Equipment (RoHS Directive 2011/65/EC) as far as they are subject to these regulations (for the RoHS Declaration of MOBOTIX, please see www.mobotix.com, **Support > Download Center > Marketing & Documentation > Brochures & Guides > Certificates**).

Disposal

Electrical and electronic products contain many valuable materials. For this reason, we recommend that you dispose of MOBOTIX products at the end of their service life in accordance with all legal requirements and regulations (or deposit these products at a municipal collection center). MOBOTIX products must not be disposed of in household waste! If the product contains a battery, please dispose of the battery separately (the corresponding product manuals contain specific directions if the product contains a battery).

Disclaimer

MOBOTIX AG does not assume any responsibility for damages, which are the result of improper use or failure to comply to the manuals or the applicable rules and regulations. Our General Terms and Conditions apply. You can download the current version of the **General Terms and Conditions** from our website at www.mobotix.com by clicking on the corresponding link at the bottom of every page. It is the User's responsibility to comply with all applicable local, state, national and foreign laws, rules, treaties and regulations in connection with the use of the Software and Product, including those related to data privacy, the Health Insurance Portability and Accountability Act of 1996 (HIPPA), international communications and the transmission of technical or personal data.

Overview

This section contains the following information:

About the Camera	12
Features	12
Package Contents	13
Dimensions	14
Accessories for Bullet Cameras	16
Accessories for All Cameras	18
microSD Card Slot/Reset Button	22
Further Reading	23

About the Camera

To make use of the camera's advanced video analytics capabilities, please consult the *Introduction to Video Analytics with MOBOTIX MOVE Cameras* manual available on www.mobotix.com > [Support](#) > [Download Center](#) > [Marketing & Documentation](#) > [Manuals](#).

Features

Performant 2MP resolution ALPR (Automatic License Plate Recognition) cameras with integrated high-performance ALPR/OCR engine. The MOBOTIX MOVE Mx-VB1A-2-IR(-D)-ALPR camera extends the existing range of MOVE IP cameras with advanced ALPR features and MMC (make, model, color) vehicle classification “on board”. The MOBOTIX EverClear superhydrophilic and self-cleaning nano coating of the front glass ensures best image quality even in rain and reduces cleaning efforts and operational costs.

- Automatic license plate recognition for all vehicle speeds and stop-and-go applications
- 64 GB SD card pre-installed
- EverClear coating of front glass
- **Mx-VB1A-2-IR-ALPR:** Motorized Vari-Focal Lens 2.7 to 12 mm, F1.6 to F2.9, Zoom, Focus, One-Push AF
- **Mx-VB1A-2-IR-D-ALPR:** Motorized Zoom Lens 9 to 22 mm, F1.6 to F2.4, Zoom, Focus, One-Push AF
- Wide Dynamic Range (WDR) max. 130 dB
- Integrated IR LEDs up to 60 m/197 ft distance visual, 20 m/35 m (66 ft/115 ft) effective for ALPR
- ONVIF Profile S/G/T/M support
- Triple power support (IEEE802.3bt/AC24V/DC24V)
- Temperature Range -55 to 60 °C/-67 to 140 °F with heater
- IP66/IP67 and IK10
- Easily integrated into many common VMS solutions

NOTE! Observe the [MOBOTIX MOVE Installation Hints](#) document to ensure optimum performance of the camera features.

Package Contents

Check the package for the items listed below.

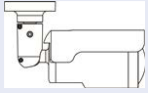

2MP Vandal Bullet ALPR Camera (cable included)

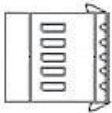

5-Pin Alarm Terminal Block



2-Pin Power Terminal Block



Plastic Dowel (x5)



M5 Standard Screw (x1)



M4 Self-Tapping Screw (x5)



Security Torx Wrench

NOTE! To use an external power supply, contact the camera manufacturer to confirm that the power supply complies with the LPS requirements and shares the same power specifications with the camera.

NOTE! The supplied self-tapping screws are for soft substances/materials such as wood. For other installation environments, such as solid or sheet rock walls, users **MUST** pre-drill and use plastic anchors before fastening the camera onto the wall.

CAUTION! Do not replace batteries of the camera. Risk of explosion may occur if the battery is replaced by an incorrect type.

Dimensions

NOTE! Download the drilling template from the MOBOTIX website: www.mobotix.com > [Support](#) > [Download Center](#) > [Marketing & Documentation](#) > [Drilling Templates](#).

CAUTION! Always print or copy the drilling template at 100% of the original size!

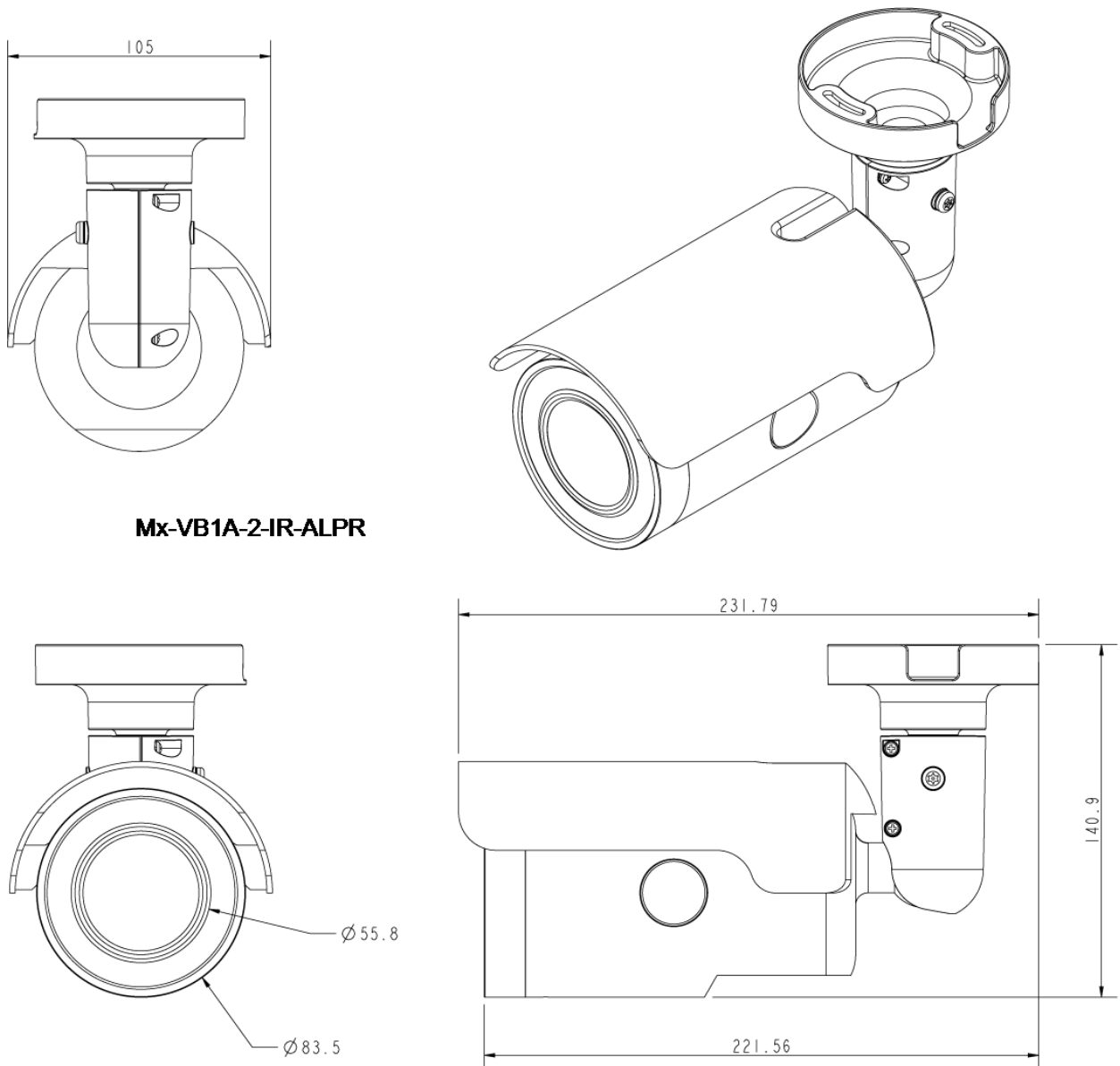

Mx-VB1A-2-IR-ALPR

Fig. 1: Mx-VB1A-2-IR-ALPR: All measurements in mm

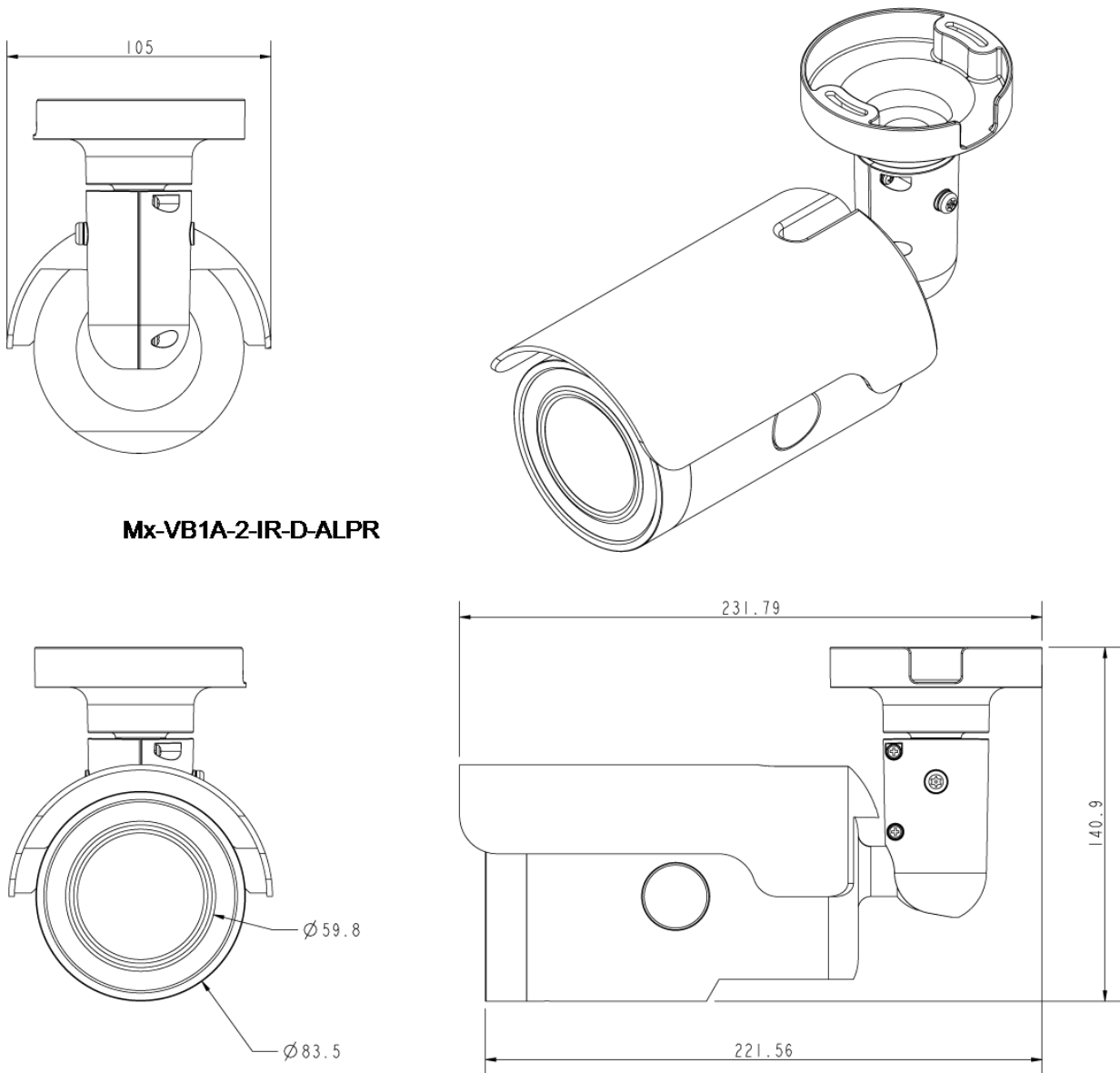

Mx-VB1A-2-IR-D-ALPR

Fig. 2: Mx-VB1A-2-IR-D-ALPR: All measurements in mm

Accessories for Bullet Cameras

Order Code/ Picture	Description	Compatible Products	Material/ Color	Weight (kg)
Mx-M-BC-P 	Weatherproof pole mount for MOVE bullet cameras.	All MOVE Bullet (BC) cameras except Mx-BC1A-2-IR.	Aluminum, RAL9003	1.0
Mx-M-BC-W 	Weatherproof wall mount for MOVE bullet cameras.	All MOVE Bullet (BC) cameras except Mx-BC1A-2-IR.	Aluminum, RAL9003	0.84
Mx-A-VB-FGK-EC 	EverClear-coated front glass for MOVE Vandal Bullet cameras.	All MOVE Vandal Bullet (VB) cameras from Nov. 2021.	Aluminum, glass, rubber	0.033

Dimensions

Order Code

Dimensions

Mx-M-BC-P

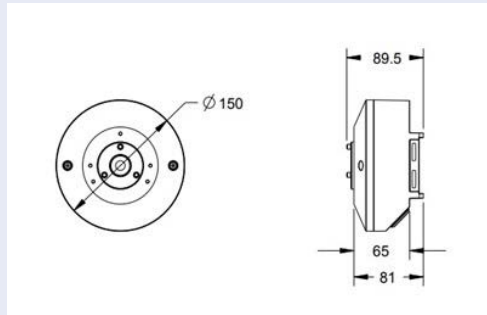

Mx-M-BC-W

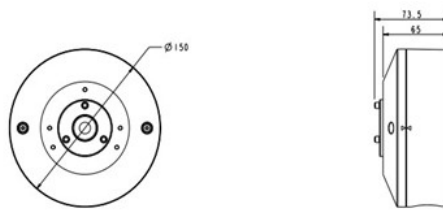



Accessories for All Cameras

Order Code/ Picture	Description	Compatible Products	Material/ Color	Weight (kg)
MX-NPA-UPOE1A- 60W 	<p>UPoE Power Injector 60W.</p> <ul style="list-style-type: none"> PoE++ 60W Network Power injector • AC Input Voltage: 100 to 240 VAC (50 to 60Hz) • AC Input Current: 1.5A @100-240 VAC • Operating Ambient Temperature: • -10° to 40°C @60W • -10° to 50°C, humidity 10 to 90% @30W • IEEE 802.3bt complaint • Output power of 60W over 4-pairs • Supports 10/100/1000Base-T applications • Plug-and-play installation • Full Protection OVP, OCP • Supports 10/100/1000Base-T applications. 	All cameras.	Plastic hous- ing, black	0.45

Overview

Accessories for All Cameras

Order Code/ Picture	Description	Compatible Products	Material/ Color	Weight (kg)
Mx-A-ETP1A- 2601-SET 	<p>Media converter set Ethernet(PoE+) – Twisted-Pair.</p> <p>Complete set consisting of two two-wire transmit/receive units for establishing an Ethernet transmission path via twisted-pair cables.</p> <ul style="list-style-type: none">• Transmission of Ethernet and PoE+ power supply via two-wire line according to IEEE1901.• Simple connection of 10/100 Mbps Ethernet end devices• Max. 95 Mbps transmission bandwidth, range up to 600 m/656 yd for data only, 300 m/328 yd for PoE depending on the quality of the twisted-pair link• 128 bit AES network data encryption• Power supply 2-wire transmitter (Tx) and receiver (Rx) as well as end device via PoE+ network switch or external power supply 56VDC / 1.2A (not included!)• Connected end devices are supplied via PoE switch IEEE802.3af(PoE), IEEE802.3at (PoE+), UPoE up to 60W (requires ext. power supply unit).• Status LEDs (data, power supply, data link, PoE)• Integrated Over-voltage protection (IEC 61000-4-5 4kV(1.2 / 50us), 2kA(8 / 20us))• Power Supply: TX: T-Linx or DC12V~57V, RX: PoE Switch or DC48V~57V• Operational temperature: -20 to 60 °C• Dimensions: 80.4(L) x 61.6(W) x 24(H)mm• Weight: RX/TX: 102g• Warranty: 2 years	All cameras. Requires Mx-A-ETP1A-2601-POW.	Plastic housing, black	0.368

Order Code/ Picture	Description	Compatible Products	Material/ Color	Weight (kg)
Mx-A-ETP1A-2601-POW 	<p>Plug-type power supply for Mx-A-ETP1A-2601-SET.</p> <p>Output: 57V DC +/-3% / 1.2 A • Input: 90-260V AC (47-63Hz) • 68,4 Watt • Operating Temperature: 0–40°C/32–122°F</p>	Mx-A-ETP1A-2601-SET	Plastic housing, black	0.49
Mx-A-KBD1A-PTZ-JOG 	<p>MOBOTIX USB Keyboard with PTZ Joystick & Jog-Shuttle.</p> <p>USB control panel for operating MOBOTIX MxMC 2.6 and higher and MOBOTIX HUB incl. Control of software PTZ and motorized PTZ cameras and pan/tilt devices • Integrated 3-axis joystick • Integrated jog shuttle • 38 control keys with backlight predefined for MxMC functions or freely definable for MOBOTIX HUB • Integrated alarm buzzer • Suitable for operation as HID device on MOBOTIX VMS with Windows and MAC based operating systems via USB 2.0 • Suitable for right- and left-handed users • Power supply: USB, max. 350 mA • Operating temperature: 0°–45°C/32–113 °F.</p>	All cameras. Requires Windows or macOS computer with USB 2.0 or better.	Plastic housing, black	1.9

Overview

microSD Card Slot/Reset Button

Order Code/ Picture	Description	Compatible Products	Material/ Color	Weight (kg)
MX-SWITCH1 	MOBOTIX network switch for DIN (top-hat) rail mounting. 5x RJ45 port with 100 MBit/s (1x uplink, 4x PoE+ with max. 75 W). Supply: 48 V DC, max. 75 W. Simplified cabling for door stations due to available connectivity for anti-theft protection, door opener and MxBus. MxBus, anti-theft protection, door and lock contact can be connected via separate wires of Ethernet cable.	All cameras.	Platic hous- ing, gray	0.31

microSD Card Slot/Reset Button

The camera's microSD card slot and reset button are inside the front housing. If users need to use them, the front housing must be opened. Follow the steps below to reach microSD card slot and reset button.

1. Open up the external cover using a flathead screwdriver.

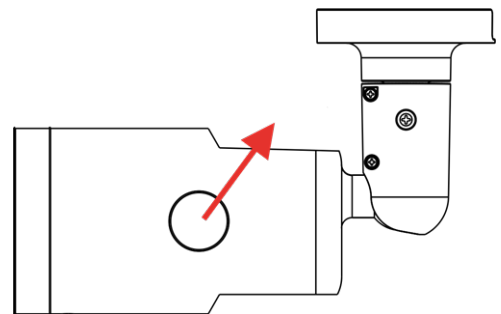

2. Open up the internal cover using a security Torx.

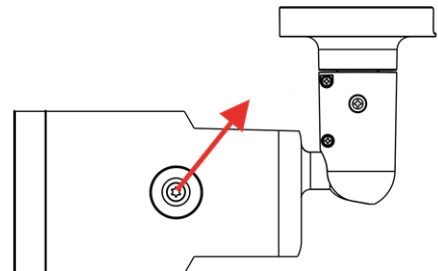

3. The positions of microSD card slot and default button are as shown.

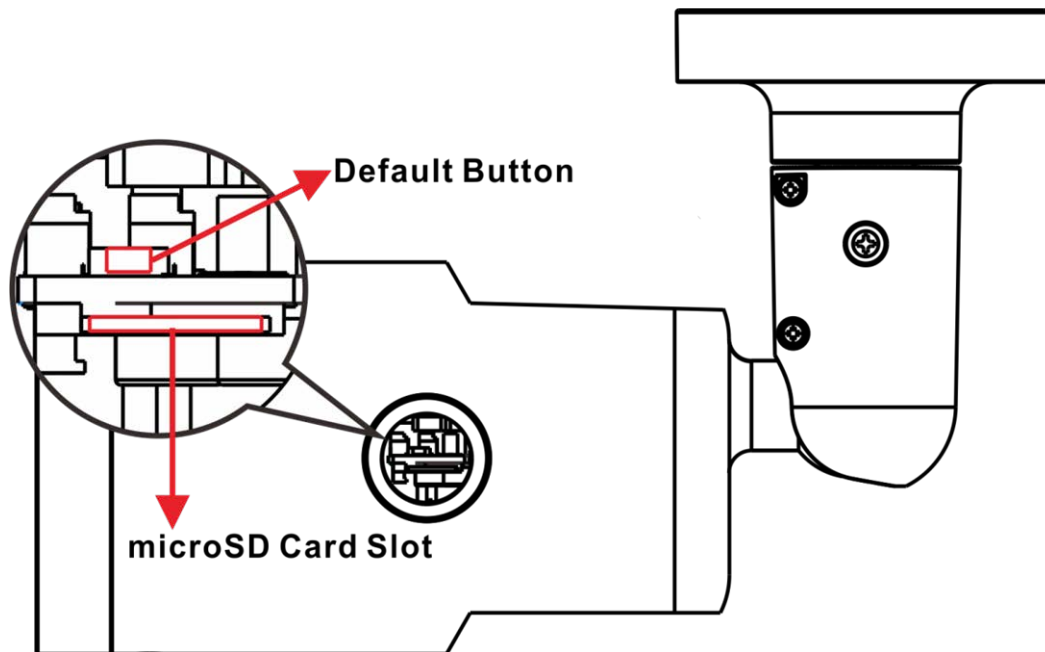

NOTE!

It is not recommended to record with the microSD card for 24/7 continuously, as it may not be able to support long term continuous data read/write. Please contact the manufacturer of the microSD card for information regarding the reliability and life expectancy.

Further Reading

[Manuals and Quick Installation documents](#)



[Technical Specifications](#)



[MOBOTIX MOVE Installation Hints](#)



[MOBOTIX Community](#)



Connection

This section contains the following information:

Camera Cabling	26
All-in-One Cable	26
Connecting Power	27
Connecting Ethernet Cable	27
Connect Alarm I/O	28
Waterproof Cable Connectors	28

Camera Cabling

Before users connect cables, make sure that all cables and the power adapter are placed in dry and well-waterproofed environments, e.g. waterproof boxes. The purpose is to prevent moisture accumulation inside the camera and moisture penetration into cables, which might lead to camera breakdown. Please refer to the following sections to complete camera connection.

NOTE! This camera must be installed by qualified personnel and the installation should conform to all local codes.

All-in-One Cable

The diagram below shows the All-in-One cable of the camera. Definition for each cable is also given as follows.

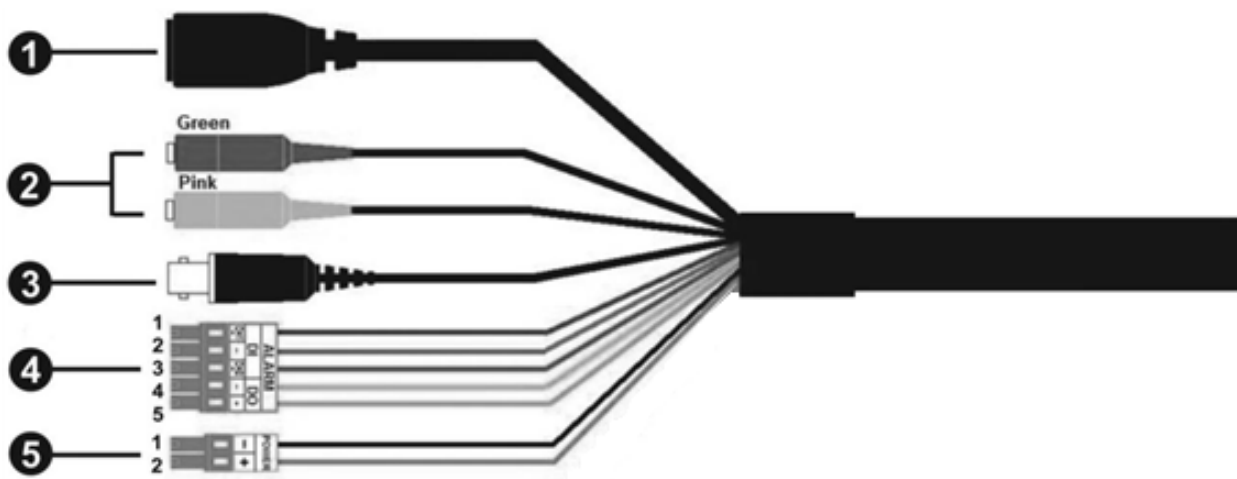

No	Cable	Pin	Definition	Remarks
1	RJ-45	-	For network and PoE connections	
2	Audio I/O	Green	Audio Out / Mic Out (Line Out)	Two-way audio transmission
		Pink	Audio In / Mic In (Line In)	
3	BNC	-	For analog video output	

No	Cable	Pin	Definition	Remarks	
4	Alarm I/O (5-pin Terminal Block)	1	Alarm In 2+	Alarm connection Do NOT connect external power supply to the alarm I/O connector of the IP camera!	
		2	Alarm In -		
		3	Alarm In 1+		
		4	Alarm Out -		
		5	Alarm Out +		
5	Power (AC24V) (2-pin Terminal Block)	1	AC 24V 1	DC 12V -	Power connection
		2	AC 24V 2	DC 12V +	

Connecting Power

Using Power over Ethernet (PoE)

Use a PoE switch (Class 0) and connect the Ethernet cable to the RJ-45 port of the camera.

Using AC or DC

To power up the camera, connect **either the AC or the DC** power adapter to the power connector of the camera and the power outlet.

CAUTION! Never connect both AC and DC power since **this will cause unforeseeable damage.**

Connecting Ethernet Cable

Ethernet Cable Connection

Connect one end of the Ethernet cable to the RJ-45 connector of the camera and plug the other end of the cable into the network switch or PC.

NOTE!

- The length of the Ethernet cable should not exceed 100 m/300 ft.
- Check the status of the link indicator and the activity indicator LEDs of the switch. If the LEDs are unlit, please check the LAN connection.
- In some cases, an Ethernet crossover cable may be needed when connecting the camera directly to the PC.

Ethernet Connector LEDs

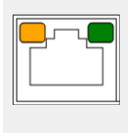

- Green **Link** LED indicates good network connection.
- Orange **Activity** LED flashes to indicate network activity.

Connect Alarm I/O

For alarm I/O connection, please connect alarm devices to the 5-pin terminal block of the All-in-One cable.

Waterproof Cable Connectors

Follow the steps below to waterproof the connectors of the All-in-One cable.

1. Connect the required devices to the All-in-One cable and coat the joints with silicone gel. There should be no gap between the connectors and the cables. For alarm I/O connector and power connector, make sure the side with wires attached is also sealed with silicone gel.
2. Seal the end of the rubber coating of the All-in-One cable as indicated in the figure on the right. Use enough silicone gel to fill in the hose and wrap around each wires; otherwise, waterproof function cannot be guaranteed.



Installation

This section contains the following information:

General Remarks	30
Ceiling/Wall Mounting	30

General Remarks

Read the instructions provided in this chapter thoroughly before installing the camera.

NOTE! This camera must be installed by qualified personnel and the installation must conform to all local codes.

NOTE! Observe the [MOBOTIX MOVE Installation Hints](#) document to ensure optimum performance of the camera features.

Ceiling/Wall Mounting

The camera can be installed directly on a wall or ceiling with the integrated adjustable Bracket Mount. Please note that the wall or ceiling must have enough strength to support the camera. Follow the steps below to install the camera.

CAUTION! To prevent damage when adjusting the camera's field of view, loosen all corresponding screws. Once finished, tighten these screws again.

NOTE! To ensure that the unit is not affected by vibration, twisting, etc. after adjusting the camera, properly tighten all mounting screws.

1. Place the camera at the installation location. On the ceiling/wall, mark the position of the two screw holes of the camera.



2. If the screw holes are blocked by the camera body, loosen the screw shown in the right figure but do not detach it. Then rotate the camera body to reach the screw holes.



3. At the center of the two marked holes, drill a 30 mm diameter (radius as 15 mm) cable entry hole. Then drill a hole slightly smaller than the supplied plastic screw anchor on each marked screw hole.
Thread the All-in-One cable of the camera through the cable entry hole. (Refer to chapter Camera Cabling for cable connections.)
4. Match the two screw holes of the camera with the plastic screw anchors at the installation location. Insert the plastic screw anchors into the two drilled holes, and then fasten the camera with the supplied M4x31 self-tapping screws.
5. Use a cross screwdriver to loosen the screw indicated in Figure 1, but do not detach it. Rotate the camera and point the camera to a desired direction. Then, tighten the screw. The camera joint will be fixed.



Figure 1

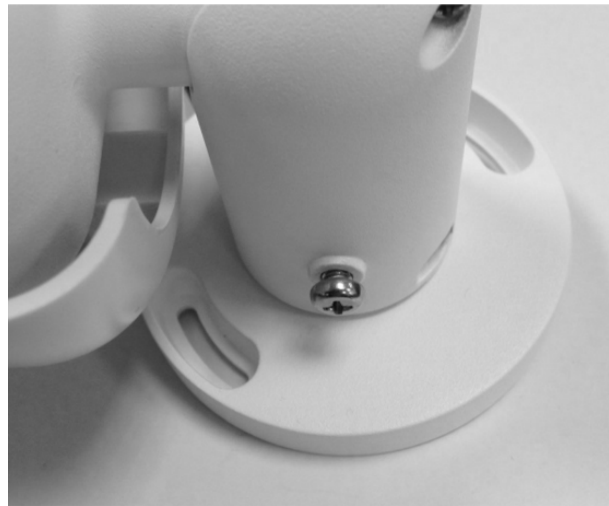

Figure 2

NOTE! If the camera joint is not tight enough for users, please fasten the supplied M5x10.5 standard screw into the hole as shown in Figure 2.

Configuration

This section contains the following information:

System Requirements for Operating the Camera	34
Accessing the Camera	34
Setting the Video Resolution	36
Exporting/Importing Configuration Files	37

System Requirements for Operating the Camera

To operate the IP camera via web browser, please ensure the PC is in good network connection and meets system requirements as described below.

Items	System Requirements
Personal Computer	Minimum: <ul style="list-style-type: none">▪ Intel® Core™ i5-2430M @ 2.4 GHz▪ 4 GB RAM Recommended: <ul style="list-style-type: none">▪ Intel® Core™ i7-870 @ 2.93 GHz▪ 8 GB RAM
Operating System	Windows 7 or later operating system
Web Browser	Any current web browser
Network Card	10Base-T (10 Mbps), 100Base-TX (100 Mbps) or 1000Base-T operation

NOTE! The ITE is to be connected only to PoE networks without routing to the outside plant or equivalent description.

Accessing the Camera

Accessing the Camera

The 2MP Vandal Bullet ALPR Camera supports all current browsers without requiring any additional plug-ins or add-ons (e.g. for H.264/H.265/MJPEG support).

Camera Login

The default IP address of the camera is: 10.x.x.x. By default, the camera starts as DHCP client and automatically tries to get an IP address from a DHCP server.

1. Enter the camera's IP address in the URL bar of the web browser and hit "Enter".
2. Enter the default username (**admin**) and password (**meinsm**).

NOTE! User names and passwords are case sensitive.

3. You will be prompted to set a new admin user password.

NOTE! The password can have between 6 and 14 characters (at least one digit, no special characters allowed).

4. After setting a new password, you will be prompted to log in again. Remember to use the new password.

Motorized Lens Models

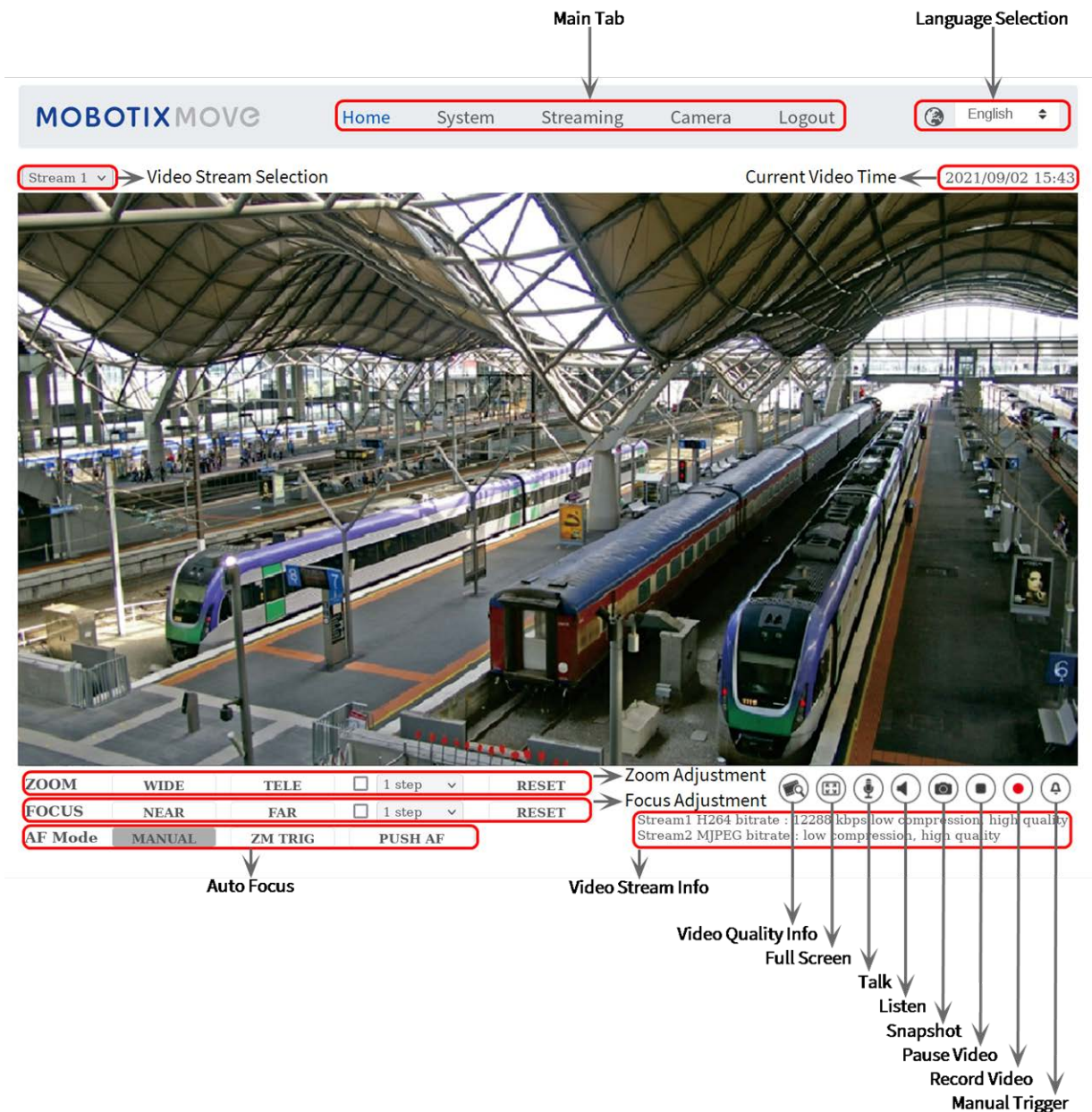

Fig. 3: Viewer Window

Zoom and Focus Adjustment

The live image will be displayed on the Home page when the camera is successfully accessed. If zoom or focus is not at the desired position, please use the function buttons on the Home page to adjust zoom and focus.

NOTE! Refer to section [Menu Reference, p. 39](#) of the Vandal Bullet WDR IP camera for more button function details.

Setting the Video Resolution

To edit the video configuration settings, select **Streaming > Video Configuration**.

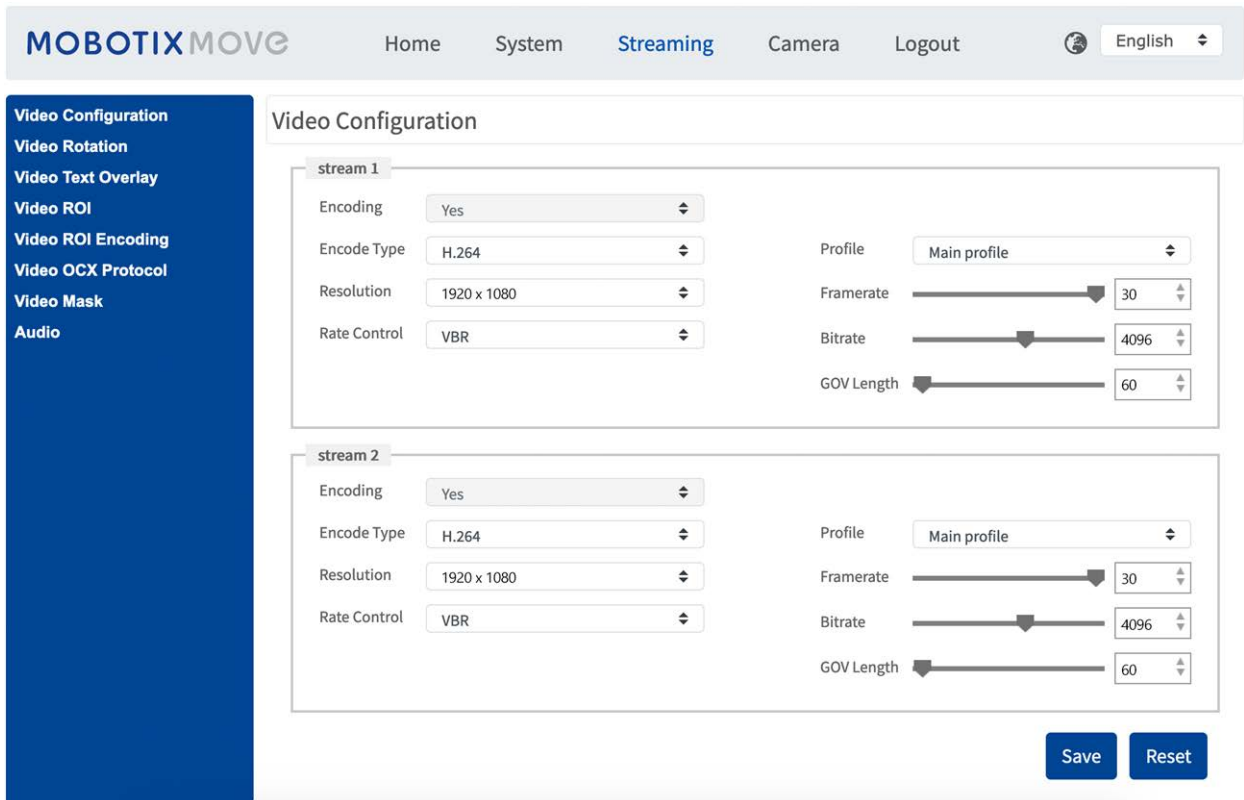

Default Resolution

The following table lists the default resolution of the camera.

IP Camera Model		Default Resolution
2MP Vandal Bullet ALPR Camera	WDR on/off	H.265/H.264: 1920 × 1080 (30 fps) +
Mx-VB1A-2-IR(-D)-ALPR		MJPEG: 1080p (30 fps)

Exporting/Importing Configuration Files

To export and import configuration files, you can access the Maintenance page on the user-friendly browser-based configuration interface.

To edit the Maintenance settings, select **System > Maintenance**.

You can export configuration files to a specified location and retrieve data by uploading an existing configuration file to the camera. This is especially convenient to make multiple cameras having the same configuration.

Export

You can save the system settings by exporting the configuration file (.bin) to a specified location for future use.

- Click on the **Export** button, and the popup File Download window will come out.
- Click on **Save** and specify a desired location for saving the configuration file.

Upload

To upload a configuration file to the camera, click on **Browse** to select the configuration file, and then click on the **Upload** button for uploading.

Menu Reference

This section contains the following information:

The Camera Menu	40
The “Home” Tab	41
The “System” Tab	45
The “Streaming” Tab	85
The “Camera” Tab	94
The “Logout” Tab	107
Appendix A: Installing UPnP Components	108
Appendix B: Converting IP Addresses from Decimal to Binary	108
Appendix C: List of Open/Closed IP Ports	110

The Camera Menu

The camera's Home Page shows these main tabs at the top:

The “Home” Tab, p. 41

You can monitor the live video of the targeted area.

The “System” Tab, p. 45

The administrator can set host name, system time, root password, network related settings, etc.

The “Streaming” Tab, p. 85

The administrator can configure video format, video compression, video OCX protocol, video frame rate and audio compression in this page.

The “Camera” Tab, p. 94

This tab contains the camera-related settings and is only available for the administrator and user accounts with camera control privileges.

The “Logout” Tab, p. 107

Click on the tab to log out of the camera system. Click on **Login** to log in again with a different user-name and password, for example.

The “Home” Tab

Click on the tab **Home** to access the Home Page. There are several function buttons on this page. Detailed information of each item is as described in the following section.

The screenshot shows the MOBOTIX MOVE Home page interface. At the top, there is a navigation bar with the MOBOTIX MOVE logo and a menu containing 'Home', 'System', 'Streaming', 'Camera', and 'Logout'. The 'Home' tab is highlighted. To the right of the menu is a language selection dropdown set to 'English'. Below the navigation bar, there is a 'Stream 1' dropdown menu for 'Video Stream Selection' and a 'Current Video Time' display showing '2021/09/02 15:43'. The main content area displays a live video stream of a train station platform with several high-speed trains. Below the video stream, there are several control panels:

- Zoom Adjustment:** Includes buttons for ZOOM, WIDE, TELE, a '1 step' dropdown, and a RESET button.
- Focus Adjustment:** Includes buttons for FOCUS, NEAR, FAR, a '1 step' dropdown, and a RESET button.
- AF Mode:** Includes buttons for MANUAL, ZM TRIG, and PUSH AF.
- Video Stream Info:** A box displaying 'Stream1 H264 bitrate : 12288 kbps, low compression, high quality' and 'Stream2 MJPEG bitrate : low compression, high quality'.
- Control Icons:** A row of icons for various functions: Video Quality Info, Full Screen, Talk, Listen, Snapshot, Pause Video, Record Video, and Manual Trigger.

 Arrows point from these labels to the corresponding elements in the interface.

NOTE! The function buttons on the Home page will vary for different camera models.

Function Items on Home Page

Multiple Languages Support

The 2MP Vandal Bullet ALPR Camera supports different languages for the browser interface, including German, English, Spanish, French, Italian, Japanese, Portuguese, Russian, Simplified Chinese, and Traditional Chinese.

Display Stream Selection

According to the streaming setting, you can choose the one stream to display from the drop-down menu.

Digital Zoom Control

In full screen mode you can use the digital PTZ by rotating the mouse wheel (for zooming in/out). Once you have zoomed in, you can drag the mouse in any direction to move the zoomed image.

Camera Info

Double-click on the live view pane, and the camera info window will pop up. You can instantaneously check the basic information of the camera, such as IP address, network status, video format, etc.

Video Quality

Click to show/hide the video quality information including bitrate and compression.

Full Screen

Use this button to switch the image display to full screen. Alternatively, right click on the **Live Video** pane and select **Fullscreen**.

To exit full screen mode:

- Tap **Esc** on the keyboard.
- Double-click on the **Live Video** pane.
- Right-click on the **Live Video** pane and select **Normal view**.

Talk (On/Off)

Talk function allows the local site talks to the remote site. Click on the button to switch it to On/Off. Users must select the suitable transmission mode under this path: Streaming > Audio to enable this function.

Listen (On/Off)

Click on **Listen** to mute/activate the audio. Users must select the suitable transmission mode under **Streaming > Audio** to enable this function.

NOTE! Both Talk and Listen functions are only available for user accounts that have been granted this privilege by the administrator. Please see the **Talk/Listen** section in **System > Security > User**, p. 47 for further details.

Snapshot

Click on the button and the JPEG snapshots will automatically be saved in the appointed place. The default place of saving snapshots is: C:\. To change the storage location, please see [File Location \(Snapshots and Web Recording\)](#), p. 81 for further details.

Live View (Pause/Restart)

Click on **Pause** to disable video streaming, the live video will be displayed as black. Click on **Restart** to show the live video again.

Record (On/Off)

Click on **Record** and the Live View through the web browser will be directly recorded to the specific location on the local hard drive, which could be configured in the File Location page. The default storage location for the web recording is: C:\. Please see [File Location \(Snapshots and Web Recording\)](#), p. 81 for further details.

Manual Trigger (On/Off)

Click on **Manual Trigger** to activate/deactivate the manual trigger. Please see [Manual Trigger](#), p. 73 for further details.

Zoom Adjustment

- **Wide/Tele**

Hold the **WIDE/TELE** button, and implement continuous zoom adjustment.

For zoom lens models, optical zoom in/out functions can also be implemented by moving the cursor to the live video pane and scrolling the mouse wheel in Normal View display mode.

- **Wide/Tele Steps**

Select a Wide/Tele step value from the drop-down menu to shift the zoom lens according to the define value.

- **Reset**

Click on **Reset**, and the zoom lens will be calibrated to the maximum wide end.

Manual Focus Adjustment

- **Near/Far**

Hold the **Near/Far** button, and implement continuous focus adjustment.

- **Near/Far Steps**

Select a Tele/Wide step value from the drop-down menu to shift the focus lens according to the defined value.

- **Reset**

Click on **Reset**, and the focus lens will first be reset to the maximum near end. Then the lens will be calibrated to a suitable position according to the monitoring environment.

Auto Focus (AF) Adjustment

- **Manual**

Click on **Manual**, and you can adjust the focus manually via the **Near / Far** buttons.

- **Zm Trig (Zoom Trigger AF)**

In this mode, AF is activated every time when zoom is adjusted.

- **Push AF**

The One Push AF function is for fixing the focus with one click.

The “System” Tab

The screenshot displays the 'System' configuration page in the MOBOTIXMOVE interface. On the left is a blue navigation menu with options like System, Security, Network, DDNS, Mail, FTP, HTTP, MxMessageSystem, Events, Storage Management, Recording, Schedule, File Location, View Information, Factory Default, Software Version, Software Upgrade, and Maintenance. The main content area is titled 'System' and contains the following settings:

- Host Name :** MegaPixelCamera
- Time zone :** GMT+01:00 Tunisia, France, Germany, Italy
- Enable daylight saving time**
- Time offset:** 01:00:00
- Start date:** Jan 1st, **Start time:** 00:00:00
- End date:** Jan 1st, **End time:** 00:00:00
- Time format:** yyyy/mm/dd
- Sync with computer time**
 - PC date:** 2021/09/02 [yyyy/mm/dd]
 - PC time:** 15:44:37 [hh:mm:ss]
- Manual**
 - Date:** 2016/04/01 [yyyy/mm/dd]
 - Time:** 00:00:00 [hh:mm:ss]
- Sync with NTP server**
 - NTP server:** 10.25.28.3

A **Save** button is located at the bottom of the configuration area.

NOTE! Only administrators can access the **System** configuration page.

System

To edit the system settings, select **System > System**.

Host Name

The name is for camera identification. If alarm actions (see [Triggered Actions \(Common to All Event Types\)](#), p. 63) are enabled and is set to send alarm messages by Mail/FTP, the host name entered here will be displayed in the alarm message.

Time Zone

Select the time zone from the drop-down menu according to the location of the camera.

Enable Daylight Saving Time

To enable DST, please check the item and then specify the time offset and the DST duration. The format for time offset is [hh:mm:ss]; for instance, if the amount of time offset is one hour, please enter “01:00:00” into the field.

Time format

Choose a time format (yyyy/mm/dd or dd/mm/yyyy) from the drop-down menu. The format of the date and time displayed above the live video window will be changed according to the selected format.

Sync with Computer Time

Select the item, and video date and time display will synchronize with the PC’s.

NOTE! Users MUST click on **Save** to confirm the setting. Otherwise, the time will not be synced.

Manual

The administrator can set video date and time manually. Entry format should be identical with the examples shown next to the enter fields.

Sync with NTP Server

Network Time Protocol (NTP) is an alternate way to synchronize the camera’s clock with a NTP server. Please specify the server that is wished to synchronize in the entry field. Then select an update interval from the drop-down menu. For further information about NTP, please open the web site www.ntp.org.

NOTE! The synchronization will be done every time the camera boots up.

Click on **Save** to apply and store the settings.

Security

To edit the security settings, select **System > Security**.

Click on **Security**, there will be a drop-down menu with tabs including **User**, **HTTPS**, **IP Filter**, and **IEEE 802.1X**.

User

To edit the user settings, select **System > Security > User**.

Admin Password

This item is for the administrator to reset password. Enter the new password in **Admin password** and **Confirm password**. The input characters will be displayed as dots for security purposes. Click on **Save** to confirm the changes. After the changes are confirmed, the web browser will ask the administrator to login again using the new password.

NOTE! The password can have between 6 and 14 characters (at least one digit, no special characters allowed).

Add User

This item is for the administrator to add new users. Enter the new user’s name in **User name** and the password in **User password**. Username can be up to 16 characters, and the password can have between 6 and 14 characters (at least one digit, no special characters). Click on **Add** to add the new user. The name of the new added user will be displayed in the **User name** drop-down menu under **Manage User**. There is a maximum of twenty user accounts.

Activate the boxes below to give privileges for functions:

- **I/O access**

This item supports fundamental functions that enable users to view the live video when accessing to the camera.

- **Camera control**

This item allows the appointed user to change camera parameters on the **Camera** and **Pan Tilt** setting page.

- **Talk/Listen**

This item allows the appointed user in the local site (camera site) to communicate with, for instance, the administrator in the remote site.

Manage User

- **Delete user**

Pull down the **User name** drop-down menu and select the username that is wished to be deleted. Click on **Delete** to remove the selected name.

- **Edit user**

Pull down the **User name** drop-down menu and select the username. Click on **Edit** and a popup window will appear. In the appeared window, enter the new user password and reset the privileges. Click on **Save** to confirm the changes. Then click on **Close** to complete the editing.

HTTP Authentication Setting

This setting allows secured connections between the IP camera and web browser by enforcing access controls to web resources. When users approach to the web browser, it'll ask for username and password, which protects the camera settings or live streaming information from snooping. There are two security models available: Basic and Digest. Refer to the descriptions below for more details.

- **Basic**

This mode can only provide basic protection for the connection security. There will still be risks for the password being intercepted.

- **Digest**

Digest mode is a safer option for protection. The password is sent in an encrypted format to prevent it from being stolen.

NOTE! Users MUST click on **Save** to apply the setting.

Streaming Authentication Setting

This setting provides security against unauthorized users from getting streaming via Real Time Streaming Protocol (RTSP). If the setting is enabled, users will be requested to enter user name and password before viewing the live streams. There are three security modes available: Disable, Basic and Digest. Refer to the descriptions below for more details.

- **Disable**

If disable mode is selected, there will be no security provided to against unauthorized access. Users will not be asked to input user name and password for authentication.

- **Basic**

This mode can only provide basic protection for the live streams. There will still be risks for the password being intercepted.

- **Digest**

Digest mode is a safer option for protection. The password is sent in an encrypted format to prevent it from being stolen.

NOTE! Users MUST click on **Save** to apply the setting.

Enable Account Lockout Function

The Account Lockout Function is to lock out an account when someone tries to log on unsuccessfully several times in a row. To protect user’s account, “Account Lockout Function” is activated when multiple login failures occur. Check the box **Enable Account Lockout Function** and enter the number of threshold and duration.

- **Threshold**

Threshold is a maximum number of login attempts, ranging from 5-20 times. The default value is 5 (attempts).

- **Duration**

Duration is the length of time that the account remains locked once the account lockout function is triggered, ranging from 1-60 minutes (default is 10 minutes).

Auto Log Off Setting

If **Enable log off timer** is enabled, the camera will log off the current user after the specified number of minutes without interaction have passed (default is 5 minutes).

HTTPS

To edit the HTTPS settings, select **System > Security > HTTPS**.

HTTPS allows secure connections between the camera and the web browser using **Secure Socket Layer (SSL)** or **Transport Layer Security (TLS)**, which protects camera settings and user-name/password information from snooping. It is required to install a self-signed or generated certificate or a CA-signed certificate for implementing HTTPS.

To use HTTPS on the camera, an HTTPS certificate must be installed. The HTTPS certificate can be obtained by either creating and sending a certificate request to a Certificate Authority (CA), by uploading a certificate, or by creating a self-signed HTTPS certificate.

NOTE! On MOBOTIX MOVE cameras, a certificate has already been installed. If you are not required to use a specific certificate (provided by your network administrator), you can use the pre-installed certificate.

Enable HTTPS

Select HTTPS secure mode from the **Enable HTTPS** drop-down list. Once enabled, choose one of the following modes.

- **Disable**
No security against unauthorized access. Users will not be asked to install new certificate.
- **HTTP & HTTPS**
Under this mode, HTTP & HTTPS secure connections are enabled.
- **HTTPS only**
Under this mode, the secure connection is ensured by HTTPS only.

Click on **Save** to apply and store the settings.

Install new certificate

Pull down the **Install new certificate** drop-down list and select the certificate type. Choose one from the following types.

- **Generate Self-signed Certificate**
Before a CA-issued certificate is obtained, you can create and install a self-signed certificate first.
Beneath **Generate Self-signed Certificate**, click on **Create** and provide the requested information as outlined under [Provide the Certificate Information, p. 51](#).

NOTE! The self-signed certificate does not provide the same high level of security as when using a CA-issued certificate.

- **Generate Certificate Request**
Click on **Generate Certificate Request** to create a certificate request for obtaining a signed certificate from CA. Provide the requested information as outlined under [Provide the Certificate Information, p. 51](#).
When the request is complete, the subject of the created request will be shown in the field. Click on **Properties** below the **Subject** field, copy the PEM-formatted request and send it to the selected CA.
When the signed certificate is returned, install it by uploading the signed certificate (see [Upload Private Key/Certificate, p. 51](#)).

Upload Private Key/Certificate

- Do one of the following:
 - If you have a *private key* file, click on **Browse** beneath **Private key** and select the private key file.
 - If you have a *certificate* file, click on **Browse** beneath **Certificate** and select the certificate file.
- Click on **Upload** and wait until the installation is finished.

Click on **Save** to apply and store the settings.

Provide the Certificate Information

To create a Self-signed HTTPS Certificate or a Certificate Request to CA, please enter the information as requested.

Information Item	Create Self Signed Certificate	Create Certificate Request
Country	✓	✓
State or Province	✓	✓
Locality	✓	✓
Organization	✓	✓
Organizational Unit	✓	✓
Common Name	✓	✓
Valid Days	✓	-

- **Country**
enter a two-letter combination code to indicate the country the certificate will be used in. For instance, type in “US” to indicate United States.
- **State or Province**
Enter the local administrative region.
- **Locality**
Enter other geographical information.
- **Organization**
Enter the name of the organization to which the entity identified in “Common Name” belongs.
- **Organization Unit**
Enter the name of the organizational unit to which the entity identified in “Common Name” belongs.

- **Common Name**

Indicate the name of the person or other entity that the certificate identifies (often used to identify the website).

- **Valid Days**

Enter the period in days (1 to 9999) to indicate the valid period of certificate.

Click on **OK** to save the Certificate Information after completing the setting.

IP Filter

To edit the IP filter settings, select **System > Security > IP Filter**.

With IP Filter, you can allow or deny specific IP addresses from accessing the camera.

Enable IP Filter

Check the box to enable the IP Filter function. Once enabled, the listed IP addresses (IPv4) in the **Filtered IP Addresses** list box will be allowed/denied to access the camera.

Select **Allow** or **Deny** from the drop-down menu and click on **Apply** to determine the IP filter behavior.

Add IP Address

Input IP address at the blank space below the **Filtered IP Address** list and click **Add**. The newly-added address will be shown in the list. Up to 256 IP address entries can be specified.

In addition, to filter a group of IP addresses, enter an address at the blank space followed with a slash and a number ranging from 1 to 31, e.g. 192.168.2.81/30. The number after the slash can define how many IP addresses will be filtered. For details, please refer to [Example: Filtering a Group of Consecutive IP Addresses](#), p. 52 below.

Delete IP Address

To remove an IP address from the **Filtered IP Address** list, select the address and click on **Delete**.

Example: Filtering a Group of Consecutive IP Addresses

1. Convert 192.168.2.81/30 to binary numbers (see [Appendix B: Converting IP Addresses from Decimal to Binary](#), p. 108). The binary numbers are 11000000.10101000.00000010.01010001. The number “30” after the slash is referring to the first 30 digits of the binary numbers.

2. Convert a few IP addresses before and after 192.168.2.81 to binary numbers. Then compare their first 30 digits with the binary numbers of 192.168.2.81.
 1. Convert 192.168.2.80 to binary numbers. The binary numbers are 11000000.10101000.00000010.01010000. The first 30 digits are the same with the binary numbers of 192.168.2.81, thus 192.168.2.80 will be filtered.
 2. Convert 192.168.2.79 to binary numbers. The binary numbers are 11000000.10101000.00000010.01001111. The first 30 digits are different with the binary numbers of 192.168.2.81, thus 192.168.2.79 will not be filtered. This also means the IP addresses before 192.168.2.79 will not be filtered. Therefore, you can stop converting the IP addresses before 192.168.2.79 to binary numbers.
 3. Repeat the same procedure in “a” with the IP addresses after 192.168.2.81. Stop when the situation occurs in “b” happened. Namely, the 30th digit of the binary numbers of IP address 192.168.2.84 is different, and will not be filtered.

As a result, the IP addresses 192.168.2.80 to 192.168.2.83 will be filtered when entering 192.168.2.81/30. The following table clearly shows the 30th digit of the binary numbers of IP addresses 192.168.79 and 192.168.84 are different from the others. Therefore, these two IP addresses will not be filtered.

IP Addresses	Binary Numbers
192.168.2.79	11000000.10101000.00000010.01001111
192.168.2.80	11000000.10101000.00000010.01010000
192.168.2.81	11000000.10101000.00000010.01010001
192.168.2.82	11000000.10101000.00000010.01010010
192.168.2.83	11000000.10101000.00000010.01010011
192.168.2.84	11000000.10101000.00000010.01010100

IEEE 802.1X

To edit the IEEE 802.1x settings, select **System > Security > IEEE 802.1X**.

The camera is allowed to access a network protected by 802.1X/EAPOL (Extensible Authentication Protocol over LAN).

Choose **On** to enable the IEEE 802.1X function.

Select one among the four protocol types: **EAP-MD5**, **EAP-TLS**, **EAP-TTLS** and **EAP-PEAP**.

Users need to contact with the network administrator for gaining certificates, user IDs and passwords.

CA Certificate

The CA certificate is created by the Certification Authority for the purpose of validating itself. Upload the certificate for checking the server’s identity.

Client Certificate/Private Key

Upload the Client Certificate and Private Key for authenticating the camera itself.

Settings

- **Identity**

Enter the user identity associated with the certificate. Up to 16 characters can be used.

- **Private Key Password**

Enter the password (maximum 16 characters) for user identity.

Enable IEEE 802.1X

Check the box to enable IEEE 802.1X.

Click on **Save** to apply and store the settings.

Network

To edit the network settings, select **System > Network**.

Click on **Network**, there will be a drop-down menu with tabs including **Basic**, **QoS**, **VLAN**, **SNMP**, and **UPnP**.

Basic

To edit the basic settings, select **System > Network > Basic**.

This setting page is for setting a new IP address for the camera, configuring other network-related parameters and activating IPv6 address (if the network supports it).

General

This setting menu is for configuring a new IP address for the camera. To setup an IP address, please find out the network type first. Contact the network provider for it. Then refer to the network type and follow the instructions to setup the IP address.

NOTE! If the network type is Point-to-Point Protocol over Ethernet (PPPoE), please obtain the PPPoE username and password from the network provider.

- **Get IP address automatically (DHCP)**

NOTE! You should copy the camera’s MAC address, which can be found on the label or on the package container of the camera. You will need the MAC address to obtain the IP address later on.

Select the item and click **Save** to confirm the new setting. A note for camera system reboot will appear. Click **OK** and the camera system will restart with a new IP address.

Check the network router or DHCP server to find the new IP address. If you cannot access the router or DHCP server, please contact your network administrator with a list of MAC addresses to fill in the corresponding IP addresses.

- **Use fixed IP address**

Select the item and insert the new IP address, e.g. 192.168.7.123. Note that the inserted IP address should be in the same LAN as the PC’s IP address. Then go to the Default gateway (explained later) blank and change the setting, e.g. 192.168.7.254. Click on **Save** to confirm the new setting. A note for system restart will appear, click **OK** and the camera system will restart. Wait for 15 seconds. The camera’s IP address in the URL bar will be changed, and users have to login again.

When using a static IP address to connect the camera, you can access the camera by inputting the IP address in the URL bar and hit **Enter** on the keyboard.

- **Use PPPoE**

For the PPPoE users, enter the PPPoE username and password into the enter fields.

Click on **Save** to apply and store the settings.

Advanced

The following introduces the camera’s Web Server port, RTSP port, MJPEG over HTTP port, and HTTPS port.

- **Web Server port**

The default web server port is 80. With the default web server port ‘80’, you can simply input the IP address of the camera in the URL bar of a web browser to connect the camera. When the web server port is changed to any number other than 80, users have to enter the camera’s IP address followed by a colon and the port number. For instance, a camera whose IP address is set as 192.168.0.100 and web server port as 8080 can be connected by entering “http://192.168.0.100:8080” in the URL bar.

- **RTSP port**

The default setting of RTSP Port is 554; the RTSP Port should be set as 554 or from the range 1024 to 65535.

■ MJPEG over HTTP port

This setting always uses port 80. To access the MJPEG stream over HTTP, open `http://<ip address>/live/stream<#>`, where <#> is the number of the stream you want to show.

■ HTTPS port

The default setting of HTTPS Port is 443; the HTTPS Port should be set as 443 or from the range 1024 to 65535.

NOTE! Please make sure the port numbers set above are not the same with each other; otherwise, network conflict may occur.

■ RTSP URL

When users use RTSP players to view the live streaming, the camera provides the flexibility to configure the streaming access name for stream 1 to stream 4. The streaming format is `rtsp://ip address:rtsp port/access name`. Take a camera whose IP address is set as 192.168.0.100 for example, if users enter “liveview.1” in the blank of stream 1 access name, the streaming address of stream 1 will be `rtsp://192.168.0.100:554/liveview.1`.

NOTE! The maximum length of the access name is 32 characters, and the valid characters are "A-Za-z0-9" and "!#\$%&'-.@^_~".

NOTE! For a list of default ports, please refer to [Appendix C: List of Open/Closed IP Ports, p. 110](#).

Click on **Save** to apply and store the settings.

IPv6 Address Configuration

If the network supports IPv6, you can check the box beside **Enable IPv6** and click **Save**. An IPv6 address will appear beside **Address**, and you can use it to connect to the camera.

Click on **Save** to apply and store the settings.

QoS

To edit the QoS (*Quality of Service*) settings, select **System > Network > QoS**.

QoS allows providing differentiated service levels for different types of traffic packets, which guarantees delivery of priority services especially when network congestion occurs. Adapting the Differentiated Services (DiffServ) model, traffic flows are classified and marked with DSCP (DiffServ CodePoint) values, and thus receive the corresponding forwarding treatment from DiffServ capable routers.

DSCP Settings

The DSCP value range is from 0 to 63. The default DSCP value is 0 (DSCP disabled). The camera uses the following QoS Classes:

- **Management DSCP**

NOTE! The class consists of HTTP traffic: Web browsing.

- **Stream 1~4 DSCP**

NOTE! You can set the Audio/Video DSCP of each stream.

- **Video DSCP**

The class consists of applications such as MJPEG over HTTP, RTP/RTSP and RTSP/HTTP.

- **Audio DSCP**

This setting is only available for the cameras that support audio.

NOTE! To enable this function, please make sure the switches/routers in the network support QoS.

Click on **Save** to apply and store the settings.

VLAN

To edit the VLAN settings, select **System > Network > VLAN**.

Check the box **Enable VLAN** to activate the VLAN function. Enter the VLAN ID. The allowed range of VLAN ID is from 1 to 4095. The default value is 20.

CoS

CoS stands for *Class of Service*. The higher the value of CoS is, the better transmission performance will be. The value also determines the transmission priority among the following three classes:

- **Live Video**

The value range is from 0 to 7.

- **Live Audio**

The value range is from 0 to 7.

- **Management**

The value range is from 0 to 7.

SNMP

To edit the SNMP (Simple Network Management Protocol) settings, select **System > Network > SNMP**.

With Simple Network Management Protocol (SNMP) support, the camera can be monitored and managed remotely by the network management system.

SNMP v1/v2

- **Enable SNMP v1/v2**

Select the version of SNMP to use by checking the box.

- **Read Community**

Specify the community name that has read-only access to all supported SNMP objects. The default value is “public”.

- **Write Community**

Specify the community name that has read/write access to all supported SNMP objects (except read-only objects). The default value is “private”.

SNMP v3

SNMP v3 supports an enhanced security system that provides protection against unauthorized users and ensures the privacy of the messages. Users will be requested to enter security name, authentication password and encryption password while setting the camera connections in the network management system. With SNMP v3, the messages sent between the cameras and the network management system will be encrypted to ensure privacy.

- **Enable SNMP v3**

Enable SNMP v3 by checking the box.

- **Security Name**

The maximum length of the security name is 32 characters.

NOTE! The valid characters are "A-Za-z0-9" and "!#\$%&'-.@^_~".

- **Authentication Type**

There are two authentication types available: MD5 and SHA. Select **SHA** for a higher security level.

- **Authentication Password**

The authentication password must be 8 characters or more. The input characters will be displayed as dots for security purposes.

NOTE! The valid characters are "A-Za-z0-9" and "!#\$%&'-.@^_~".

- **Encryption Type**

There are two encryption types available: DES and AES. Select **AES** for a higher security level.

- **Encryption Password**

The minimum length of the encryption password is 8 characters and the maximum length is 512 characters. The input characters will be displayed as dots for security purposes. The encryption password can also be left blank. However, the messages will not be encrypted to protect privacy.

NOTE! The valid characters are "A-Za-z0-9" and "!#\$%&'-.@^_~".

Traps for SNMP v1/v2/v3

Traps are used by the camera to send messages to a management system for important events or status changes.

- **Enable Traps**

Check the box to activate trap reporting.

- **Trap address**

Enter the IP address of the management server.

- **Trap community**

Enter the community to use when sending a trap message to the management system.

Trap Option

- **Warm Start**

A Warm Start SNMP trap signifies that the SNMP device, i.e. IP camera, performs software reload.

Click on **Save** to apply and store the settings.

UPnP

To edit the UPnP settings, select **System > Network > UPnP**.

UPnP Setting

- **Enable UPnP**

When the UPnP is enabled, whenever the camera is presented to the LAN, the icon of the connected cameras will appear in My Network Places to allow for direct access.

NOTE! To enable this function, please make sure the UPnP component is installed on the computer. Please see [Appendix A: Installing UPnP Components, p. 108](#) for the installation procedure.

- **Enable UPnP port forwarding**

When the UPnP port forwarding is enabled, the camera is allowed to open the web server port on the router automatically.

NOTE! To enable this function, please make sure that the router supports UPnP and it is activated.

- **Friendly name**

Set a name for the camera for identity.

Click on **Save** to apply and store the settings.

OpenVPN

This camera uses [OpenVPN](#) to implement a virtual private network (VPN). A VPN establishes secure point-to-point or site-to-site connections between networks and computers (e.g. for remote workers). Your VPN gateway administrator will provide the values for the settings below.

- **OpenVPN**

Select **Enabled** to activate VPN.

- **Server address**

Enter the IP address or DNS name of the VPN gateway you want to use.

- **Server port**

Enter the server port of the specified VPN gateway.

- **Communication protocol**

Select the type of protocol for the specified VPN gateway.

- **Cipher**

Select the cipher that is being used to encode the network data.

- **CA certificate**

Click on **Browse** to upload a new certification authority (CA) certificate file (ask your VPN administrator for details).

- **Client certificate**

Click on **Browse** to upload a new client certificate file (ask your VPN administrator for details).

- **Private key**

Click on **Browse** to upload a new private key file (ask your VPN administrator for details).

Click on **Save** to apply and store the settings.

Bonjour

Bonjour (also known as [Zero-configuration networking](#) or *zeroconf*) is a method for establishing automatic peer-to-peer networks (i.e. without dedicated network services, such as DHCP or DNS servers).

Activate **Enable Bonjour** to use this feature.

Click on **Save** to apply and store the settings.

DDNS

To edit the DDNS settings, select **System > DDNS**.

Dynamic Domain Name System (DDNS) allows a host name to be constantly synchronized with a dynamic IP address. In other words, it allows those using a dynamic IP address to be associated to a static domain name so others can connect to it by name.

- **Enable DDNS**

Check the item to enable DDNS.

- **Provider**

Select one DDNS host from the provider list.

- **Host name**

Enter the registered domain name in the field.

- **Username/E-Mail**

Enter the username or E-mail required by the DDNS provider for authentication.

- **Password/Key**

Enter the password or key required by the DDNS provider for authentication.

Mail

To edit the mail settings, select **System > Mail**.

The administrator can send an E-mail via Simple Mail Transfer Protocol (SMTP) when an alarm is triggered. SMTP is a protocol for sending E-mail messages between servers. SMTP is a relatively simple, text-based protocol, where one or more recipients of a message are specified and the message text is transferred.

Two sets of SMTP can be configured. Each set includes SMTP Server, Account Name, Password and E-mail Address settings. For SMTP server, contact the network service provider for more specific information.

Click on **Save** when finished. Then, please click on **Test** to check the connection between the camera and the specified SMTP server.

FTP

To edit the FTP settings, select **System > FTP**.

The administrator can set the camera to send the alarm messages to a specific File Transfer Protocol (FTP) site when an alarm is triggered. You can assign alarm message to up to two FTP sites. Enter the FTP details, which include server, server port, username, password and remote folder, in the fields.

Click on **Save** when finished. Then, please click on **Test** to check the connection between the camera and the specified FTP server.

HTTP

To edit the HTTP settings, select **System > HTTP**.

An HTTP Notification server can listen for the notification messages from the cameras by triggered events. Enter the HTTP details, which include server name (for instance, <http://192.168.0.100/admin.php>), username, and password in the fields. **Alarm** triggered and **Motion Detection** notifications can be sent to the specified HTTP server.

Click on **Save** to apply and store the settings.

NOTE! Please see **Events > Application > Send HTTP Notification**, p. 66 for the HTTP notification settings.

Events (Alarm Settings)

To edit the events settings, select **System > Events**. You will see these sections:

- **Application**
- **Motion Detection**
- **Network Failure Detection**
- **Tampering**
- **Periodical Event**
- **Manual Trigger**
- **Audio Detection**
- **ALPR**

Triggered Actions (Common to All Event Types)

The following alarm actions can be triggered by the camera when it detects the corresponding event.

NOTE! Depending on the camera’s features and specific settings, some actions may not be available (e.g. FTP is only available if an FTP site has been specified).

- **Enable Alarm Output (high/low)**

Select these items to enable alarm relay outputs.

- **IR Cut Filter**

Select the item and the IR cut filter (ICR) of the camera will be removed (on) or blocked (off) when alarm input is triggered. This function is only available for models with IR cut filter.

NOTE! The [IR Function, p. 101](#) could not be set as **Auto** mode if this triggered action is enabled.

- **Send Alarm Message by FTP/E-Mail**

The administrator can select whether to send an alarm message by FTP and/or E-mail when audio is detected.

■ Upload Image by FTP

Select this item and the administrator can assign an FTP site and configure various parameters. When audio is detected, event images will be uploaded to the appointed FTP site. Note that to implement this function, one of the streaming MUST be set as MJPEG; otherwise, this function will be grayed out and cannot be accessed.

The **Pre-trigger buffer** function allows users to check what happened to cause the trigger. The **Pre-trigger buffer** frame rate could be pre-determined. On the other hand, **Post-trigger buffer** is for users to upload certain amount of images after audio event occurs.

NOTE! The **Pre-trigger buffer** generally ranges from 1 to 20 frames. However, the range will change accordingly if the frame rate of MJPEG on **Streaming > Video Configuration** is 6 or lower.

Check the box **Continue image upload** to upload the triggered images during certain time or keep uploading until the trigger is off. Select **Upload for __sec** and enter the duration in the blank. The images of the duration will be uploaded to FTP when the audio event occurs. The setting range is from 1 to 99999 sec. Select **Upload while the trigger is active** to make the images keep being uploaded to FTP during the trigger active until the event stops. Set the Image frequency as the upload frame rate. The setting range is from 1 to 15 frames per second.

NOTE! Make sure FTP configuration has been completed. Refer to section FTP for further details.

■ **Upload Image by E-Mail**

Select this item and the administrator can assign an E-mail address and configure various parameters. When audio is detected, event images will be sent to the appointed E-mail address. Note that to implement this function, one of the streaming MUST be set as MJPEG; otherwise, this function will be grayed out and cannot be accessed.

The **Pre-trigger buffer** function allows users to check what happened to cause the trigger. The **Pre-trigger buffer** frame rate could be pre-determined. On the other hand, **Post-trigger buffer** is for users to upload certain amount of images after the audio event occurs.

NOTE! The **Pre-trigger buffer** generally ranges from 1 to 20 frames. However, the range will change accordingly if the frame rate of MJPEG on **Streaming > Video Configuration** is 6 or lower.

Check the box **Continue image upload** to upload the triggered images during certain time or keep uploading until the trigger is off. Select **Upload for __sec** and enter the duration in the blank. The images of the duration will be uploading by E-mail when the audio event occurs. The setting range is from 1 to 99999 sec. Select **Upload while the trigger is active** to make the images keep being uploaded to E-mail during the trigger active until the event stops. Set the Image frequency as the upload frame rate. The setting range is from 1 to 15 frames per second.

NOTE! Make sure SMTP configuration has been completed. Refer to section Mail for further details.

■ Upload Image to SD Card

Select this item, and then the images will be uploaded to the SD card periodically. Note that to implement this function, one of the streaming MUST be set as MJPEG; otherwise, this function will be grayed out and cannot be accessed.

The **Pre-trigger buffer** function can define how many images to be uploaded before the triggered moment. The **Post-trigger buffer** function can define how many images to be uploaded after the triggered moment.

NOTE! The **Pre-trigger buffer** generally ranges from 1 to 20 frames. However, the range will change accordingly if the frame rate of MJPEG on **Streaming > Video Configuration** is 6 or lower.

NOTE! Before implementing **Upload Image to SD Card**, please make sure that the SD Card is properly detected and installed. Refer to **Storage Management > SD Card > Device Information** for further details.

Send message by MxMessageSystem

Check this item and select a message to be sent to the MxMessageSystem accordingly. If required, add custom JSON parameters to the message.

■ Send HTTP Notification

Check this item, select the destination HTTP address, and specify the parameters for event notifications by **Audio Detection** triggered. When an alarm is triggered, the notification can be sent to the specified HTTP server.

For instance, if the custom parameter is set as “action=1&group=2”, and the HTTP server name is “http://192.168.0.1/admin.php”, the notification will be sent to HTTP server as “http://192.168.0.1/admin.php? action=1&group=2” when alarm is triggered.

Send message by MxMessageSystem

Check this item and select a message to be sent to the MxMessageSystem accordingly. If required, add custom JSON parameters to the message.

- **Record Video Clip**

Check this item and select a video recording storage type, **SD Card** or **NAS** (Network-Attached Storage). The Audio Detection recording will be stored in microSD/SD card or the NAS when audio is detected.

The **Pre-trigger buffer** recording function allows users to check what happened to cause the trigger. The pre-trigger buffer time range is from 1 to 3 sec. Select **Upload for __ sec** to set the recording duration after audio is triggered. The setting range is from 1 to 99999 sec. Select **Upload while the trigger is active** to record the triggered video until the trigger is off.

NOTE! Please make sure the local recording (with microSD/SD card) or the remote recording (with NAS) is activated so that this function can be implemented. Refer to section Recording for further details.

File Name

Enter a file name in the blank, e.g. image.jpg. The uploaded image’s file name format can be set in this section. Please select the one that meets the requirements.

- **Add date/time suffix**

File name: imageYYMMDD_HHNNSS_XX.jpg

Y: Year, M: Month, D: Day

H: Hour, N: Minute, S: Second

X: Sequence Number

- **Add sequence number suffix (no maximum value)**

File name: imageXXXXXXXX.jpg

X: Sequence Number

- **Add sequence number suffix up to # and then start over**

File Name: imageXX.jpg

X: Sequence Number

NOTE! The file name suffix will end at the number being set. For example, if the setting is up to “10”, the file name will start from 00, end at 10, and then start all over again.

- **Overwrite**

The original image in the FTP site will be overwritten by the new uploaded file with a static file name.

Click on **Save** to apply and store the settings.

Application

To edit the application settings, select **System > Events > Application**.

The camera supports one alarm input and one relay output for cooperation with alarm system to catch event images. Refer to alarm pin definition below to connect alarm devices to the camera if needed.

Alarm Switch

The default setting for the Alarm Switch function is **Off**. Enable the function by selecting **On**. You can also activate the function according to the schedule previously set in the **Schedule** setting page. Select **By schedule** and click **Please select...** to choose the desired schedule from the drop-down menu.

Alarm Type

Select an alarm type, **Normal close** or **Normal open**, that corresponds with the alarm application.

Triggered Action

See the section [Triggered Actions \(Common to All Event Types\)](#), p. 63 for information about the various actions that can be triggered.

Click on **Save** to apply and store the settings.

Motion Detection

To edit the motion detection settings, select **System > Events > Motion Detection**.

Motion Detection function allows the camera to detect suspicious motion and trigger alarms by comparing sampling pixels in the detection area of two consecutive live images. When motion volume in the detection area reaches/exceeds the determined sensitivity threshold value, the alarm will be triggered.

The function supports up to 4 sets of Motion Detection Settings. Settings can be chosen from the Motion Detection drop-down menu.

Motion Detection

By default, motion detection is **Off**. Select **On** to enable this feature.

You can also activate the function according to the schedule previously set in the **Schedule** setting page. Select **By schedule** and click **Please select...** to choose the desired schedule from the drop-down menu.

Motion Region Paint

The camera divides the detection area into 1200 (40x30) detection grids; you can draw the motion detection region using the paintbrush.

Check the box **Enable brush** and select the brush size, 1x1, 3x3 or 5x5. Then, left click and drag the mouse cursor to draw the preferred detection region. To erase the drawn detection region, left click and drag the mouse cursor on the colored grids.



Motion Detection Setting

Users could adjust various parameters of Motion Detection in this section.

- **Sampling pixel interval [1-10]:**

This item is used to examine the differences between two frames. You can configure the interval of sampling pixel. The default value is 1. For instance, if users set the interval as 3, IP camera system will take one sampling pixel from every 3 pixels of each row and each column in detection area (refer to the figure below). The alarm will be triggered when differences are detected.

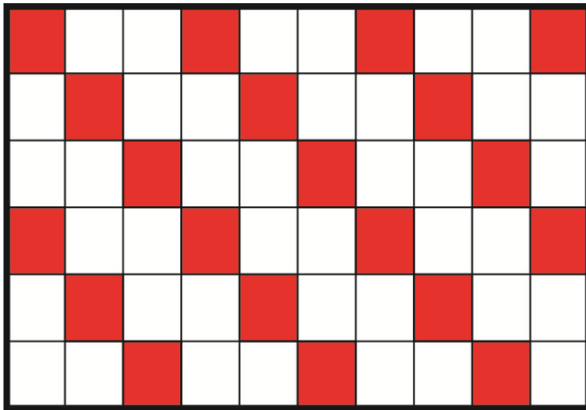

- **Detection level [1-100]:**

You can configure detection level for each sampling pixel. Detection level is how much the camera can accept the differences between two sampling pixels. The smaller the value is, the more minor motions it detects. The default level is 10.

- **Sensitivity level [1-100]:**

The default level is 80, which means if 20% or more sampling pixels are detected differently, system will detect motion. The bigger the value, the more sensitive it is. Meanwhile, when the value is bigger, the red horizontal line in the motion indication window will be lower accordingly.

- **Time interval (sec) [0-7200]:**

The value is the interval between each detected motion. The default interval is 10.

Motion Indication Bar

When Motion Detection function is activated and the motion is detected, the signals will be displayed on the motion indication bar. The motion indication bar will go green or red when there is any motion occurrence in the detection region.

Green suggests the occurring motion is detected and does not exceed the threshold of detection level and sensitivity level. No alarms will be triggered.



Red suggests the ongoing motion exceeds the threshold of detection level and sensitivity level. The alarm will be triggered.



Triggered Action

See the section [Triggered Actions \(Common to All Event Types\)](#), p. 63 for information about the various actions that can be triggered.

Click on **Save** to apply and store the settings.

Network Failure Detection

To edit the network failure detection settings, select **System > Events > Network Failure Detection**.

Network Failure Detection allows the camera to ping another IP device (e.g. NVR, VSS, Video Server, etc.) within the network periodically and generates some actions in case of network failure occurs, for instance, a Video Server is somehow disconnected.

Being capable of implementing local recording (through microSD/SD card) or remote recording (via NAS) when network failure happens, the camera can be a backup recording device for the surveillance system.

Detection Switch

The default setting for the Detection Switch function is **Off**. Enable the function by selecting **On**.

You can also activate the function according to the schedule time that is previously set in the **Schedule** setting page. Select **By schedule** and click **Please select...** to choose the desired schedule from the drop-down menu.

Detection Type

Input the IP device address and the period of ping time to ping. The camera will ping the IP device every N minute(s). If it fails for up to three times, the alarm will be triggered. The ping time setting range is from 1 to 99 min.

Triggered Action

See the section [Triggered Actions \(Common to All Event Types\)](#), p. 63 for information about the various actions that can be triggered.

Click on **Save** to apply and store the settings.

Tampering

To edit the tampering settings, select **System > Events > Tampering**.

Tampering Alarm function helps the IP camera against tampering, such as deliberate redirection, blocking, paint spray, and lens cover, etc., through video analysis and reaction to such events by sending out notifications or uploading snapshots to the specified destination(s).

Detection of camera tampering is achieved by measuring the differences between the older frames of video (which are stored in buffers) and more recent frames.

Tampering Alarm

The default setting for the Tampering Alarm function is **Off**. Enable the function by selecting **On**. You can also activate the function according to the schedule previously set in the **Schedule** setting page. Select **By schedule** and click **Please select...** to choose the desired schedule from the drop-down menu.

Tampering Duration

Minimum Tampering Duration is the time for video analysis to determine whether camera tampering has occurred. Minimum Duration could also be interpreted as defining the Tampering threshold; longer duration represents higher threshold. Settable Tampering Duration time range is from 10 to 3600 sec. The Default value is 20 sec.

Triggered Action

See the section [Triggered Actions \(Common to All Event Types\)](#), p. 63 for information about the various actions that can be triggered.

Click on **Save** to apply and store the settings.

MxMessageSystem Event

To edit the MxMessageSystem Event settings, select **System > Events > MxMessageSystem Event**.

MxMessageSystem Alarm function can trigger an action if a notification by the MxMessageSystem is received.

MxMessageSystem Alarm

The default setting for the MxMessageSystem Alarm function is **Off**. Enable the function by selecting **On**. You can also activate the function according to the schedule previously set in the **Schedule** setting page. Select **By schedule** and click **Please select...** to choose the desired schedule from the drop-down menu.

MxMessageSystem Setting

- **Message Path/Name:** Enter the message path of the MxMessage which should trigger an action. Minimum Tampering Duration is the time for video analysis to determine whether camera tampering has occurred. Minimum Duration could also be interpreted as defining the Tampering threshold; longer duration represents higher threshold. Settable Tampering Duration time range is from 10 to 3600 sec. The Default value is 20 sec.
- **Action Duration:** Set a time period in seconds after which a triggered action such as video recording is to be ended.

Triggered Action

See the section [Triggered Actions \(Common to All Event Types\)](#), p. 63 for information about the various actions that can be triggered.

Click on **Save** to apply and store the settings.

Periodical Event

To edit the periodical event settings, select **System > Events > Periodical Event**.

With Periodical Event setting, you can set the camera to upload images periodically to an FTP site or an E-mail address. For example, if the time interval is set to 60 seconds, the camera will upload images to the FTP site or the E-mail address every 60 seconds. The images to be uploaded are the images before and after the triggered moment. You can define how many images to be uploaded in the **Triggered Action** section of this setting page.

Periodical Event

The default setting for the Periodical Event function is **Off**. Enable the function by selecting **On**.

Time Interval

The default value of the time interval is 60 seconds. The setting range of the time interval is from 60 to 3600 seconds.

Triggered Action

See the section [Triggered Actions \(Common to All Event Types\)](#), p. 63 for information about the various actions that can be triggered.

Click on **Save** to apply and store the settings.

Manual Trigger

To edit the manual trigger settings, select **System > Events > Manual Trigger**.

With Manual Trigger setting, the current image(s) or video can be uploaded to the appointed destination, such as an FTP site or an E-mail address. The administrator can specify the triggered actions that will take when the users switch the Manual Trigger button to ON. All options are listed as follows.

Manual Trigger

The default setting for the Manual Trigger function is **Off**. Enable the function by selecting **On**. After the Manual Trigger function is enabled, click the Manual Trigger button on the Home page to start uploading data. Click again to stop uploading.

Triggered Action

See the section [Triggered Actions \(Common to All Event Types\)](#), p. 63 for information about the various actions that can be triggered.

Click on **Save** to apply and store the settings.

Audio Detection

To edit the audio detection settings, select **System > Events > Audio Detection**.

Audio Detection function allows the camera to detect audio and trigger alarms when audio volume in the detected area reaches or exceeds the determined sensitivity threshold value.

NOTE! Audio Detection function is only available for models equipped with Audio I/O function.

Audio Detection

In Audio Detection Setting, the default setting for the Audio Detection function is **Off**. Enable the function by selecting **On**.

Audio Detection Setting

Users could adjust various parameters of Audio Detection in this section.

- **Detection level [1-100]:**

The item is to set detection level for each sampling volume; the smaller the value, the more sensitive it is. The default level is 10.

- **Time interval (sec) [0-7200]:**

The value is the interval between each detected audio. The default interval is 10.

Triggered Action

See the section [Triggered Actions \(Common to All Event Types\)](#), p. 63 for information about the various actions that can be triggered.

Click on **Save** to apply and store the settings.

ALPR

Click on this menu item to access the camera’s ALPR (*Automatic License Plate Recognition*) features. Since this system brings its own operational environment, you can use one of the following methods to work with ALPR:

- Select **ALPR** from **System > Events**.
- Open `http://<IPAddress>/mobotix/index.html`

NOTE!

- To understand how the ALPR system is working, it is highly recommended to read the entire section [ALPR Best Practices, p. 113](#).

Storage Management

To edit the storage management settings, select **System > Storage Management**.

Click on **Storage Management**, there will be a drop-down menu with tabs including **SD Card** and **Network Share**.

SD Card

To edit the settings for the SD card, select **System > Storage Management > SD Card**.

You can implement local recording to the microSD/SDHC/SDXC card with up to 1 TB capacity.

This page shows the capacity information of the storage medium and a recording list with all the recording files saved on the memory card. You can also format the storage medium and implement automatic recording cleanup through the setting page.

To implement recording on a storage medium, please go to the **Recording** page (see [Recording, p. 79](#)).

NOTE! Please format the storage medium when using it for the first time. Formatting will also be required when a storage medium is being used on one camera and later transferred to another camera with different software platform.

It is not recommended to record on microSD/SD cards for 24/7 continuously, as it may not be able to support long term continuous data read/write. Please contact the manufacturer of the microSD/SD card for information regarding reliability and life expectancy.

Device Information

After the storage medium is inserted into the camera, the card information such as memory capacity and status will be shown at **Device Information**.

Recording Source

Select a video stream to set as the recording source. The default format of the video stream is **Stream 1**. Select a preferred stream from the drop-down list.

Click on **Save** to apply and store the settings.

Recording Filename Format

Select a format as the recording file name format. The default recording file name format is **Start time only**. Select a preferred format from the drop-down list.

Click on **Save** to apply and store the settings.

Device Setting

Click on **Format** to format the storage medium.

Two file systems are provided: **vfat** (default) and **ext4**. It is recommended to select **ext4** for steady and better performance.

Disk Cleanup Setting

Check **Enable automatic disk cleanup** and specify the time **1~999 day(s) or 1~142 week(s)** and storage limits **1~99% full** to configure disk cleanup settings.

Click on **Save** to apply and store the settings.

Recording List

Enter the period in the date fields and click on **Search**. Select **Video / JPEG**, and then each video/image file on the storage medium will be listed in the recording list. The maximum file size is 60 MB/per file.

When the recording mode is set as **Always** (consecutive recording) and the storage medium recording is also allowed to be enabled by events triggered, once events occur, the system will immediately implement events recording to the memory card. After the recording of the events are finished, the camera will return to the regular recording mode.

- **Remove**

To remove a file, select the file first, and then click **Remove** button.

■ **Sort**

Click on **Sort**, and the files in the Recording list will be listed in name and date order. The capital letter at the beginning of a name indicates the type of recording:

Initial	Recording Type	Initial	Recording Type
A	Alarm	S	Periodical Event
M	Motion	R	Regular Recording
N	Network Failure	V	Manual Trigger
T	Tampering	U	Audio Detection

■ **Download**

To open/download a video clip/image, select the file first, then click on **Download** below the **Recording** list. The selected file window will pop up. Click on the AVI/JPEG file to download the file to the specified location.

Network Share (NAS)

To edit the network share settings, select **System > Storage Management > Network Share**.

You can store the recording videos to a network share folder, or NAS (Network-Attached Storage). A NAS device is used for data storage and data sharing via network. This page displays the capacity information of the network device and a recording list with all the recording files saved on the network device. You can also format the NAS and implement automatic recording cleanup through the setting page.

Device Information

When a NAS is successfully installed, the device information such as the memory capacity and status will be shown at **Device Information**.

Storage Setting

The administrator can set the camera to send the alarm messages to a specific NAS site when an alarm is triggered. Enter the network device details, which include host (the IP of the NAS), share (the folder name of the NAS), user name, and password, in the fields.

Click on **Save** to apply and store the settings.

Storage Tools

Click on **Format** to format the NAS.

Recording Source

Select a video stream to set as the recording source. The default format of the video stream is

Stream 1. Select a preferred stream from the drop-down list.

Click on **Save** to apply and store the settings.

Recording Filename Format

Select a format to set as the recording file name format. The default recording file name format is

Start time only. Select a preferred format from the drop-down list

Click on **Save** to apply and store the settings.

Disk Cleanup Setting

Check **Enable automatic disk cleanup** and specify the time **1~999 day(s) or 1~142 week(s)** and storage limits **1~99% full** to configure disk cleanup settings.

Click on **Save** to confirm the settings.

Recording List

Each video file on the Network Share will be listed in the Recording list. The maximum file size is 60 MB/per file.

When the recording mode is set as **Always** (consecutive recording) and the NAS recording is also allowed to be enabled by events triggered, once events occur, the system will immediately implement events recording to NAS. After the recording of the events are finished, the camera will return to the regular recording mode.

- **Remove**

To remove a file, select the file first, and then click on **Remove**.

- **Sort**

Click on **Sort**, and the files in the Recording list will be listed in name and date order.

The capital letter at the beginning of a name indicates the type of recording:

Initial	Recording Type	Initial	Recording Type
A	Alarm	S	Periodical Event
M	Motion	R	Regular Recording
N	Network Failure	V	Manual Trigger
T	Tampering	U	Audio Detection

■ Download

To open/download a video clip, select the file first, and then click on **download** below the Recording list field. The selected file window will pop up. Click on the AVI file to directly play the video in the player or download it to a specified location.

Recording

To edit the recording settings, select **System > Recording**.

In the **Recording** setting page, you can specify the recording schedule that fits the present surveillance requirement.

Recording

Recording Storage

SD Card
 Network Share

Recording Schedule

Disable
 Always
 Only during time frame

	Weekday	Start time	Duration
1	O - - - - - O	00:00	24:00
2	- - - - -	----	----
3	- - - - -	----	----
4	- - - - -	----	----
5	- - - - -	----	----
6	- - - - -	----	----
7	- - - - -	----	----
8	- - - - -	----	----
9	- - - - -	----	----
10	- - - - -	----	----

Sun Mon Tue Wed Thu Fri Sat

Start time : 00:00 Duration : 24:00

Recording Selector

Select *Camera 1* to *Camera 4* from the drop-down menu to configure the video stream from the corresponding camera head.

Recording Storage

Select **SD Card** or **Network Share** as recording storage.

Enable Recording Schedule

Two types of schedule mode are offered: **Always** and **Only during time frame**. You can select **Always** to activate recording on a storage medium or network storage all the time. Or, select a set

of schedule from the time frame blank, check specific weekdays and setup the start time (hour:minute) and time period (hour:minute) to activate the recording at certain time frames. The setting range for the duration time is from 00:00 to 168:59.

Click on **Save** to apply and store the settings.

To delete a schedule, select one from the schedule list, and click **Delete**.

Disable Recording Schedule

- Select **Disable** to terminate the recording function.
- Click on **Save** to apply and store the settings.

Schedule

To edit the schedule settings, select **System > Schedule**.

	Weekday	Start time	Duration
1	<input type="radio"/> - - - - - <input type="radio"/>	day	---
2	- <input type="radio"/> <input type="radio"/> - - - -	06:00	12:00
3	- - - - -	---	---
4	- - - - -	---	---
5	- - - - -	---	---
6	- - - - -	---	---
7	- - - - -	---	---
8	- - - - -	---	---
9	- - - - -	---	---
10	- - - - -	---	---

Sun Mon Tue Wed Thu Fri Sat

Day
 Night
 Time

Start time: Duration:

Schedules Setup

1. Select a time frame from the time frame list.
2. Check the weekday boxes below to choose the specific weekdays.
3. Select a time mode, Day, Night or Time. Under Time mode, specify the start time (hour:minute) and the time duration (hour:minute) to activate the schedule triggered features. The setting range for the time duration is from 00:00 to 168:59.

4. Click on **Save** to apply and store the settings.
Alternatively, click on **Delete** to remove the highlighted time frame.

Time Mode

- **Day**
The camera profile will be loaded when IR cut filter is on.
- **Night**
The camera profile will be loaded when IR cut filter is off.
- **Time**
This indicates the start time and the time duration for the schedule.

NOTE! Users MUST select **By schedule** under each feature setting page to enable the schedule function.

File Location (Snapshots and Web Recording)

To edit the file location settings, select **System > File Location**.

You can specify a storage location on the PC or in the hard drive for the snapshots and the live video recordings. The default setting is: C:\. Once the setting is confirmed, click on **Save**, and all the snapshots and the web recordings will be saved in the designate location.

NOTE! Make sure the selected file path contains valid characters such as letters and numbers.

View Information

To edit the view information settings, select **System > View Information**.

Click on **View Information**, there will be a drop-down menu with tabs including **Log File**, **User Information**, and **Parameters**.

Log File

To edit the log file settings, select **System > View Information > Log File**.

Click on the tab to view the system log file. The camera keeps a record of the system’s behavior and information related to the camera. These log data can be exported for future use. Click **generate syslog** and the Save File As dialog window will pop up. The default file name is named after the

model name and the MAC address as “Model Name-MAC-log.tgz”. Select the file destination and click **Save** to export the log data.

NOTE! “Save File As” dialog window may not show up immediately for the camera needs some time to process the log data.

User Information

To edit the user information settings, select **System > View Information > User Information**.

The administrator can view the privileges of each user (refer to [Security, p. 47](#)). User lines follow this syntax:

```
<User name>: <I/O access>:<camera control>:<talk>:<listen>
```

Example: <main-entrance>: 1:1:0:1

Values for <I/O access>, <camera control>, <talk>, and <listen>:

- 1: function allowed
- 0: function blocked

NOTE! The talk and listen privileges will be set regardless of the audio capabilities of the camera.

Parameters

To edit the parameters settings, select **System > View Information > Parameter**.

Click on this item to view the parameter settings of the entire system, such as Camera Settings, Mask Information and Network Information.

Factory Default

To edit the factory default settings, select **System > Factory Default**.

You can follow the instructions on this page to reset the camera to factory default settings if needed.

Full Restore

Click on **Full Restore** to recall the factory default settings. The camera system will restart in 30 seconds. The IP address will be restored to default. After the camera system is restarted, reconnect the camera using the default IP address. The default IP address is 192.168.0.250.

Partial Restore

Click on **Partial Restore** to recall the factory default settings (excluding network settings). The camera system will restart in 30 seconds. Refresh the browser page after the camera system is restarted.

NOTE! The IP address will not be restored to default.

Reboot

Click on **Reboot** and the camera system will restart without changing the current settings. Refresh the browser page after the camera system is restarted.

Software Version

To see the software version, select **System > Software Version**.

Software Upgrade

To edit the software upgrade settings, select **System > Software Upgrade**.

NOTE! Make sure the upgrade software file is available before carrying out software upgrade.

The procedure of software upgrade is as below.

1. Click on **Browse** and locate the upgrade file, for example, “ulmage_userland”.

NOTE! Do not change the name of the upgrade file, or the system will fail to find the file.

2. Pick a file type from the drop-down menu. In this case, select “ulmage+userland.img”.
3. Click on **Upgrade**. Then the system will prepare to start the software upgrade. Subsequently, an upgrade status bar will be displayed on the page to show the current upgrade process. After the upgrade process is finished, the viewer will return to the **Home** page.
4. Close the video browser.
5. Click on **Start** and activate the **Control Panel**. In the appeared window, double-click on **Add or Remove Programs**. A window with the **Currently install programs** list will pop up. In the list, select the viewer and click on **Remove** to uninstall the existing program.
6. Open a new web browser and re-login the camera. Users will be prompted to download the viewer. Once the viewer is downloaded and installed, the live video will be available.

Maintenance

To edit the maintenance settings, select **System > Maintenance**.

You can export configuration files to a specified location and retrieve data by uploading the configuration file to the camera.

Export Files

You can save the system settings by exporting a configuration file (.bin) to a specified location for future use. Click on **Export**, and the popup File Download window will come out. Click on **Save** and specify a desired location for saving the configuration file.

Upload Files

To upload a configuration file to the camera, click on **Browse** to select the configuration file and then click on **Upload** for uploading.

The “Streaming” Tab

To edit the video configuration settings, select **Streaming > Video Configuration**.

The screenshot displays the MOBOTIXMOVE interface for video configuration. At the top, there is a navigation bar with 'Home', 'System', 'Streaming' (highlighted), 'Camera', and 'Logout'. A language dropdown is set to 'English'. On the left, a blue sidebar lists menu items: 'Video Configuration' (selected), 'Video Rotation', 'Video Text Overlay', 'Video ROI', 'Video ROI Encoding', 'Video OCX Protocol', 'Video Mask', and 'Audio'. The main content area is titled 'Video Configuration' and contains two sections for 'stream 1' and 'stream 2'. Each stream section includes dropdown menus for 'Encoding' (Yes), 'Encode Type' (H.264), 'Resolution' (1920 x 1080), and 'Rate Control' (VBR). Stream 1 also includes a 'Profile' dropdown (Main profile), a 'Framerate' slider (30), a 'Bitrate' slider (4096), and a 'GOV Length' slider (60). Stream 2 has identical settings. At the bottom right, there are 'Save' and 'Reset' buttons.

NOTE!

- Only the administrator can access the **Streaming** configuration page.
- The preset resolution and other settings will vary depending on the current camera model.

Video Configuration

To edit the video configuration, select **Streaming > Video Configuration**.

Encoding

For **stream 2** to **stream 4**, select **Yes** to enable a stream and **No** to disable it.

Encode Type

The available video resolution formats include H.265, H.264, and MJPEG. You can select the preferred encode type from the drop-down menu.

Resolution

The following table lists the default resolution of the camera.

IP Camera Model		Default Resolution
2MP Vandal Bullet ALPR Camera	WDR on/off	H.265/H.264: 1920 × 1080 (30 fps) +
Mx-VB1A-2-IR(-D)-ALPR		MJPEG: 1080p (30 fps)

Frame Rate

Video frame rate is for setting the frames per second (fps) if necessary.

The default setting of Stream 1 is 30 fps (NTSC) or 25 fps (PAL). The maximum frame rate range of each stream will change according to the selected video resolution.

NOTE!

- Low frame rate will decrease video smoothness.
- Please make sure the higher compression ratio is supported by the system before setup.

Profile

You can set H.265/H.264 Profile to **High Profile** or **Main Profile** according to its compression needs. With the same bit rate, the higher the compression ratio, the better the image quality is. The default setting is **Main Profile**.

Rate Control

The following H.265/H.264 bit rate modes are supported:

- **CBR (Constant Bit Rate)**

The video bitrate of the video stream will be fixed and consistent to maintain the bandwidth.

- **VBR (Variable Bit Rate)**

The video bitrate of the video stream varies according to the activity of the monitoring environment to achieve better image quality.

Click on **Save** to apply and store the settings.

Bit Rate

The default setting of the H.265/H.264 bit rate for Stream 1/2 is 4096 kbit/s; for Stream 3/4 is 2048 kbit/s. The setting range is from 64 to 20480 kbit/s, and the total bit rate should not exceed 51200 kbit/s.

GOV Length

You can set the GOV length to determine the frame structure (I-frames and P-frames) in a video stream to save bandwidth. Less bandwidth is needed if the GOV length is set to a high value. However, the shorter the GOV length, the better the video quality is.

The default setting for the available streams is 50. The setting range of the GOV length is from 1 to 4094.

Q (Quality) Factor (MJPEG Only)

The default setting of MJPEG Q factor is 35; the setting range is from 1 to 70.

BNC Support

The **BNC Support: (Yes/No)** item indicates whether the current resolution combination supports BNC output.

If users want to check the camera view via connecting a BNC monitor, please configure the stream/resolution settings as below:

Stream	Resolution
Single Stream	All available resolutions of Stream 1
Dual Stream	(1) Stream 1 = Stream 2 or (2) Stream 2 \leq D1
Triple Stream	Stream 1 = Stream 2 = Stream 3
Quad Stream	Stream 1 = Stream 2 = Stream 3 = Stream 4

Source

You can set the viewing mode of specific camera models here. The resolution options will vary according to the viewing mode selected from the **Source** drop-down list.

The default setting for Stream 1 is “overview” Mode.

The screenshot shows the 'Video Configuration' window for 'stream 1'. It contains two columns of settings. The left column includes: Encoding (Yes), Encode Type (H.264), Resolution (2048 x 2048), and Rate Control (VBR). The right column includes: Source (overview, highlighted with a red box), Profile (Main profile), Framerate (15), Bitrate (4096), and GOV Length (50). Each setting is either a dropdown menu or a slider with a numeric input field.

Click on **Save** to confirm the setting or click on **Reset** to return to the previous settings.

Video Rotation

Rotate Function

You can change video display type if necessary. Selectable video rotate types include Mirror video and 90/180/270 degree clockwise rotate. Refer to the following descriptions for the different video rotate type.

- **Mirror**

Select **yes** from the drop-down menu, and the image will be mirrored horizontally.

- **Rotate Type**

You can choose 0, 90, 180, or 270 degrees from the drop-down menu to rotate the image.

Click on **Save** to apply and store the settings.

Video Text Overlay

You can select the items to display data including date & time/text string/subtitle/image on the live video pane.

Overlay Type

You can select at most three items out of four options including date & time/text string/subtitle/image to display on the live video pane.

■ **Include Date & Time**

Check the box to enable date & time display on the Live Video Pane and a Video Text Overlay Window will show up. Move the mouse cursor to the center of the window then click and drag the window to preferred display position. You can choose to display date, time, or date & time from the drop-down menu, and decide the string align position (left/right).

■ **Include Text String**

Check the box to enable text string display on the Live Video Pane and a Video Text Overlay Window will show up. Move the mouse cursor to the center of the window then click and drag the window to preferred display position. Type the text to display in the entry field and decide the string align position (left/right). The maximum length of the text string is 15 alphanumeric characters.

■ **Include Subtitle**

Check the box to enable subtitle display on the Live Video Pane and a Video Text Overlay Window will show up. Move the mouse cursor to the center of the window then click and drag the window to preferred display position. Type the text to display in the entry field and decide the string align position (left/right). You can set at most 5 subtitles, and the maximum length of each subtitle is 16 alphanumeric characters.

■ **Include Image**

Check the box to enable image display on the Live Video Pane and a Video Text Overlay Window will show up. Move the mouse cursor to the center of the window, click and drag the window to preferred display position, and then decide the string align position (left/right).

Click on **Set** to confirm the setting.

Text Overlay Setting

You can choose the Text Overlay Color (black, white, yellow, red, green, blue, cyan, or magenta) and Text Overlay Size (small, medium, or large) of the display date & time/text string/subtitle.

Click on **Set** to confirm the setting.

Image Overlay Setting

Users must save the image as a 8-bit BMP file; the length should be the multiple of 32, and the width should be the multiple of 4. The maximum resolution of the image should not exceed 32768 pixels.

Click on **Set** and **Upload** to confirm the setting.

Video ROI

To edit the video ROI settings, select **Streaming > Video ROI**.

ROI stands for Region of Interest. This function allows users to select specific monitoring region for Stream 1~Stream 4, instead of showing the full image.

NOTE! To use ROI function, dual streaming or above must be enabled and the resolution of each streaming must be different.

NOTE! Video ROI function is not available when Digital Zoom is open.

Enable Stream 1 ~ Stream 3 ROI Setting

Only the stream with the second highest resolution among the enabled streams is available for Video ROI Setting.

Check the box on the specific stream to display the ROI Window. Note that Video ROI Setting is NOT available when only 1 stream or all 3 streams are enabled, or when at least two of the streams are set to the same resolution. To adjust the ROI Window, click and drag the edge of the window outward/inward. To shift the window to the intended location, click the center of the ROI Window and drag the mouse cursor.

Click **Save** to apply the setting.

Enable Stream 1 ~ Stream 4 ROI Setting

Check the boxes and Stream 1~ Stream 4 ROI Window will be displayed. Note that video ROI is NOT available for the streaming set as the highest resolution among the enabled streaming. To adjust the ROI Window, click and drag the edge of the window outward/inward. To shift the window to the intended location, click the center of the ROI Window and drag the mouse cursor.

Click **Save** to apply the setting.

Video ROI Encoding

To edit the video ROI encoding settings, select **Streaming > Video ROI Encoding**.

Video ROI Encoding is to set the compression of the selected zone within ROI for better performances; at most three zones can be set in the interested region. However, this function does NOT support MJPEG video format.

The following shows how to setup Video ROI Encoding. To implement this function, Video ROI must be setup beforehand.

- Select a video stream from **Video Stream**.
- Select **Enable** from **ROI Encoding** to implement ROI Encoding.
- Click on **Add**, click and drag the center of the window to move it to the interested location; click and drag the edge of the window outward/inward to resize the window.

NOTE! The total size of the three windows CANNOT be larger than the half size of the ROI. When exceeds, a warning window will pop up.

- Choose the quality of the setting zone from **Quality**.
The higher the value, the better the image quality (higher bit rate) of the setting zone will be. On the contrary, the lower the value, the lower the image quality (lower bit rate) of the selected area will be.
- Click on **Save** to apply and store the settings.

Video OCX Protocol

To edit the video OCX protocol settings, select **Streaming > Video OCX Protocol**.

In the **Video OCX protocol** setting page, the administrator can select RTP over UDP, RTP over RTSP (TCP), RTSP over HTTP or MJPEG over HTTP, for streaming media over the network. In the case of multicast networking, you can select the Multicast mode. Click on **Save** to confirm the setting.

Video OCX protocol setting options include:

- **RTP over UDP/RTP over RTSP(TCP) / RTSP over HTTP/MJPEG over HTTP**
- **Multicast Mode**
Enter all required data, including **Multicast Stream 1~4 Video Address/Multicast Stream Audio Address, Multicast Port** and **Multicast TTL** into each blank.

Click on **Save** to apply and store the settings.

Video Mask

To edit the video mask settings, select **Streaming > Video Mask**.

Active Mask Function

- **Add a Mask**

Check a Video Mask checkbox, and a red frame will come out in the Live Video pane. Use the mouse to drag and drop to adjust the mask’s size and place it on the target zone. At most 5 video masks can be set.

NOTE! It is suggested to set the Video Mask slightly bigger than the object.

- **Cancel a Mask**

Un-check the Video Mask checkbox meant to be deleted; the mask will disappear from the Live Video pane instantly.

Mask Setting

- **Mask color**

The selections of Mask color include black, white, yellow, red, green, blue, cyan, and magenta. Click on **Save** to apply and store the settings.

Audio (Audio Mode and Bit Rate Settings)

To edit the audio mode settings, select **Streaming > Audio**.

In this page, the administrator can adjust the sound transmission mode, the audio gain levels and the audio bit rate. Setting for enabling sound recording to the microSD/SD card is also available.

Transmission Mode

- **Full-duplex (Talk and Listen simultaneously)**

In the Full-duplex mode, the local and remote sites can communicate with each other simultaneously, i.e. both sites can speak and listen to the other side at the same time.

- **Half-duplex (Talk or Listen, not at the same time)**

In the Half-duplex mode, the local/remote site can only talk or listen to the other site at a time.

- **Simplex (Talk only)**

In the Talk only Simplex mode, the local/remote site can only talk to the other site.

- **Simplex (Listen only)**

In the Listen only Simplex mode, the local/remote site can only listen to the other site.

- **Disable**

Select the item to turn off the audio transmission function.

Server Gain Setting

Set the audio input/output gain levels for the sound amplification. The audio input gain value is adjustable from 1 to 10. The audio output gain value is adjustable from 1 to 6. The sound will be turned off if the audio gain is set to “Mute”.

Bit Rate

Selectable audio transmission bit rate include 16 kbit/s, 24 kbit/s, 32 kbit/s, 40 kbit/s, uLAW (64 kbit/s), ALAW (64 kbit/s), AAC (128 kbit/s), PCM (128 kbit/s), PCM (256 kbit/s), PCM (384 kbit/s), and PCM (768 kbit/s). Higher bit rate will let higher audio quality and require bigger bandwidth.

Click on **Save** to apply and store the settings.

Input Type

Click on **Save** to apply and store the settings.

Recording to Storage

Select **Enable** from the drop-down menu to enable audio recording with videos into the microSD/SD card or the NAS.

NOTE! If the chosen bit rate is not compatible with the player, there will only be noise instead of audio during playback.

Click on **Save** to apply and store the settings.

The “Camera” Tab

The screenshot shows the MOBOTIXMOVE web interface. At the top, there is a navigation bar with 'Home', 'System', 'Streaming', 'Camera' (selected), and 'Logout'. A language dropdown is set to 'English'. Below the navigation bar, a left sidebar contains a list of camera settings: Exposure, White Balance, Picture Adjustment, Color Style, IR Function, Noise Reduction, WDR Function, Digital Zoom, Backlight, Profile, and TV System. The 'Exposure' setting is currently set to 'WDR 2 shutter'. The main area displays a live video stream of a train station with several high-speed trains. Below the video stream, there are control buttons for ZOOM (WIDE, TELE), FOCUS (NEAR, FAR), and AF Mode (MANUAL, ZM TRIG, PUSH AF). There are also 'RESET' buttons and a '1 step' dropdown menu for zoom and focus. On the right side of the control panel, there are icons for microphone, speaker, camera, and a red stop button.

Exposure

To edit the exposure settings, select **Camera > Exposure**.

Exposure is the amount of light received by the image sensor. It is determined by the width of lens diaphragm opening, the shutter speed and other exposure parameters. With these items, you can define how the Auto Exposure function works. You can select one of the exposure modes according to the operating environment. Each exposure mode is specified as follows.

NOTE! The available settings and the shutter speed range will vary depending on the lens/CMOS sensor combination.

Auto Mode

■ Window Setting

With this function, you can determine which area of the camera scene is used to calculate the exposure. Follow the steps below to set the Auto Exposure (AE) window.

- Point the camera to the monitoring area.
- Select **On** to enable the function.
- Click and drag the center of the AE window to move it to the interested location; click and drag the edge of the window outward / inward to resize the window.
- Click on and the camera will automatically adjust the exposure parameters according to the light condition of the user defined area.

NOTE! AE Window Setting function is **NOT** available when TV system is set as **WDR 2 Shutter**.

■ Max Gain

Maximum Gain can be set to reduce image noises. The Max Gain ranges from 3 dB to 48 dB, or select **Off** to disable the function. The default setting is 48 dB.

■ Auto Iris



In this mode, the camera will automatically adjust the iris to suit the environment illumination. The minimum shutter speed can be set from 1/30 to 1 sec. (NTSC) or 1/25 to 1/3 sec. (PAL). AGC (Auto Gain Control) will function automatically according to the light conditions of the subject.

■ P-Iris Priority Mode

P-iris priority mode is only available for Zoom Lens and Motorized Lens models. In addition, applied with different lens, the related setting options also vary. Refer to the following for further details.



■ Zoom Lens

Select **Auto Detect** and the camera will automatically detect the best iris size for the environment. Alternatively, you can manually adjust the iris size by selecting **Manual**.

Click  and  to adjust the iris size. The minimum shutter speed can be set from 1/30 to 1 sec. (NTSC) or 1/25 to 1/1.5 sec. (PAL).

■ Motorized Lens

Click on , and the camera will automatically detect the best iris size for the environment. If necessary, you can select and manually to adjust the iris size. Alternatively,

click on  to reset the iris size, and the iris size will be set to the largest. Then, you can manually adjust the iris size by selecting  and . The minimum shutter speed can be set from 1/500 to 1/2 sec. (NTSC) or 1/425 to 1/3 sec. (PAL).

■ Iris Priority Mode

In this mode, it is the iris that has premier priority in control of the exposure. The range of the iris size is from 0 to 9, or select **Full open** to fully open the iris. The minimum shutter speed can be set from 1/30 to 1 sec. (NTSC) or 1/25 to 1/1.5 sec. (PAL).

■ Auto Shutter Mode

In this mode, the camera will automatically adjust the shutter speed and the iris size according to the light intensity. It is also effective if a fixed iris lens is being used. The minimum shutter speed range is configurable from 1/500 to 1/2 sec. (NTSC) or 1/425 to 1/3 sec. (PAL).

■ Shutter Priority Mode







In this mode, it is the shutter speed that takes the main control of the exposure. The range is configurable from 1/500 to 1/30 sec. (NTSC) or 1/425 or 1/25 sec. (PAL).

Manual Mode

With this mode, you can select the suitable shutter speed, iris size and gain value according to the environmental illumination. The shutter speed ranges from 1/10000 to 1 sec. (NTSC) or from 1/10000 to 1/1.5 sec. (PAL).

The range of the iris size is from 0 to 9, or select **Full open** to fully open the iris. The gain value range is from 3 dB to 48 dB, or select **Off** to disable the function.

NOTE! The **Iris Size** setting is only available for models with Zoom Lens.

NOTE! For Motorized Lens models, the iris size setting differs. To set the iris size, click on , and the camera will auto detect the best iris size for the environment. If necessary, users still can manually adjust the iris size by selecting  and . Alternatively, click on  to reset the iris size. The iris size will be set to the largest. Then, you can manually adjust the iris size by selecting  and .

White Balance

To edit the white balance settings, select **Camera > White Balance**.

A camera needs to find reference color temperature, which is a way of measuring the quality of a light source, for calculating all the other colors. The unit for measuring this ratio is in degree Kelvin (K). You can select one of the White Balance Control modes according to the operating environment. The following table shows the color temperature of some light sources for reference.

Light Sources	Color Temperature in K
Cloudy Sky	6,000 to 8,000
Noon Sun and Clear Sky	6,500
Household Lighting	2,500 to 3,000
75-watt Bulb	2,820
Candle Flame	1,200 to 1,500

Auto Mode

The Auto White Balance mode is suitable for environments with light source having color temperature in the range roughly from 2700K to 7800K.

ATW Mode (Auto Tracking White Balance)

With Auto Tracking White Balance function, the white balance in a scene will be automatically adjusted while temperature color is changing. The AWB.wide mode is suitable for environments with light source having color temperature in the range roughly from 2500K to 10000K.

AWB.normal

The AWB (Auto White Balance).normal mode is suitable for environments with light source having color temperature in the range roughly from 2700K to 7800K.

AWB.wide

With AWB (Auto White Balance).wide function, the white balance in a scene will be automatically adjusted while temperature color is changing. The AWB.wide mode is suitable for environments with light source having color temperature in the range roughly from 2500K to 10000K.

AWB.all

The AWB (Auto White Balance).all mode is suitable for environments with light source having color temperature under 2500K or over 10000K.

Smart Mode

The Smart mode is suitable for environments with one single background color which is strongly saturated, for instance, in a forest.

One Push

With One Push function, white balance is adjusted and fixed according to the scene the camera currently sees. This function is best for situations with minimal scene changes and continuous lighting. The function is suitable for light sources with any kind of color temperature. Follow the steps below to set the white balance.

- Point the camera to the monitoring area.
- Select **One Push** in the White Balance setting menu
- Click the  button to adjust the color tone of the live images.

NOTE! In this mode, the value of white balance will not change as the scene or the light source varies. Therefore, users might have to re-adjust the white balance by clicking the  button again when needed.

Smart Touch Mode

With Smart Touch function, you can select an area in the camera scene as the reference point for white balance. Please ensure that the background color of the selected area is white. Smart Touch function is suitable for environments with unchanged brightness level.

Manual Mode

In this mode, you can manually adjust the White Balance value. Input a number between 0 to 249 for “Rgain/Bgain” to adjust the red/blue illuminant on the Live Video Pane. The following describes several situations that might occur during the White Balance manual adjustment.

- The video image turns reddish (as the left picture below).

The higher the Rgain value, the redder the image will be. To solve the problem, reduce the Rgain value, and the video image will turn less reddish.



Reddish Image



Corrected White Balance

- The video image turns greenish (as the left picture below).

The lower the Rgain value, the greener the image will be. To solve the problem, Increase the Rgain value, and the video image will turn less greenish.



Greenish Image



Corrected White Balance

- The video image turns bluish (as the left picture below).

The higher the Bgain value, the bluer the image will be. To solve the problem, reduce the Bgain value, and the video image will turn less bluish.



Bluish Image



Corrected White Balance

Menu Reference

The “Camera” Tab

- The video image turns yellowish (as the left picture below).
The lower the Bgain value, the yellower the image will be. To solve the problem, Increase the Bgain value, and the video image will turn less yellowish.



The following image displays the general color shifts of the scene when different Rgain/Bgain combinations are applied.



Picture Adjustment

To edit the picture adjustment settings, select **Camera > Picture Adjustment**.

- **Brightness**
The brightness level of the images is adjustable from -12 to +13. The default value is 0.

- **Sharpness**

The sharpness level of the images is adjustable from +0 to +15. The edge of the objects is enhanced as the sharpness level increases. The default value is +4.

- **Contrast**

The contrast level of the images is adjustable from -6 to +19. The default value is 0.

- **Saturation**

The saturation level of the images is adjustable from -6 to +19. The default value is 0.

- **Hue**

The hue level of the images is adjustable from -12 to +13. The default value is 0.

Color Style

To edit the color style settings, select **Camera >Color Style**.

Color style can automatically adjust the brightness, allowing users to select the best color style mode based on the operating environment.

- **Normal**

The default setting is normal mode.

- **Dark Detail Brighter**

This mode increases brightness on dark areas of the image.

- **Highlight Detail Brighter**

This mode increases brightness on general-illuminated areas of the image.

IR Function

To edit the IR function settings, select **Camera > IR Function**.

Day/Night Function

This item is for users to define the action of the IR cut filter and IR LED lights. Refer to the descriptions of each option below to select a suitable mode.

- **Auto**

With this mode, the camera will decide when to remove the IR cut filter. Please refer to [Day/Night Threshold, p. 102](#) for further details.

- **Night**

Use this mode when the environment light level is low. The IR cut filter will be removed to allow the camera to deliver clear images in black and white.

- **Day**

Select this mode to turn on the IR cut filter. The IR cut filter can filter out the IR light and allows the camera to deliver high quality images in color.

- **Light Sensor(Default)**

In this mode, for cameras with built-in IR LED modules, the light sensor will decide the occasion to turn the IR LED lights on/off. For cameras with non-IR modules, the light sensor will decide the occasion to take the IR cut filter on/off.

- **Light On (Built-in IR LED Modules Only)**

In this mode, IR LED lights will always be on.

- **Light Off (Built-in IR LED Modules Only)**

In this mode, IR LED lights will always be off.

- **Smart**

With Smart mode, the camera will decide the occasion to remove the IR cut filter. The Smart mode mechanism can judge whether the main light source is from IR illumination. If so, the IR cut filter will be kept removed (i.e. monochrome/night mode).

NOTE! It is recommended to select “Smart Mode” when the camera sets high zoom ratio for close-up view.

Day/Night Threshold

This item is for users to set when the camera should switch from day mode to night mode or vice versa. The camera will sense the surrounding brightness, and the threshold value stands for the level of the light. Once the camera detects the light level reaches the set threshold, the camera will automatically switch to Day/Night Mode. The range of the level is from 0 to 10, (darker = 0; brighter = 10).

- **Night Mode to Day Mode** 

The lower the value, the earlier the camera switches to Day mode. The default value is 7.

- **Day Mode to Night Mode** 

The higher the value, the earlier the camera switches to Night mode. The default value is 3.

NOTE! Equipped with different CMOS sensors, the time the camera switches to Day/Night mode may also vary from models to models even if the threshold is set to the same value.

IR Light Compensation

With the IR Light Compensation function, the camera can prevent the center object close to the camera from being too bright when IR LED lights are turned on.

NOTE! IR Light Compensation function is **NOT** available when **Auto Exposure Window Setting** function is enabled.

IR Heating

IR heating function is provided for cameras installed under icy and humid environment. Activate the function to avoid ice accumulating on the surface.

Noise Reduction

To edit the noise reduction settings, select **Camera > Noise Reduction**.

The camera provides multiple **Noise Reduction** options for delivering optimized image quality especially in extra low-light conditions.

3DNR

3DNR (3D Noise Reduction) function delivers optimized image quality especially in extra low-light conditions.

Different levels of 3DNR are provided, including 3DNR Low, 3DNR Mid and 3DNR High. Higher level of 3DNR generates relatively enhanced noise reduction.

2DNR

2DNR (2D Noise Reduction) function delivers clear images without motion blurs in extra low-light conditions.

Select **on** to turn on 2DNR function; otherwise, select **off** to turn off 2DNR function.

ColorNR

In a dark or insufficient light environment and the camera is under color mode, ColorNR (Color Noise Reduction) can eliminate color noise.

Three levels of ColorNR, including Color Low, Color Mid and Color High, are provided. The higher level of ColorNR generates relatively enhanced noise reduction.

WDR Function

To edit the WDR settings, select **Camera > WDR Function**.

The Wide Dynamic Range (WDR) function is for solving high contrast or changing light issues to enhance video display quality. Different level options for WDR include Low, Mid and Hi. Higher level of WDR represents wider dynamic range, so that the camera can catch a greater scale of brightness.

Digital Zoom

To edit the digital zoom settings, select **Camera > Digital Zoom**.

Select **On** to enable digital zoom, select **Off** to disable the function.

Backlight

To edit the backlight settings, select **Camera > Backlight**. This function will be available when the video format in [TV System, p. 105](#) has been set to “60fps” or “50fps”.

NOTE! Backlight function is **not** available when [TV System, p. 105](#) has been set to *WDR 2 Shutter*.

Backlight compensation prevents the center object from being too dark in surroundings where excessive light is behind the center object. Select **on** to turn on the function; otherwise, select **off** to turn off the function.

Defog



Click on **Camera > Defog** and select *On* to improve the camera images in foggy conditions. In this mode, the camera applies contrast enhancement to improve the colors in the images.

Profile

To edit the camera profile settings, select **Camera > Profile**.

Camera Profile allows users to setup the desired image parameters for specific environments with different time schedules. You can setup at most 10 sets of camera parameter configuration under the Camera tab. To enable this function, users must setup the schedules in advance. Refer to section [Schedule](#) for further details of schedule setup. Then, follow the steps below to setup a camera profile.

Camera Profile Setup

1. In the “Camera” tab, setup the camera parameters, such as White Balance, Picture Adjustment, etc., excluding TV System.
2. Click on Profile and its setting menu will be displayed. Select a number from the Num drop-down menu.
3. Input a name for the profile in the Name field.
4. Click on  below the Name field. The camera configuration is saved and applied to the profile. Now a camera profile is created and saved.
5. Select a profile from the Num drop-down menu.
6. Tick the By schedule box. Check the desired schedule(s) from the Schedule drop-down menu. Multiple schedules can be applied to one profile.
7. Click on  below **By schedule**.
8. Follow the steps above to set the rest of the profiles.

Now, the camera will automatically switch profiles according to the schedule. Alternatively, manually select a number from the Num drop-down menu. Then, click on , the camera will load and apply the setting of the profile.

NOTE! If users wish to set the camera parameters to factory default setting, select **Normal** from the Num drop-down menu. The camera will start loading the default values.

NOTE! Users MUST set the camera parameter of the last profile as the default setting. Thus, if there are gaps among schedules, the camera will apply the setting of the last profile.

TV System

To edit the TV system settings, select **Camera > TV System**.

Select the video format that matches the present TV system from the drop-down menu. The following table shows the available video formats for different types of models. The supported video formats for each model are marked by “✓”.

Video Format	2MP Vandal Bullet ALPR Camera
NTSC 30 fps	✓
WDR 2 Shutter	✓

Menu Reference

The "Camera" Tab

Video Format		2MP Vandal Bullet ALPR Camera
PAL	25 fps	✓
	WDR 2 Shutter	✓

The “Logout” Tab

Click on the tab **Logout** on the top of the page, and the login window will pop up. This enables logging in with a different username.

Appendix A: Installing UPnP Components

Please follow the instructions below to install UPnP components on Windows computers.

1. In Windows, go to **Start**, click on **Control Panel**, and then double-click on **Add or Remove Programs**.
2. Click on **Add/Remove Windows Components** in the **Add or Remove Programs** page.
3. Select **Networking Services** from the Components list in Components Wizard window of the Windows, and then click **Details**.
4. Select **UPnP User Interface** in the Networking Services' subcomponents list and then click on **OK**.
5. Click on **Next** in the Windows Components Wizard window.
6. Click on **Finish** to complete installation.

Appendix B: Converting IP Addresses from Decimal to Binary

Follow the example below to convert the IP addresses to binary numbers. Use the calculator on the computer for conversion: **Start > All Programs > Accessories > Calculator**.

- Windows 7/8: Click **View** on the calculator and click **Programmer**.
- Windows 10/11: Click on the menu button  and select **Programmer**.

The example below shows how to convert 192.168.2.81 to binary numbers.

1. On the left of the calculator, select **Dec**. Then enter the first decimal number of the IP address, “192”. Select **Bin** and the number will be converted to binary number. Repeat the same procedure with the rest of decimal numbers. Remember to select **Dec** before entering the next decimal number. Otherwise a decimal number cannot be entered. The table below shows the binary representation of each decimal number.

Decimal Numbers Binary Numbers

192	11000000
-----	----------

168	10101000
-----	----------

2	10
---	----

81	1010001
----	---------

2. Each binary number should have eight digits. If a binary number does not have eight digits, please add leading zeros until it does. The binary number of each decimal number should be as follows.

Decimal Numbers Binary Numbers

192	11000000
-----	----------

168	10101000
-----	----------

2	00000010
---	-----------------

81	01010001
----	-----------------

Therefore, the binary representation of IP address 192.168.2.81 is

11000000.10101000.00000010.01010001.

Appendix C: List of Open/Closed IP Ports

The following tables list the ports for the TCP and UDP IP protocols on the MOBOTIX MOVE cameras.

TCP Protocol

Port number	Service	Default
Port number	Service	Default
80	HTTP	open
443	HTTPS	open
554	RTSP	open
5555	UPnP	open

UDP Protocol

Port number	Service	Default
68	DHCP	open
161	SNMP	closed
1900	UPnP	open
3702	ONVIF Probe	open
5353	Bonjour	open
6666	Device Search (Dynacolor search tool)	open
15070	audio talk (RTP from PC to IPCam)	closed
15071	audio talk (RTCP)	closed
18890	stream1 video multicast RTP port	open
18891	stream1 video multicast RTCP port	open
18900	stream2 video multicast RTP port	open
18901	stream2 video multicast RTCP port	open
18910	stream3 video multicast RTP port	open

Port number	Service	Default
18911	stream3 video multicast RTCP port	open
18920	stream4 video multicast RTP port	open
18921	stream4 video multicast RTCP port	open
18930	audio multicast RTP port	open
18931	audio multicast RTCP port	open
18940	meta-data multicast RTP port	open
18941	meta-data multicast RTCP port	open
19800	MxMessage system	open

ALPR Best Practices

This section contains the following information:

Introduction	114
Camera Setup and Configuration for License Plate Recognition ..	115
Licensing ALPR	127
Configuring ALPR	138
Updating the ALPR System Software	198
Troubleshooting	199
Variables for Dynamic Text Replacement	202
Note on Timestamp Formats	206

Introduction

This section has been designed to guide you through the process of for setting up and configuring the MOBOTIX MOVE camera and the ALPR software.

The ALPR software is a real-time solution for Automatic License Plate Recognition (ALPR) that runs entirely within the MOBOTIX MOVE camera. The software includes MMC (Make, Model and Color Recognition) with Vehicle Classification.

Best Practices in positioning and setting up the MOBOTIX MOVE camera

ALPR (Automatic License Plate Recognition) is an image processing technology used to identify vehicles by their license plates. It is also known as ANPR (Automatic Number Plate Recognition) amongst other names.

A good clear image captured at the optimum angle is essential to achieve a good license plate recognition rate.

Camera Setup and Configuration for License Plate Recognition

In this section, we describe how to set up the MOBOTIX MOVE Camera for optimum image quality. An intelligent ALPR camera is a specialized CCTV camera that has in-built software to identify license plates on still or moving vehicles. The ALPR software has been optimized to run on the MOBOTIX MOVE camera taking advantage of the high-speed processor and direct data transfer from the image sensor.

Setting up the MOBOTIX MOVE Camera

Once the MOBOTIX MOVE camera has been installed it must be set up and configured. Use a web browser to log on to the camera using its IP address.

NOTE! Refer to the MOBOTIX MOVE documentation for the default IP address. The default user-name and password are normally admin/meinsm.

Set the date and time of the camera

To set the date and time within the MOBOTIX MOVE camera, select the **System** Tab:

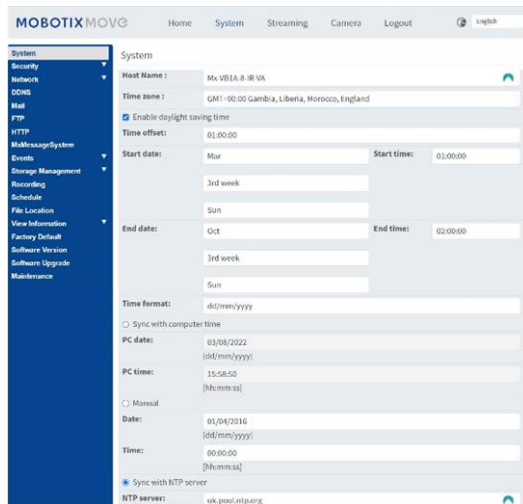

Here we can set the time zone and synchronize the time with a time server and in this example, we are using one of the UK NTP Servers.

Setting a DNS Server

When the software is first run, it will attempt to connect to the internet to check for the latest version of the software. To allow this to happen you should configure a DNS server (Domain Name Server). (Note this is also often needed for BOF connections to map your domain names).

To do this go to the main MOBOTIX MOVE System Tab menu and select Network and then Basic:

Select a DNS server such as Google's as follows:

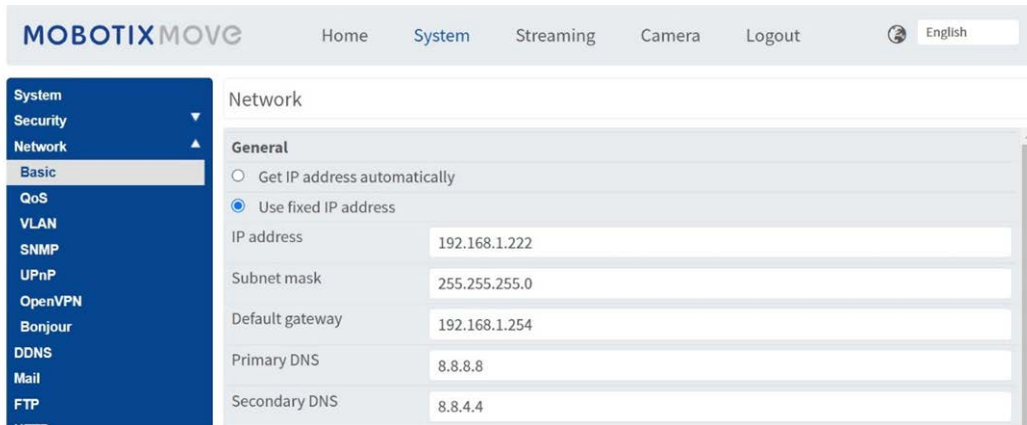

In this case Google's is 8 . 8 . 8 . 8 with a secondary server of 8 . 8 . 4 . 4. These are free Google DNS servers which will map any domain names needed to the correct IP address.

Zoom (Focal Length) and Focus

Under the Camera tab you can change camera's field of view (FOV) using the ZOOM buttons to the portion of road that you require. Concentrate the FOV on the road only and do not waste resolution on grass verges, pavements etc. Sometimes this results in not enough resolution being available for accurate results in the main part of the image, and it can also slow down recognition times.

In this example about 2m on the left of the image is not being used for recognition:



The focal length of the lens determines how **zoomed in** the image is. It is usually expressed in millimeters (e.g., 6 mm, 25 mm, or 50 mm). The focal length tells us the angle of view (how much of the scene will be captured) and the magnification (how large individual elements will be). The longer the focal length, the narrower the angle of view and the higher the magnification. The shorter the focal length, the wider the angle of view and the lower the magnification.

In the case of zoom lenses, both the minimum and maximum focal lengths are stated, for example 3.6–22mm.

MOBOTIX MOVE cameras come with zoom or motorized lenses. As a rough guide, the following cameras will operate at the specified ranges:

Single lane (3m wide):

MOVE 4K (3.6-11mm lens) @1920 max HFOV 3m: 2-12.5m Range Day/Night

MOVE 2K (3.6-11mm motorized lens) @1920 max HFOV 3m: 2.5-16m Range Day/Night

MOVE 2K (9-22mm zoom lens) @1920 max HFOV 3m: 5.5-33m Range Day, Night 25m est.

Dual/Wide lane (6m wide):

MOVE 4K (3.6-11mm lens) @1920 max HFOV 6m: 4-12m Range Day/Night

MOVE 2K (3.6-11mm motorized lens) @1920 max HFOV 6m: 4.5-16m Range Day/Night

MOVE 2K (9-22mm zoom lens) @1920 max HFOV 6m: 10.5-33m Range Day, Night 25m est.

Stream Settings: Resolution

The resolution of the camera determines the amount of detail that can be captured. The smaller the object detail, the higher the resolution that is required. If you are only running the MOBOTIX MOVE ALPR App then there is no need to set the resolution in the main camera settings – you can specify this later with the App Settings. However, you should set ONE of the streams to have an Encode Type of MJPEG to ensure that live video can be viewed when setting up the App.

Stream Settings: Frame Rate

NOTE! Does not need to be set for ALPR

The frame rate is the number of frames or images that the camera can capture per second. For example, 30 fps means the camera captures 30 frames in a single second of video.

If you are only running the MOBOTIX MOVE ALPR App then there is no need to set the frame rate. The App will set this internally.

Setting the shutter speed and other important image settings

The camera's image and shutter settings should have been factory set for ALPR. If you need to change or restore these then click on the Camera Tab.

The following options are displayed:

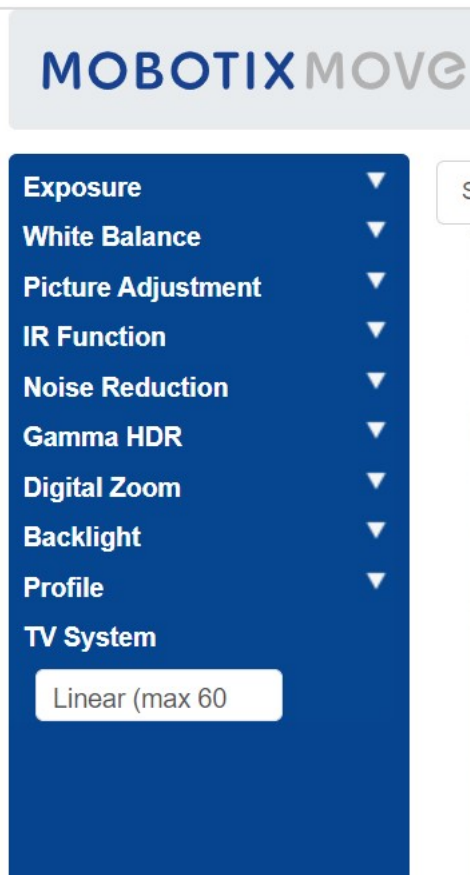

We will now examine these options in detail:

Exposure

Window Setting

Turn on and then use the cursor to set a (red) window to be used for changing the image brightness. Useful if you have a wide-angle view and are picking up bright objects from the edge of the image which affects the exposure of vehicles.

AE Priority

Aperture priority allows you to set the shutter speed (which needs to be fast) over image quality. Real-time ensures that the shutter speed takes priority over the iris settings

Night Mode Priority

- Normal: This may lighten darker images
- Highlight detail: Decreases overall brightness to make bright targets more visible

Max Gain

30db will lighten night time images – but the higher the gain, the more noisier the images will be in low light conditions. This is a compromise.

Auto Shutter

- Set the shutter speed to 1/500th sec for slow to medium speed traffic.
- Set this higher if the traffic is fast to avoid motion blur. 1/1000th sec should be good up to 150kph with a shallow angle of view and for very high speeds use 1/2000th sec.

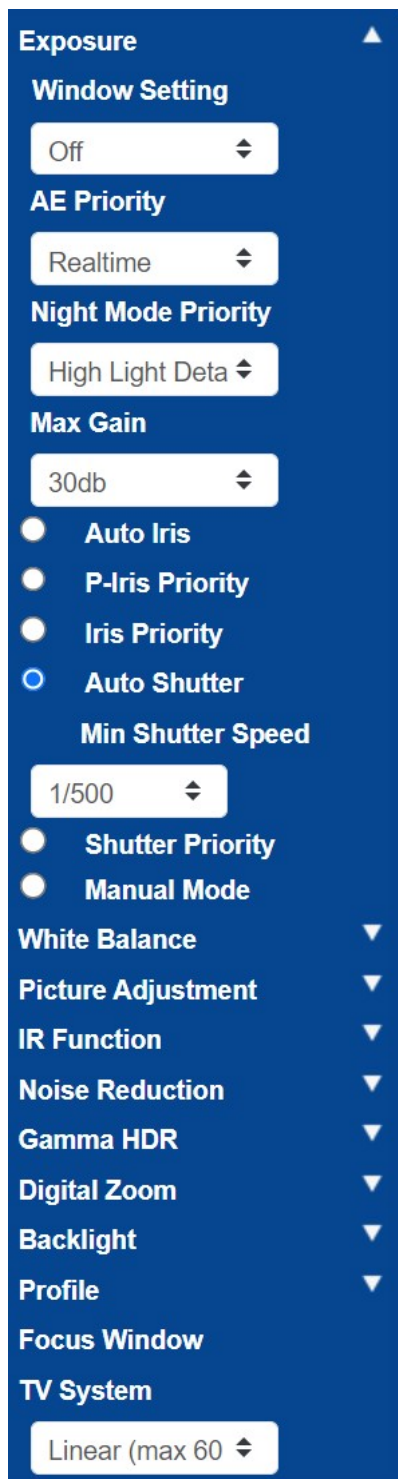

White Balance

Set Auto White Balance to Normal



Picture Adjustment

Set the Brightness and Contrast as required.

If using the camera at greater distances (20m+) at night, it may help to slightly increase the contrast by +1 or +2 to brighten the plates. (Additional gain may help also – see above.)

It is best NOT to enhance the sharpness of the image as this is interfering with the original image.

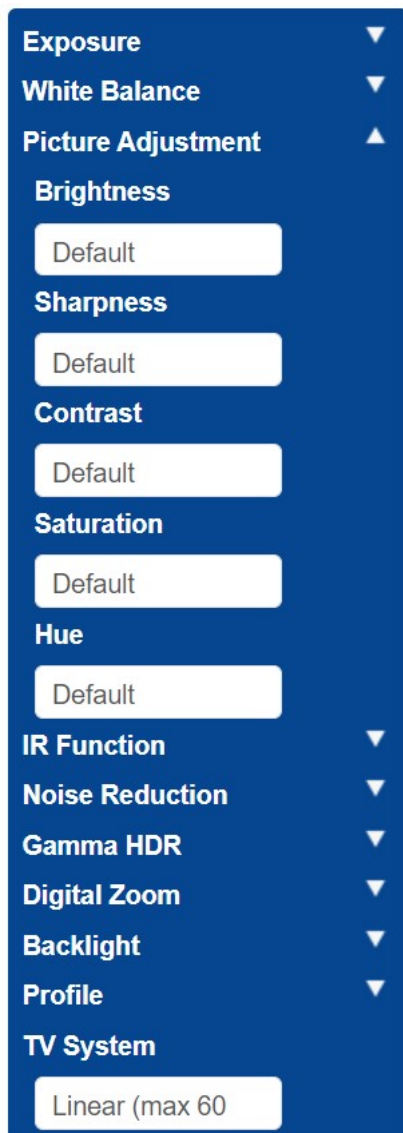

IR Function

Set the IR to use the integrated Light Sensor to determine when it is dark, and the camera should switch to night mode and illuminate the IR LEDs.

The thresholds determine at what light level the camera changes. This may vary due to reflections from buildings or objects or ambient light in your scene.

Night Mode to Day Mode

The lower the value, the earlier the camera switches to Day mode. The default value is 7. So, if you want to change to Day Mode later, then increase this value.

This can help if the camera refocuses and has very little to focus on as the image is still dark.

Day Mode to Night Mode

The higher the value, the earlier the camera switches to Night mode. The default value is 4.

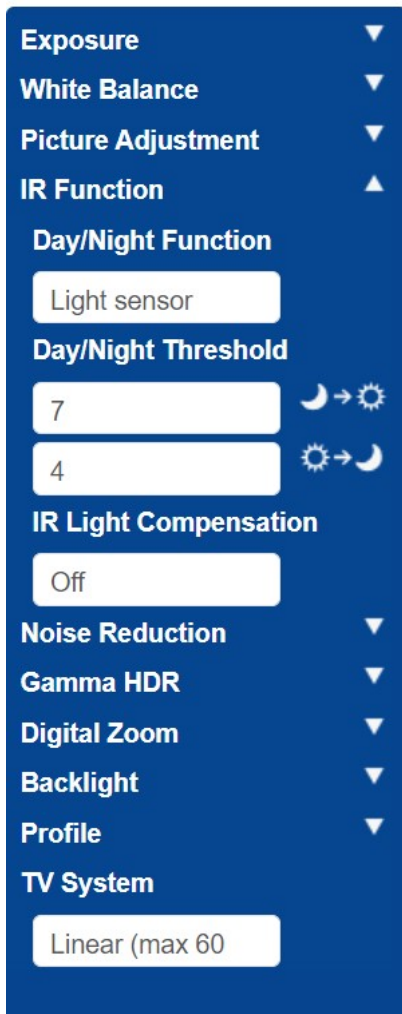

Noise Reduction

2D Noise Reduction is recommended (3D combines frames and so should not be used)

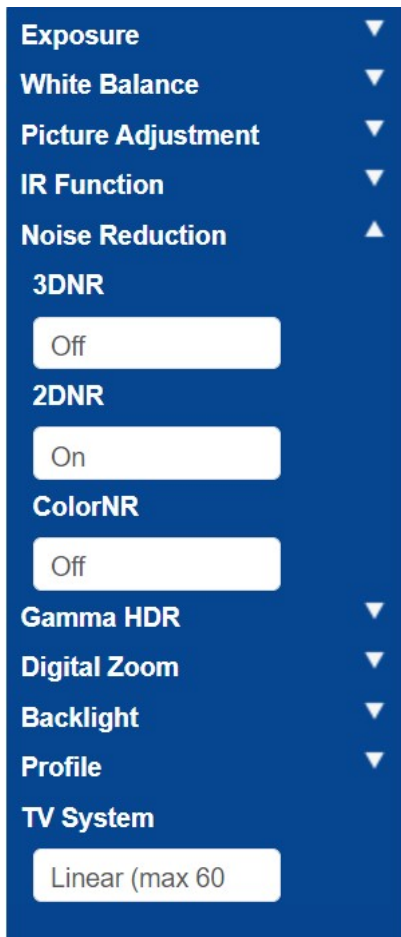

Gamma HDR

Turn Gamma HDR off as this combines frames.

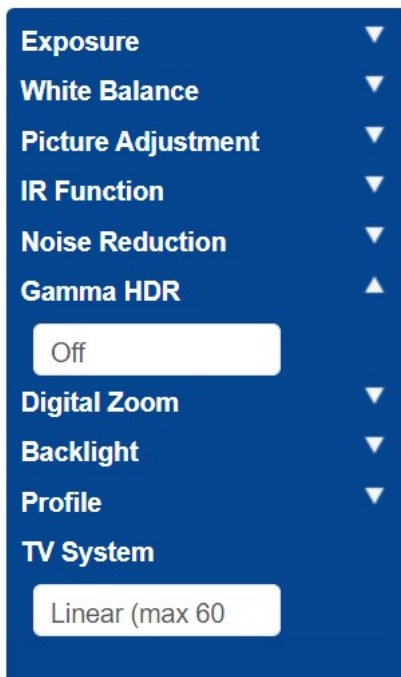

Digital Zoom

Turn Digital Zoom off; use the optical zoom if required.

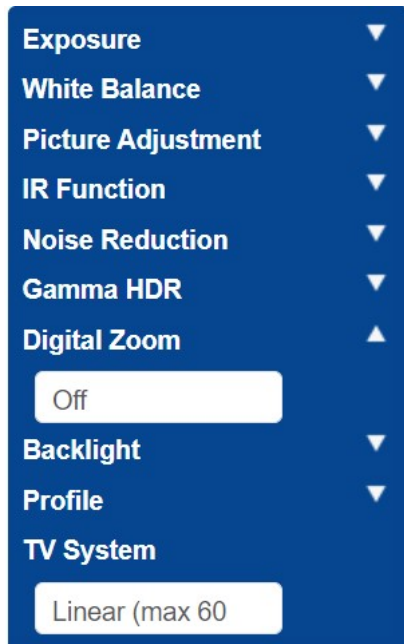

Backlight

Turn Backlight Exposure Off.

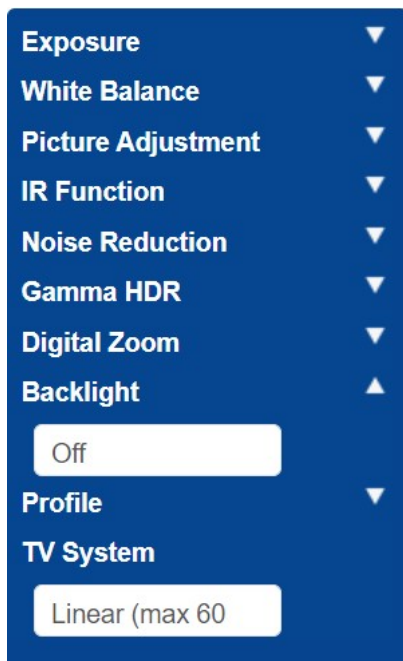

Profile

You can set and save various Camera Profiles if required.

The tick icon  saves the current profile.

To load and apply a profile, select a profile number, and use the load icon .

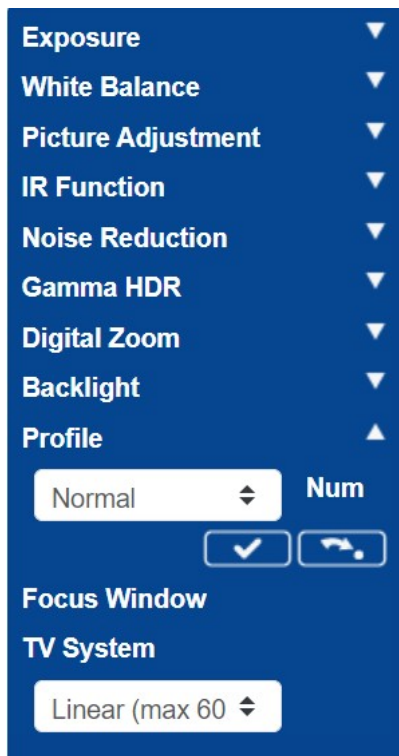

TV System

The TV system is normally only used if you connect an analogue CCTV monitor to it (PAL or NTSC). This is not normally required – so set this to Linear 60 and this will allow using higher shutter speeds.

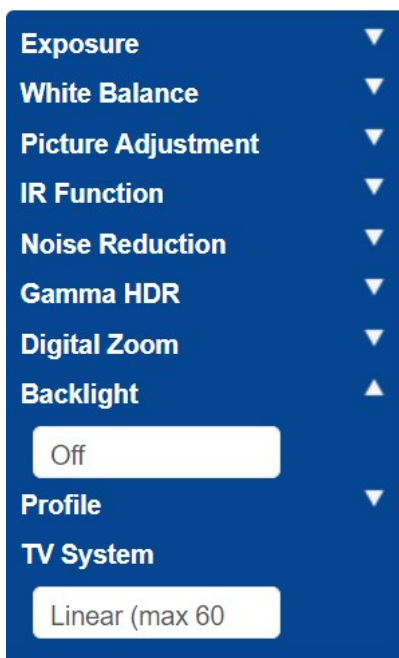

Test the above settings by running through the scenario with a vehicle. For best results, test the settings in the darkest lighting conditions. This way, you get a good result both during nighttime and daytime.

Licensing ALPR

ALPR software with Make, Model & Color recognition should already be installed on your MOVE camera. This includes the product key (license) that is required to use the software. If, for any reason, you need to apply a different product key, follow the instructions in this section.

Once installed, open the camera's ALPR page: <http://<IPAddress>/mobotix/index.html>

The tab title at the ALPR page will show the version number and the build number. Both should match the expected values for the current release.



VaxALPR 1.0.8 [26717]

There are two methods of licensing the software:

1. [Online Licensing, p. 127](#), if your camera is connected to the Internet (recommended).
2. [Offline Licensing, p. 130](#), if your camera is not connected to the Internet.

Online Licensing

Ensure that the date & time of the camera are correctly set. Using a NTP server is not mandatory and synchronizing the time with the computer is a valid method.

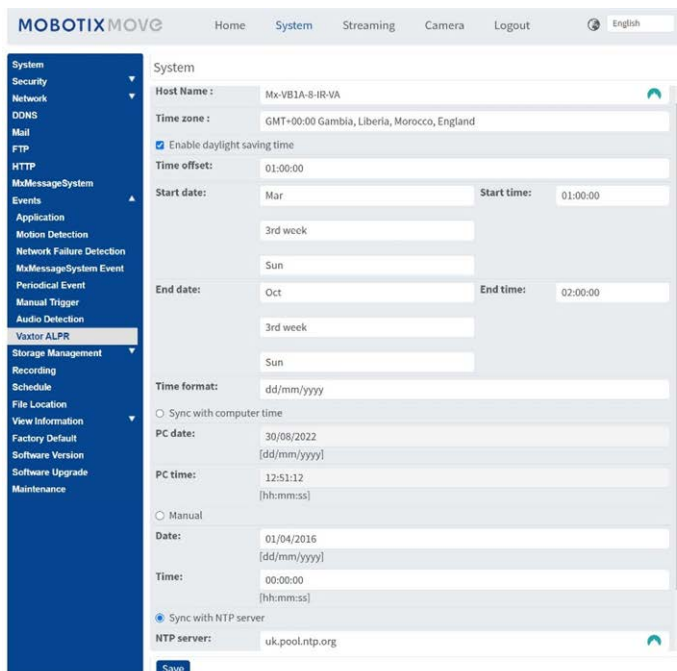

ALPR Best Practices

Licensing ALPR

Ensure that the network setup is correctly set. The camera must have a correct DNS server configured, to do this go the main MOVE System menu and select Network & Basic.

Select a DNS server such as: 8 . 8 . 8 . 8 with a secondary server of 8 . 8 . 4 . 4, for example. These are free Google DNS servers which will map your URL names.

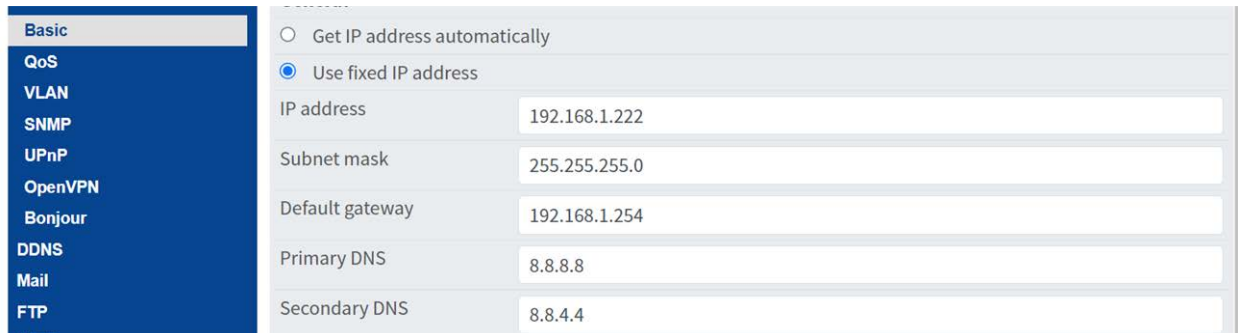

The screenshot shows a network configuration menu on the left with options: Basic, QoS, VLAN, SNMP, UPnP, OpenVPN, Bonjour, DDNS, Mail, and FTP. The main configuration area is for network settings. It has two radio buttons: 'Get IP address automatically' (unselected) and 'Use fixed IP address' (selected). Below are input fields for IP address (192.168.1.222), Subnet mask (255.255.255.0), Default gateway (192.168.1.254), Primary DNS (8.8.8.8), and Secondary DNS (8.8.4.4).

Select the ALPR page from System > Events:

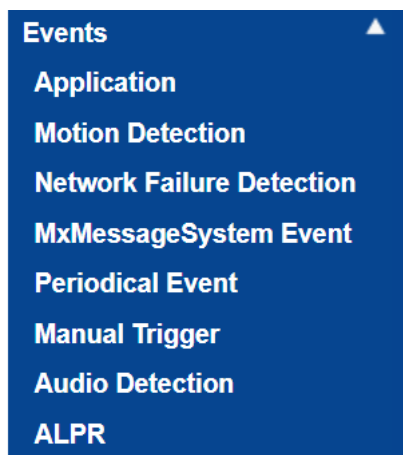

The license dialog box will appear:

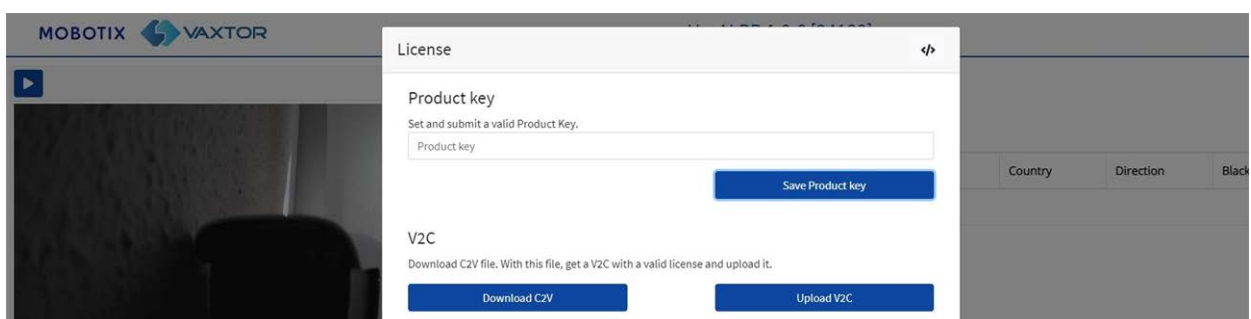

The screenshot shows a 'License' dialog box with a close button in the top right. It contains two sections: 'Product key' with a text input field and a 'Save Product key' button; and 'V2C' with instructions 'Download C2V file. With this file, get a V2C with a valid license and upload it.' and two buttons: 'Download C2V' and 'Upload V2C'. The background shows a camera feed and a table with columns 'Country', 'Direction', and 'Black'.

In the 'Product key' box enter the product key provided.

This will be a code formed by 5 groups of letters and numbers such as:

c9641677-4881-4283-9f42-cb169cb55b98

Click on the button **Save product key**. The window should change to:

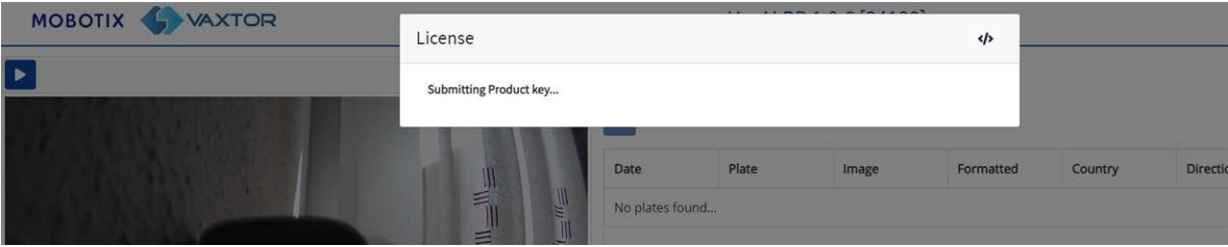

If the licensing has worked correctly then you will be redirected to the main ALPR software Plates page:

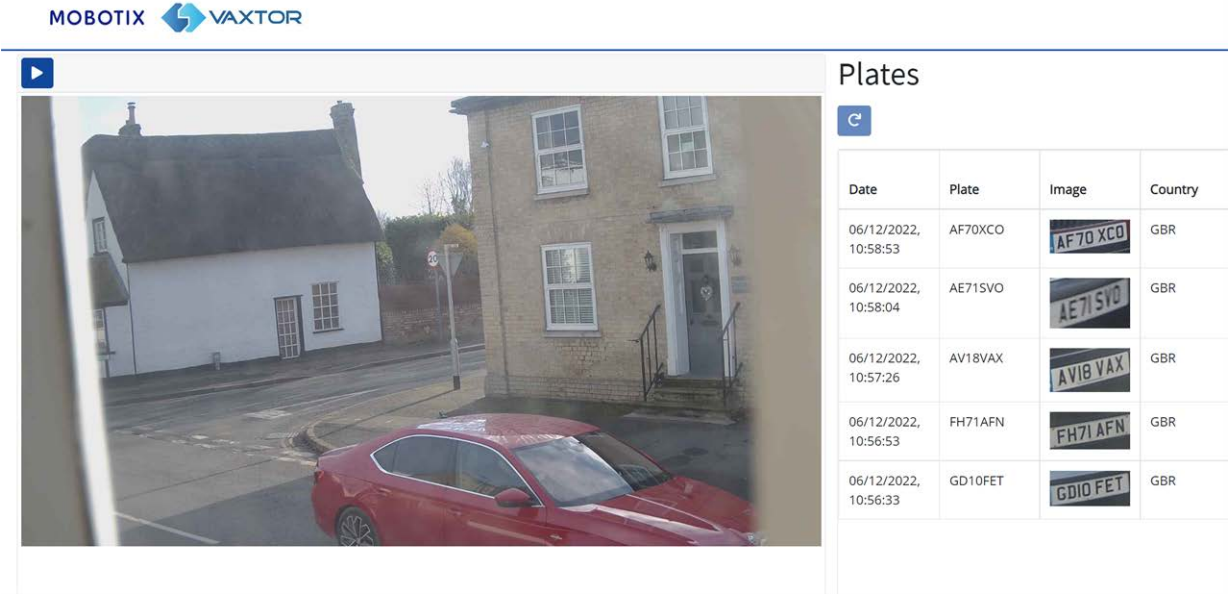

In the case that there has been an error, a descriptive message will appear at the bottom right corner of the screen:

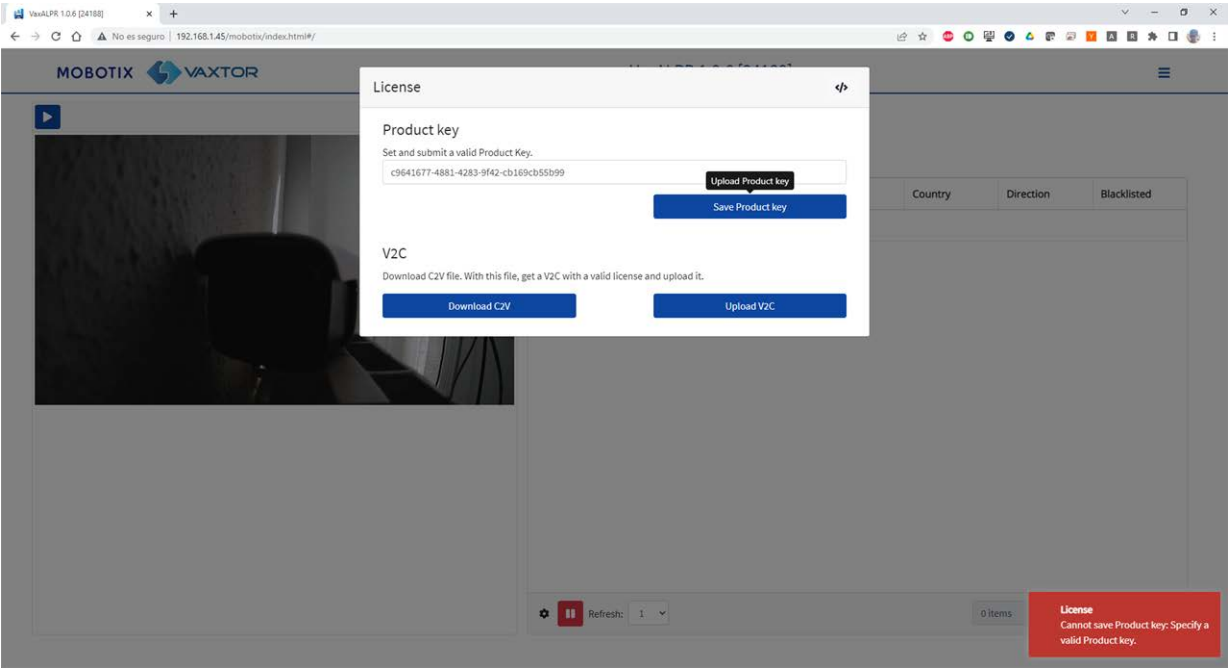

Details of the error can be checked on the logfile. To open the log, click on the “</>” symbol on the top right corner of the licensing window.

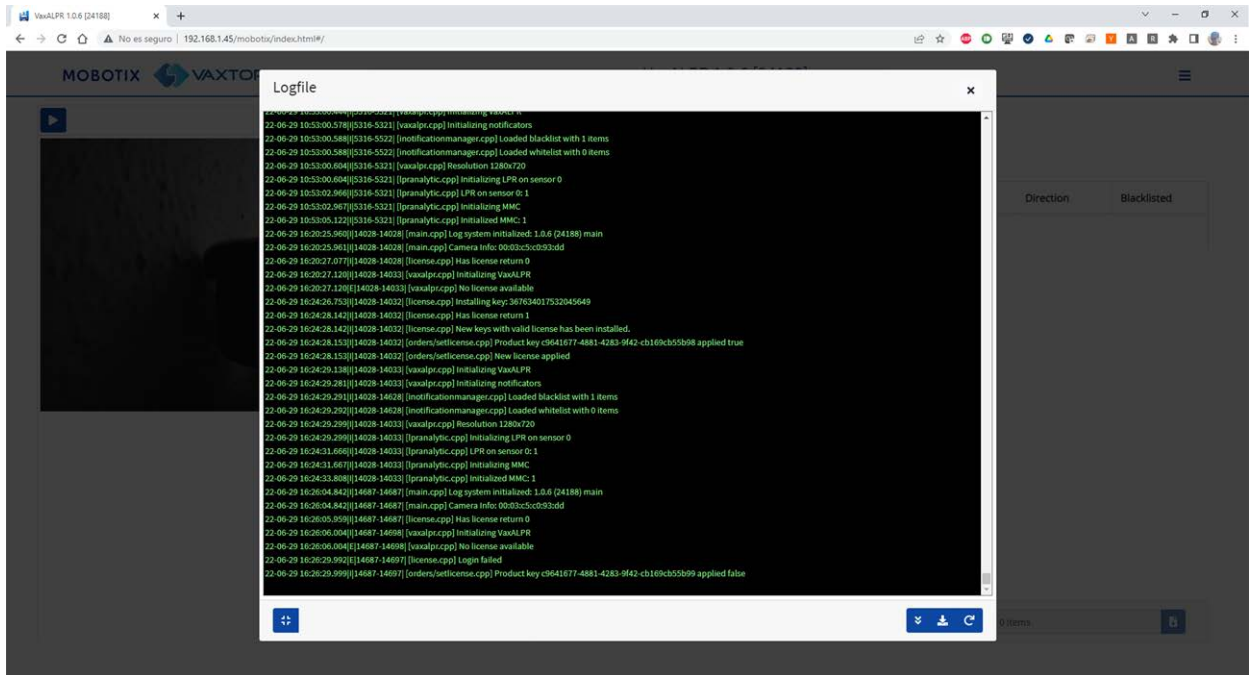

Offline Licensing

Open the ALPR page on the camera <http://<IPAddress>/mobotix/index.html>. The license dialog box will appear.

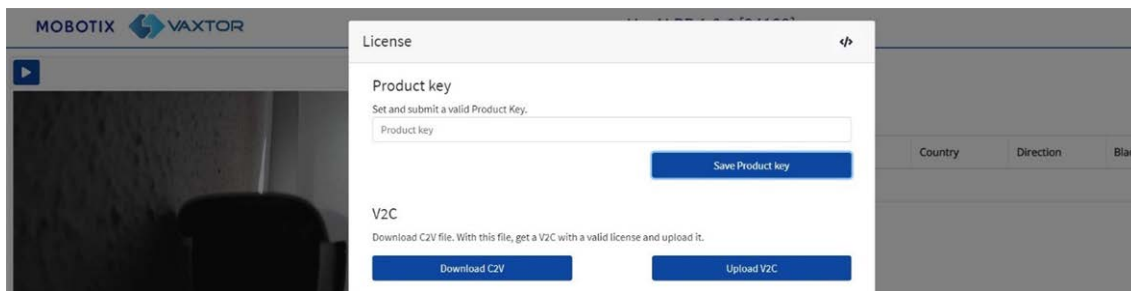

Click on the 'Download C2V' button. A C2V file will be saved to your download directory.

Next using your web browser go the licensing portal <https://licensing.vaxtor.com> and enter your product key in the textbox. Click on **Log In**.

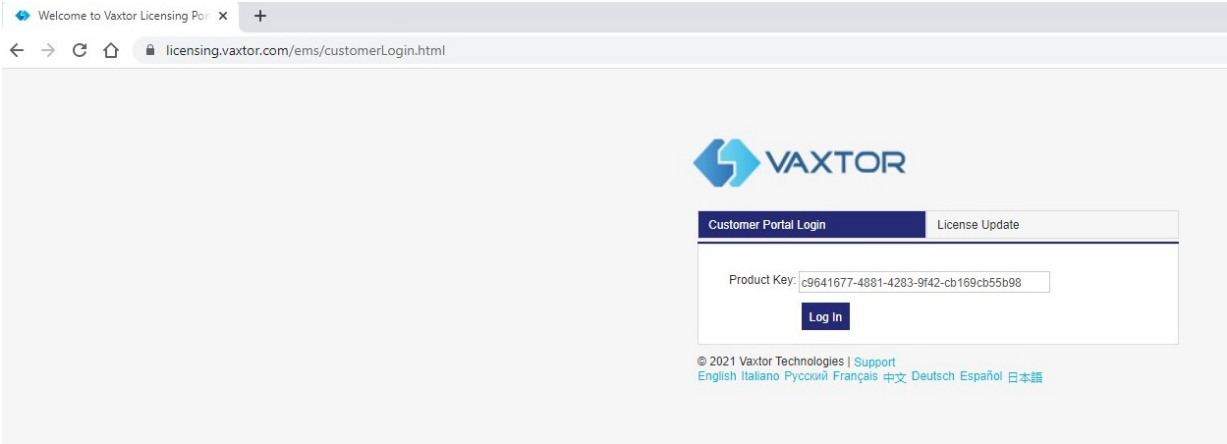

If a customer window appears, click on **Register Later**.

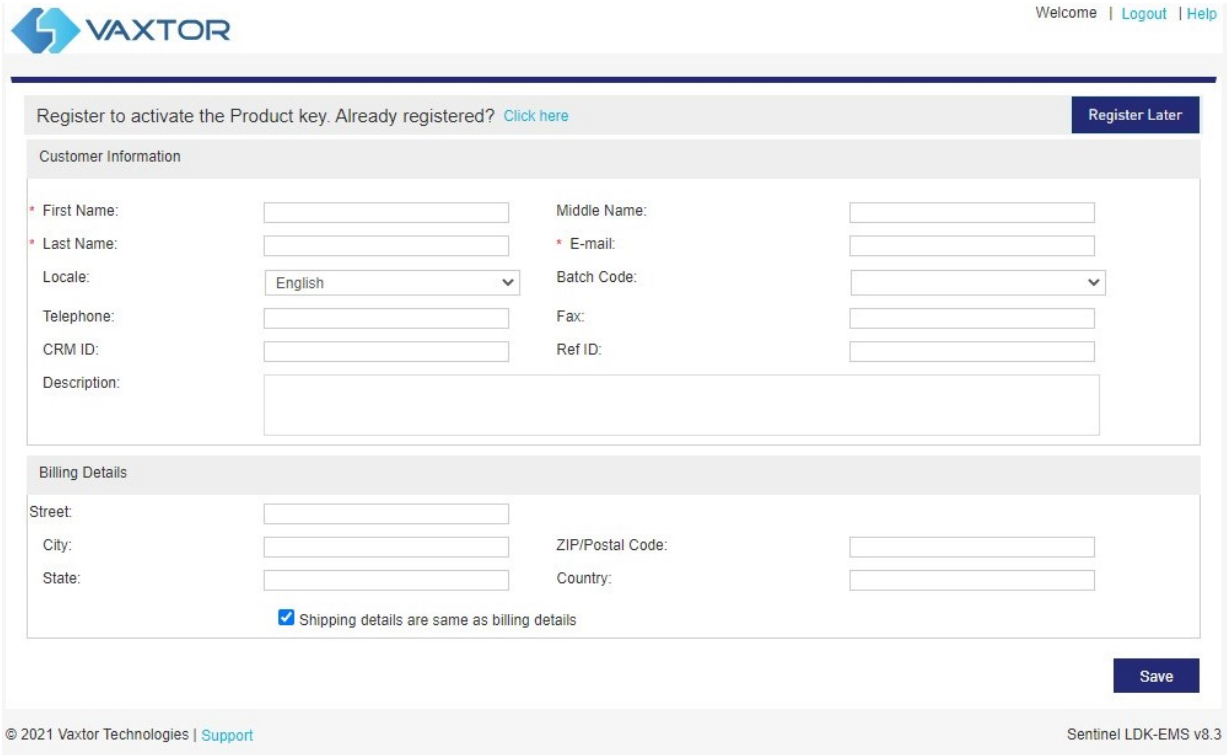

Click on **Offline Activation**.

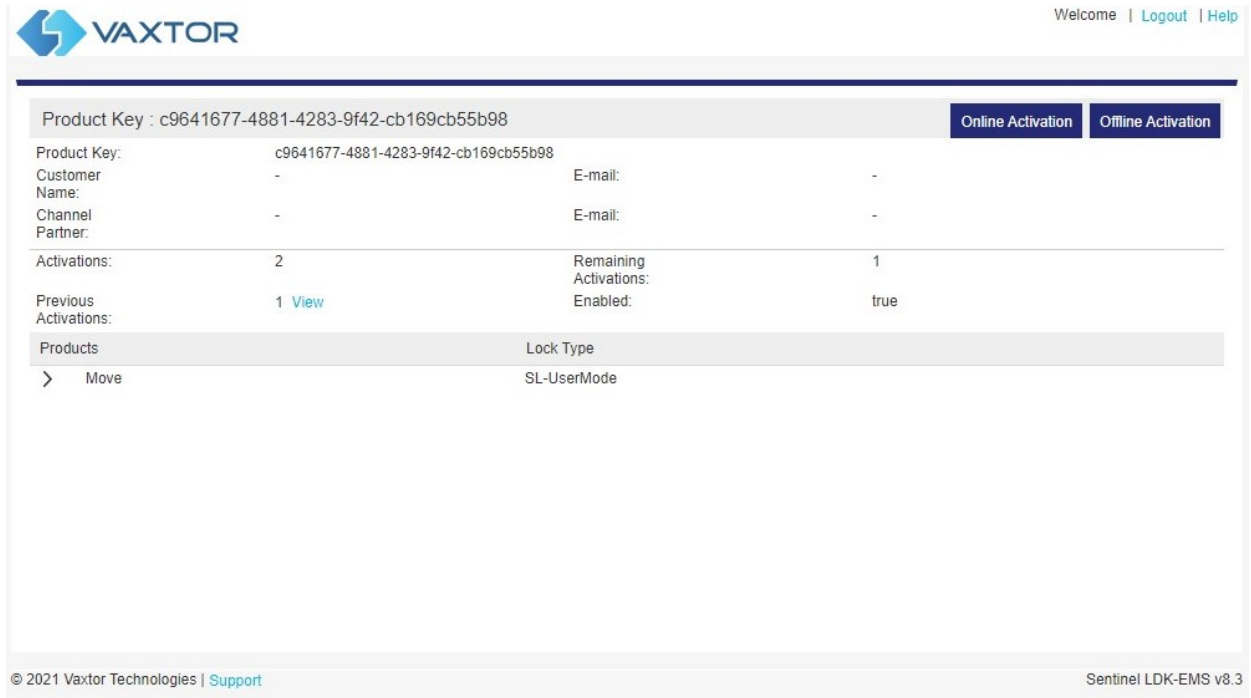

The screenshot shows the Vaxtor web interface. At the top left is the Vaxtor logo. At the top right are links for 'Welcome', 'Logout', and 'Help'. Below the header is a product key: 'c9641677-4881-4283-9f42-cb169cb55b98'. To the right of the product key are two buttons: 'Online Activation' and 'Offline Activation'. Below the product key is a table of product details:

Product Key:	c9641677-4881-4283-9f42-cb169cb55b98		
Customer Name:	-	E-mail:	-
Channel Partner:	-	E-mail:	-
Activations:	2	Remaining Activations:	1
Previous Activations:	1 View	Enabled:	true

Below the table is a section for 'Products' and 'Lock Type':

Products	Lock Type
> Move	SL-UserMode

At the bottom left of the interface is the copyright notice: '© 2021 Vaxtor Technologies | [Support](#)'. At the bottom right is the version number: 'Sentinel LDK-EMS v8.3'.

Click on the '...' button and upload the **C2V** file downloaded earlier.

Click on 'Generate' go generate a **V2C** file.



Generate License ? X

Order Details

Product Key: c9641677-4881-4283-9f42-cb169cb55b98

Customer: - E-mail: -

Activations: 2 Remaining Activations: 1

Vaxtor Ref: #PO Ref:

Entitlement
Comments:

Products:	Product	Lock Type
	Move	SL-UserMode

Download [RUS](#), a tool to generate C2V

Upload C2V

Upload C2V:

Comments:

Download the V2C file by clicking on the blue link.

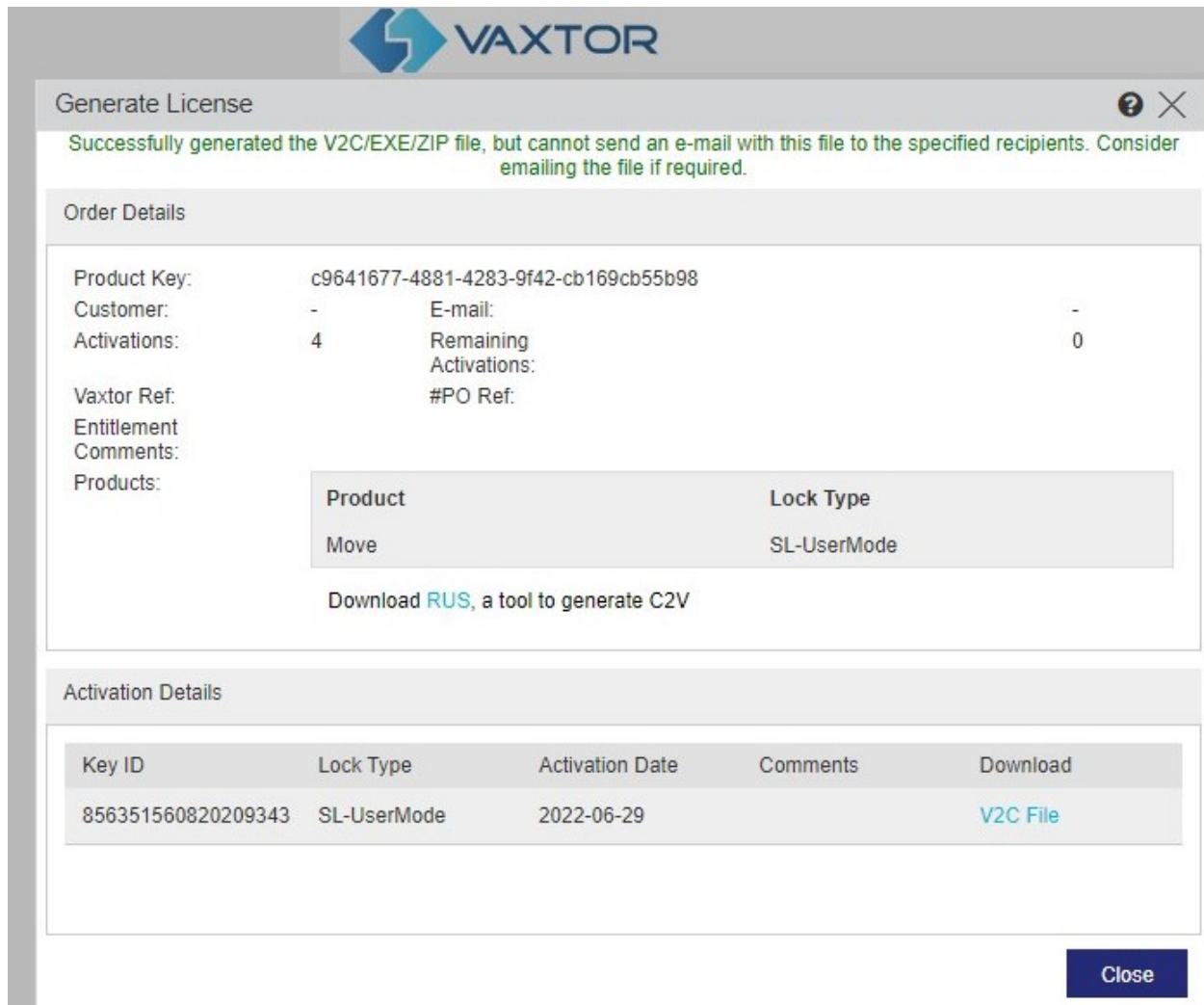

VAXTOR

Generate License ? ×

Successfully generated the V2C/EXE/ZIP file, but cannot send an e-mail with this file to the specified recipients. Consider emailing the file if required.

Order Details

Product Key: c9641677-4881-4283-9f42-cb169cb55b98
Customer: - E-mail: -
Activations: 4 Remaining Activations: 0
Vaxtor Ref: #PO Ref:
Entitlement
Comments:
Products:

Product	Lock Type
Move	SL-UserMode

Download [RUS](#), a tool to generate C2V

Activation Details

Key ID	Lock Type	Activation Date	Comments	Download
856351560820209343	SL-UserMode	2022-06-29		V2C File

[Close](#)

Return to the camera's licensing page (<http://<IPAddress>/mobotix/index.html>) and click on **Upload V2C**.

Select the file downloaded on the previous step.

The camera will redirect you to the Settings page and a confirmation message will appear at the bottom right corner.

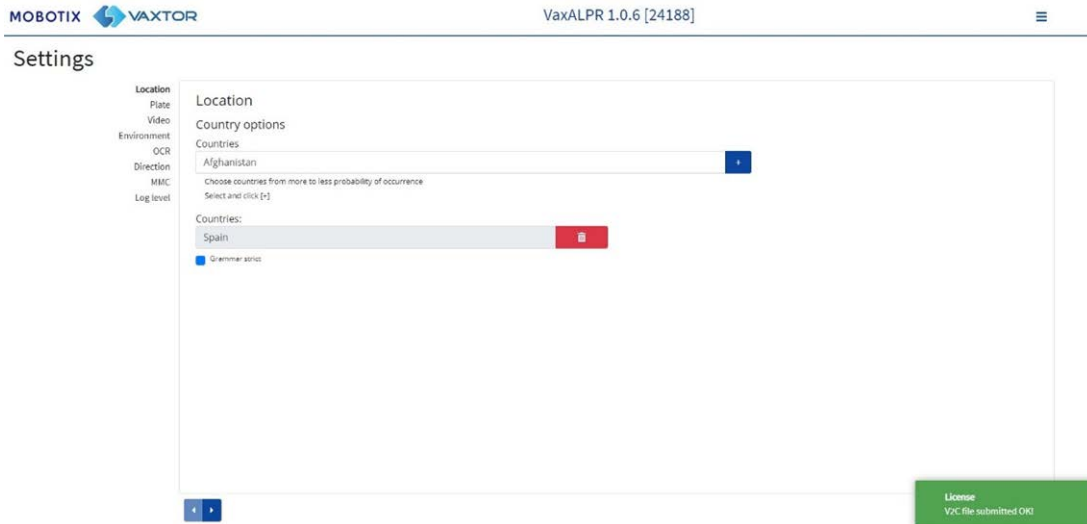

Starting the ALPR software

Once licensed, go to the camera's ALPR page by doing one of the following.

- Select **ALPR** from **System > Events**.
- Open <http://<IPAddress>/mobotix/index.html>

ALPR user interface

This will open a new window with the ALPR main interface.

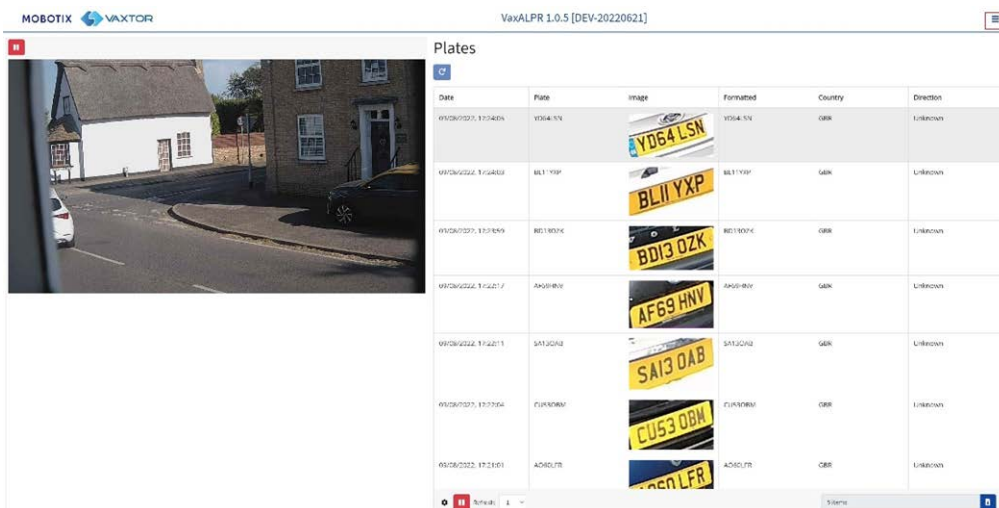

Fig. 4: ALPR user interface

The icon in the top right corner reveals the options menu including:

- **Plates:** To display a live feed of all the most recent plates read (if configured).
- **Settings:** To configure ALPR software.
- **Region of Interest (ROI):** To add/edit ROIs to include or exclude in the OCR analysis.
- **Reporting:** To configure reporting options for ALPR.
- **Blacklist:** To manage a blacklist (e.g. to sound alarms).
- **Whitelist:** To manage a whitelist (e.g. to activate a relay; these appear if they have been enabled in Settings).
- **Database:** To review and search the list of recorded plates (If configured).
- **Download (XML) Config:** To export the ALPR settings to an XML file.

The export will not include the black/whitelists or the recorded log file of plates.

- **Upload XML Config:** To import the ALPR settings from an XML file.
- **Logfile:** To display the latest System Log for debugging purposes.
- **System update:** To update the ALPR software to the latest version.

Live Video Button

When the GUI starts, a single image is grabbed from the camera and frozen for you to select from the menu or view captured plates. Press the Blue Play icon to start the live video.

If you do not need to see live video then press the Red Pause icon.

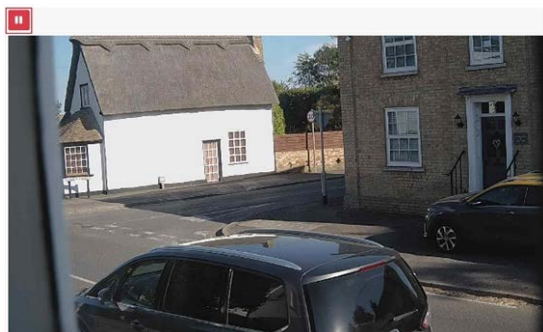

NOTE! If you are using a 4G connection to the camera, then by viewing a live image in a browser window you will be streaming data over your connection to your PC for which you may be charged for.

Configuring ALPR

This section covers everything you need to know about configuring and updating your ALPR system.

ALPR Settings

In the ALPR **Settings** page it is possible to configure all of the LPR parameters. The settings are divided into different sections.

NOTE! The version/build number is shown in the web page title tab:

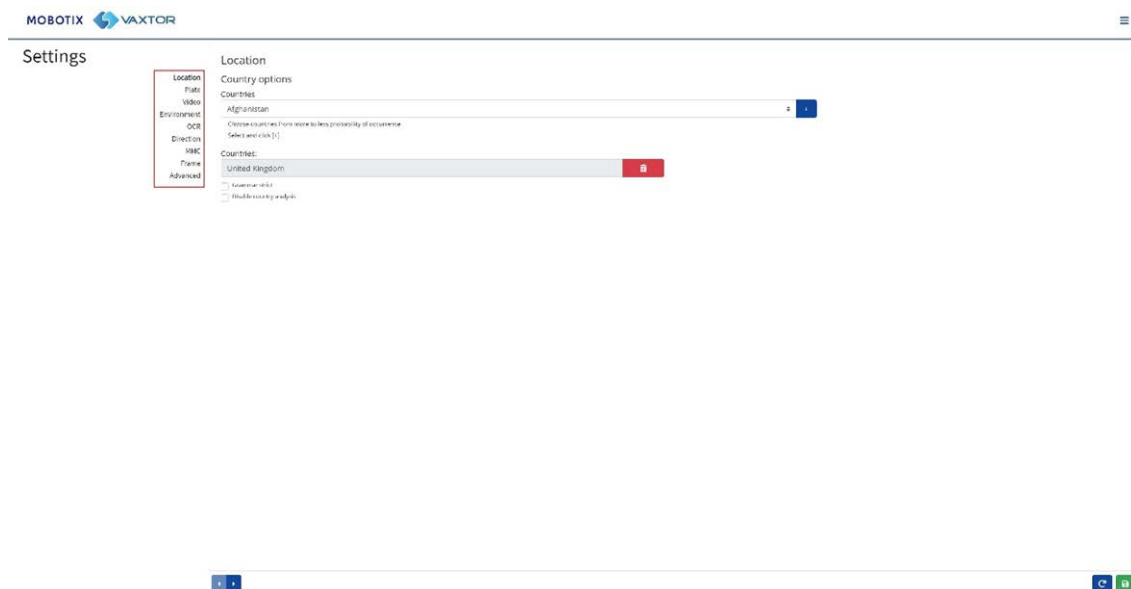
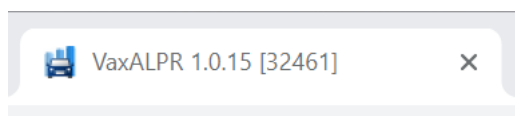

Select each section in turn from the headers on the left or move between them using the left and right arrows at the bottom of the screen: 

You can abandon your edits and reload the currently saved configuration file by clicking the Reload symbol, bottom right:

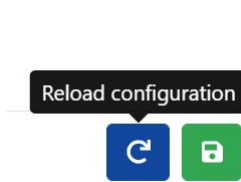

You can also save the current settings at any time by clicking on the disk symbol, bottom right:

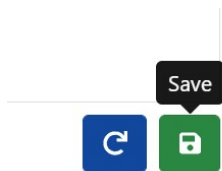



(See [ALPR Settings: Save changes](#), p. 156.)

ALPR Settings: Location

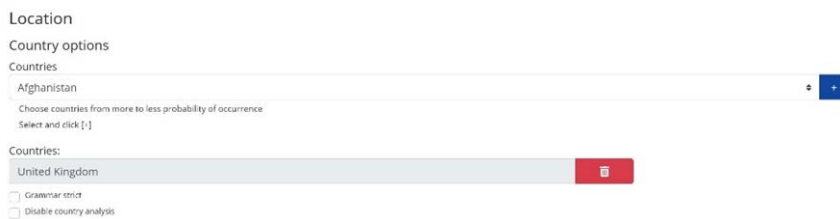
Countries (1-10)



At least one country must be selected and up to ten countries may be included.

- Select a country from the drop-down list and click the  button. The country will be added to the list.
- To remove a country from the list, click the  button.
- Additional countries will be added to the bottom of the list. Make sure that the list is ordered so that those countries with the higher probability of occurrence appear first. (Tip: Think about this first and then add the countries one-by-one. If you make a mistake you will have to delete one or more entries and add them again.)

Required State (1-5)

Location

Country options

Countries

United States

Choose countries from more to less probability of occurrence
Select and click (*)

Countries:

Canada

United States

States:

Alabama

Alaska

Arizona

Arkansas

California

Colorado

Connecticut

Delaware

District Columbia

Florida

Georgia

Hawaii

Idaho

Illinois

Indiana

Iowa

Kansas

Kentucky

Louisiana

Maine

If one of selected countries is United States, a main state must be selected from the drop-down menu. A total of five states can be added – again in likely order of occurrence.

NOTE! The same neural engine (used for matching character shapes) is used for all of the Americas, selecting the state simple loads the possible syntax (grammar) for those states to help with the letter O and zero for example. Other states not in the list will still be recognized.

Grammar Strict

Grammar Strict

- Select this checkbox to force the Engine to only use the syntax from countries or states that you have selected. Plates that do not match these rules will not be reported. This is the recommended option for using ALPR for access control where exact matches are required.
- Do not select this checkbox when you want to report ALL valid license plates. This is the recommended option for ALPR in triggered mode (see).
- In the USA, plates are often seen from multiple States – and so the recommended setting is OFF.

NOTE! False triggering may occur when this checkbox is not selected. E.g., some text seen on the rear of a truck may be read as it doesn't match the selected grammar.

Disable country analysis

Disable country analysis

Select this checkbox to disable country analysis.

If enabled, country analysis uses machine learning to determine the country of origin of the plate, even if it is not in the list of countries selected above. The results are based on the image characteristics of the plate compared to an ever-growing database of international samples.

NOTE! This extra process will add some time to the OCR processing time. When tuning your system later note what effect this has.

ALPR Settings: Plate options

Plates

- Detect multiline
- Enable database
- Enable whitelist
- Enable blacklist
- Retry notifications
- Low coverage

Retry timer (1 - 60)

Background Mode

Minimum Number of Plate Characters (3 to 12)

Maximum Number of Plate Characters (5 to 12)

Detect multiline plates

Detect multiline

- Some countries or regions do not have two or three-line plates. If this is the case, unticking this option will allow the engine to run faster.

Database

IMPORTANT: To save recorded plates in the camera's storage for later retrieval or viewing, you must install and configure an appropriate SD card in the camera. This can be checked from the camera's System menu under Storage Management.

The application only checks for available space on the SD card when launched and if it becomes full then no new plate reads will be added to the database. There is a default maximum size of 100,000 records and when this limit is reached the oldest records will be overwritten.

NOTE! If you are using a small SD card then the card may to become full before this circular buffer limit is reached and so no new reads will be written to the card and so you should reduce this buffer size accordingly. There is no definite standard record size as this depends on video resolution, the complexity of the image, the jpeg compression factor used etc. As a rough guide a 32GB SD card would store approximately 80,000 reads at 1920h.

Enable database

Enable database

- To generate an on-board database (log file) of detected plates, select the 'Enable Database' checkbox. A maximum of 100,000 records may be stored in the database. The size of each image depends upon image complexity, resolution etc. but a 64GB SD card should store 100,000 reads and images on board.

Activate whitelists/blacklists

Enable whitelist

Enable blacklist

Enable whitelist

- Select this checkbox to enable plate checking against a predefined Whitelist.

Enable blacklist

- Select this checkbox to enable plate checking against a predefined Blacklist (see [ALPR Blacklists and Whitelists, p. 162](#)).

NOTE! Blacklists and whitelists can be stored centrally on MOBOTIX SYNC/Helix Back Office and automatically synchronized with all connected cameras.

Retry notifications

- Select this checkbox to retry the sending of any notifications if any fail, for example due to a communication problem. You may then specify a retry period in seconds (see [Retry Timer, p. 143](#)).

Low coverage mode (FIFO)

- Select this checkbox if your camera is remote and the communication links (WiFi or 3G for example) are regularly dropping out. When selected, events are not sent in real time to any configured Back Office or recipient (see [ALPR Reporting, p. 170](#)). In very bad conditions this would cause a backlog of events being constantly tried.

With Low Coverage Mode selected, reads are retransmitted after a longer interval reducing the chance of an ever-increasing backlog.

So the system will use a FIFO policy for sending reads.

NOTE! This should NOT be used when using UTMC protocol or when using the system for access control where real time events are essential.

Retry Timer

Retry timer (1 - 60)

- You may specify a retry period in seconds to retry the sending of any notifications if any fail, for example due to a communications problem (see [ALPR Reporting, p. 170](#)).

How retries work

Normally the transfer process takes approximately 100ms without image, and 300ms with image. If the response from the server takes more than 5 seconds, you will get a timeout error on the camera, BUT this does not mean the data hasn't arrived at the endpoint.

Usually this is caused by the server receiving the request and processing the data before sending the data received acknowledgement to the client (the camera). The data is already on the server, but the camera only waits 5 seconds for the response. This can cause the same data to be re-sent as the camera does not receive the OK response and the entry in the camera database is still marked as unsent. (or not received).

Check your endpoint software (back office) and ensure that responses are sent to the camera immediately after receiving the data before processing the data. Contact the manufacturer for further information.

Background Mode

Background Mode

- Select the option from the drop-down list that best defines the color of the target license plate. There are three possibilities:
 - **Dark foreground, light background:** The plate background color is lighter than the characters (e.g., black fonts on white background).
 - **Light foreground, dark background:** The plate background color is darker than the characters (e.g., white fonts on black background)
 - **Both:** Plates are expected in both forms.

NOTE! Do not select Both unless it you need to recognize both types as this can affect OCR performance.

Minimum Number of Plate Characters

Minimum Number of Plate Characters (3 to 12)

- Set the minimum number of characters that you expect to see in your region.

Maximum Number of Plate Characters

Maximum Number of Plate Characters (5 to 12)

- Set the maximum number of plate characters that expect to see in your region.

ALPR Settings: Video

Video



Resolution
1920x1080

Minimum Character Height (1-75 pixels)
25

Maximum Character Height (1-20 pixels)
70

This section displays real-time video based on the current settings. When some parameters are edited such as resolution, the changes are immediately reflected in the video stream.

Play/pause video



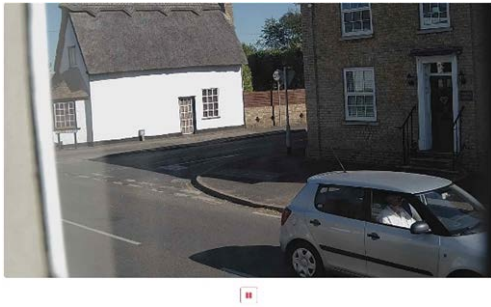

To select a suitable image to verify the Character Height configuration, you can pause the video reproduction, using the play/pause button at the bottom of the image.

Setting the Proper Resolution

Select the desired Resolution from the drop-down list. Any changes will immediately be shown on the live display. Some cameras have a limited choice of available resolutions.

NOTE!

- When the camera is setup to read plates in a single lane then a resolution of 1024x768 or 1280x720 is recommended. When the camera is setup to read plates in wide or multiple lanes, a resolution of 1920x1080 is recommended. Not all options may be available.
- When trying to detect license plates that are close to the camera, you may have to reduce the resolution (see below).

Minimum Character Height (14-70 pixels)

This is the minimum height that a license plate's characters should be before being read. If the camera's lens (zoom) is setup correctly then the plate characters should be about 20-30 pixels high in the field of view where they should be read. Set this too small and the tiny plates will cause mis-reads.

NOTE! For small plates such as most Arabic plates - or plates with additional small characters such as Costa Rica, a minimum character pixel height of 30 pixels is recommended.

- Set the minimum height of the plate's characters in pixels.

NOTE! The recommended difference between the min and max heights is about 10-20 pixels.

Maximum Character Height (14-70 pixels)

- Set the maximum height of the plate's characters in pixels.

Verifying the Character Height configuration

To verify that the height settings are correct, click over the live video to show two rectangles which represent the minimum and maximum thresholds. The height of characters on the plate should fall

ALPR Best Practices

Configuring ALPR

within these two rectangles. You can drag these rectangles around the screen to where your target plates are.



Minimum Character Height (14-70 pixels)

20

Maximum Character Height (14-70 pixels)

40

ALPR Settings: Environment options

Environment

Same Plate Delay (seconds)

30

Same Plate Max Chars Distance

1

Maximum Slope Angle (0-40 degrees)

20

Mutiplate frame

Middle capture

Mutiplate minimum number of occurrences (1-10)

1

Mutiplate maximum number of occurrences (1-10)

5

Mutiplate recognition timeout (0-10000 milliseconds)

900

Same Plate Delay (Max: 65535 seconds)

Same Plate Delay (seconds)

Set the number of seconds that should elapse before reading the same plate twice.

This is to prevent multiple reporting of the same plate in situations when the traffic is slow or stationary. For example, if a vehicle stops at a barrier and the plate is reported but the car doesn't move for 30 seconds, then this delay should be set to 60 seconds, for example, or more to prevent a duplicate read.

Same Plate Max Chars Distance

Same Plate Max Chars Distance

- Set the number of characters that two plates must differ by to be considered different. The MOBOTIX MOVE camera is capable of reading a plate several times as it passes through the field of view. If one character is misread on one of the reads, set this value to 2 so both reads will contribute towards the final reported plate text.

Maximum Slope Angle (0-40 degrees) (Advanced option – Default 20)

Maximum Slope Angle (0-40 degrees)

- Set the angle of slope of a plate that the engine should attempt to read up to



NOTE! If you know that the plates will be skewed then by setting this parameter higher you can force the engine to look for plate shapes that are more skewed. However, you should setup your ALPR camera to keep plates as close to the horizontal as possible.

Multiplate frame reported

Multiplate frame

Middle capture	▼
First capture	
Middle capture	
Last capture	

- **Select which plate image should be saved from the drop-down list:**
 - First capture.
 - Middle capture.
 - Last capture

A plate is normally read several times as it passes through the camera's field of view. You may want to use the largest (Last) image for oncoming traffic & the First image for vehicles moving away from the camera.

Multiplate minimum number of occurrences (1-10)

Multiplate minimum number of occurrences

- Set the minimum number of times that a plate should be read within the Timeout period to be considered a valid plate.

Multiplate maximum number of occurrences (1-10)

Multiplate maximum number of occurrences

- Set the maximum number of times that a plate should be read before being reported (this may happen before the timeout).

Multiplate Recognition Timeout

Multiplate recognition timeout (0-10000 milliseconds)

- Set the number of milliseconds that the engine should spend analyzing a plate (1000 milliseconds = 1 second).

In free-flow mode the engine continuously analyses video frames and reads and reports plates. It makes a final decision on the plate read after an interval of time - the maximum recognition timeout period. There is a dedicated time counter for every plate which starts counting after the first read. When it reaches the preset timeout it stops, checks the number of samples read of the same plate and returns the **best** result.

If an instantaneous plate read is not needed, then set this timer to 1000ms (1 second), for example, so that the engine continues to look for the same plate to read again for as long as possible. Note that if a new plate is spotted during this time, the old one will be reported, and a new plate-trace started.

We call the number of times the same license plate has been read within the maximum recognition period the multiplate rate. Several reads of each plate are good and produce better results.

ALPR Settings: OCR options

OCR

Minimum Global Confidence (0-100)
70

Minimum Character Confidence (0-100)
50

Minimum Country Confidence (0-100)
50

OCR complexity
LOW

Working mode
Freeflow

Enable IR Mode (discard color information)

Minimum Global Confidence (0-100)

Minimum Global Confidence (0-100)
80

Minimum Character Confidence (0-100)
70

- Set the minimum confidence level that the whole plate read must meet to be accepted. The global confidence is the average of all individual characters' confidences. The recommended value is 80. Set lower if you see some plates in very bad condition but want to read them. (Setting this too low will cause the engine attempt to read other items such as vehicle signage etc.)

Minimum Character Confidence (0-100)

Minimum Global Confidence (0-100)
80

Minimum Character Confidence (0-100)
70

ALPR Best Practices

Configuring ALPR

- Set the minimum confidence level that a single character must meet to be accepted. The recommended value is 70.

TIP: In regions with open grammars such as the USA keep these two values high, e.g., 90-80 respectively. Higher values mean a lower probability of false positives but a lower probability of missing plates.

Minimum Country Confidence (0-100)

Minimum Country Confidence (0-100)

50

- Set the minimum confidence level to be applied when using automatic country analysis (see [ALPR Settings: Location, p. 139](#)). The default value is 50%.

OCR Complexity

OCR complexity

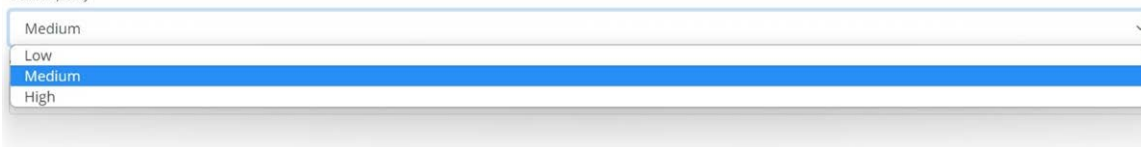

A screenshot of a dropdown menu for 'OCR complexity'. The menu is open, showing three options: 'Low', 'Medium', and 'High'. The 'Medium' option is currently selected and highlighted in blue.

This is the complexity of the analytics to be applied during the ALPR Engine's stage of plate reading. Set this according to the OCR mode and type of traffic expected.

There are three possibilities:

- **Low:** Recommended for very high-speed traffic where the OCR needs to work faster and your preference is for plate detection over perfect recognition.
- **Medium (Default):** Recommended when the OCR mode is set to free-flow.
- **High:** Recommended when the OCR mode is set to signaled (triggered.)

NOTE! Higher complexities give more accurate reading but make the ALPR engine run slower.

Working mode selection

Working mode

Working mode

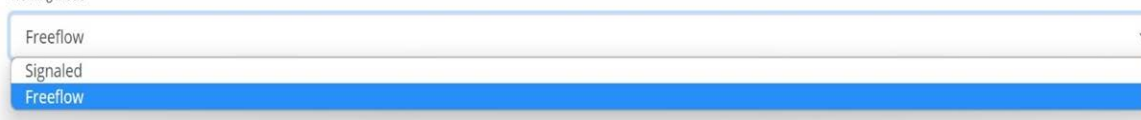

A screenshot of a dropdown menu for 'Working mode'. The menu is open, showing two options: 'Freeflow' and 'Signaled'. The 'Freeflow' option is currently selected and highlighted in blue.

- Select the appropriate option from the drop-down list. There are two options:
 - **Free flow:** The system continuously analyzes the video and reports plates when detected. This is the normal mode of operation.
 - **Signaled:** The system only analyzes the video when a trigger is received.
- If Working Mode selected is set to 'Signaled', a port may be specified.

Working mode

Signaled

Trigger on port activation

Port

0

- If when triggered, no plate is found in the field of view, then the word 'NONE' will be transmitted as the plate read.

Signaled Mode

You might use signaled mode in high security scenarios when you are able to detect a vehicle (by a loop or beam for example) and you want to capture an image even if there is no plate or a damaged or disguised plate; in this case you could use a physical port.

In signaled mode, if the software cannot find a plate in the image it will return the plate as **NONE** along with all the normal meta-data including the id of the signaling source.

Enable IR Mode (discard color information)

- Enable IR Mode (discard color information)

Enable this mode to only analyze plates in monochrome (from the green channel).

This speeds up the OCR processing time as less data has to be manipulated but all saved and transmitted images are subsequently in monochrome.

ALPR Settings: Vehicle Direction Filters

Direction

- Report vehicles moving away
- Report vehicles approaching
- Report vehicles with unknown direction

If the camera is pointing at a road or entrance where traffic is moving in both directions, then by ticking the boxes you can choose to only process/report plates in one direction. Note that at least two reads of a plate must have been obtained to determine the direction. If a car is maneuvering or stopped (or moving so fast that you only capture the plate once), then by also selecting 'Report vehicles with unknown direction' you will ensure that all required plates are captured.

Select all three options for normal usage.

ALPR Settings: MMC and Vehicle Classification

MMC and Vehicle Classification is included with the MOVE version of the ALPR software which adds a Make, Model and Color recognition capability to the ALPR along with the Vehicle Class. They can be used separately or alongside each other.

Make-Model-Color

Minimum Confidence (0-100)

50

MMC Mode

None	▼
None	
MMC	
Classification	
Both	

When MMC is enabled, the engine will find a plate and the MMC analytic will attempt to identify the make model and, if possible, the color of the vehicle using Deep Learning technology.

The software recognized approximately of 680 car manufacturers and 7,250 models and can recognize make, model, color from both front and rear views to a very high accuracy. The engine does not require any calibration and automatically determines the orientation of the vehicle. The software will report up to 11 colors but note that colors are often distorted by lighting and reflection on a vehicle.

Vehicle Classification or VClass should be used cameras that are setup to not only read the plate but show as much of the front or back of the vehicle as possible at a reasonably shallow angle. The software will report vehicle types including motorcycle (if it has a plate), car, pickup, van, truck, and bus.

- Select MMC/Classification or both analytics.

In the Plates or Database menu you can use the settings icon to display the MMC & Class data:

Plates



Date	Plate	Image	Formatted	Char height	Make	Model	Color	Class
30/08/2022, 10:19:39	FE12EMF		FE12EMF	18	Toyota	Auris	Black	
30/08/2022, 10:19:34	YK67LCW		YK67LCW	20	Mazda	2	White	
30/08/2022, 10:19:26	MF22UUX		MF22UUX	21	Ford	Transit Custom	Black	

Frame Options

This section allows the user to control the image compression and define a watermark for the saved/transmitted images.

Frame Options

JPG Compression Quality (1 - 100)

80

Crop Images

Crop Width (640-1920)

1280

Crop Height (480-1280)

480

Watermark

Watermark Template

\$date\$ \$plateutf8\$ \$make\$ \$model\$ \$color\$ \$class\$

Watermark Position

Left-Top

Watermark Size

12px

- Select the required compression ratio for the saved images. The lower the number, the higher the compression ratio (and smaller the image size) but the quality of images will be lower. A setting of 80 is a good compromise.

- When a smaller image file size is needed you can use the 'Crop images' setting. This crops an area around the license plate to apply the compression to. This is better than over-compressing the whole image which will result in a very low-quality result!

When selected a dialog box opens allowing you to specify a width and height of the cropped image to be saved/transmitted.

In this case, a landscape image of 1280x480 will be saved:

Database plate details ⚙️ ✕

	Date	06/12/2022, 12:33:23
	Plate	YK16MLA
	Formatted	YK16MLA
	Country	GBR

<< < > >>

When still images are saved and/or transmitted to MOBOTIX SYNC/Helix or some other back office device using one of the other reporting options then the Watermark feature may be used to write for example the plate text and date onto the still image being sent.

The watermark template field allows you to insert dynamic text that will be overlaid onto the still image of the captured plate. Choose from the following list in the Annex [Dynamic Text Replacement Reserved Words](#).

You may then specify the font size to be used from a drop-down list and select one of four preset positions for the watermark to be overlaid.

In this example the Date, time in UTC format, plate details & MMC have been specified:



(See [Note on Timestamp Formats](#), p. 206.)

Advanced

Advanced

Advanced

Info

Check Vaxtor server for online updates

The Advanced dropdown causes the log file to be created with different levels of complexity to aid with identifying problems such as communication errors Etc.

Advanced

Advanced

Info

Trace

Debug

Info

You

should only use this feature when requested to do so by Support.

The second option is check the manufacturer's download server for online updates.

If this is selected and the camera has access to the internet, then each time the App is launched it will check online for the latest version and offer the option of downloading and updating.

Version 1.0.15 is available!

Do you want to update?

Changelog:

Add: reset.cgi command

Add: Online update option

Fix: Video tab UI scroll

Fix: Germany region recognition

Fix: Australia and Hungary grammar

Update: Improve false positives detection

No

Yes

The dialog box also displays the most recent changelog helping you make a more informed decision.

ALPR Settings: Save changes

IMPORTANT: To avoid unexpected problems, it is recommended that you backup the current configuration to your PC by downloading the configuration XML file (see [ALPR Settings, p. 138](#))

You can abandon your edits and reload the currently saved configuration file by clicking the Reload symbol, bottom right:

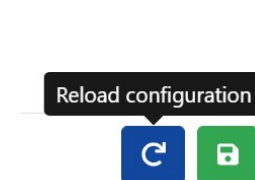

You must then save the current settings by clicking on the disk symbol, bottom right:

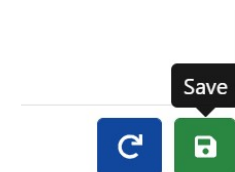

ALPR Plates

The most recent plate reads are stored in the camera's internal memory and are displayed when the Plates menu is selected:

Date	Plate	Image	Formatted	Country	Direction
10/08/2022, 17:53:55	VA13LWS		VA13LWS	GBR	Getting farther
10/08/2022, 17:53:28	AF22KFD		AF22KFD	GBR	Getting closer
10/08/2022, 17:53:26	BG59WME		BG59WME	GBR	Getting farther
10/08/2022, 17:53:20	FH09HWE		FH09HWE	GBR	Getting farther
10/08/2022, 17:53:03	AY13GFJ		AY13GFJ	GBR	Getting closer
10/08/2022, 17:53:01	WM70KTJ		WM70KTJ	GBR	Getting farther
10/08/2022, 17:52:51	AD68KKM		AD68KKM	GBR	Unknown
10/08/2022, 17:52:48	CU18HMJ		CU18HMJ	GBR	Getting closer
10/08/2022, 17:52:30	AJ66EYP		AJ66EYP	GBR	Unknown
10/08/2022, 17:52:25	AF15YHU		AF15YHU	GBR	Unknown
10/08/2022, 17:52:10	AD02OHP		AD02OHP	GBR	Unknown

More can be viewed as they will be stored in the browser's cache.

If the camera has a SD card installed, it is possible to store the LPR activity in a local database which can store up to 100,000 records (see [ALPR Database, p. 158](#)).



Click on a plate to view the plate read details:

Date	10/08/2022, 17:58:20
Plate	EX18UNB
Formatted	EX18UNB
Country	GBR
Direction	Unknown

Click the gear icon (top right) to reveal a list of fields that can be shown when a plate is selected:

Columns to show×

<input type="checkbox"/> ID	<input checked="" type="checkbox"/> Date
<input checked="" type="checkbox"/> Plate	<input checked="" type="checkbox"/> Image
<input type="checkbox"/> Formatted	<input checked="" type="checkbox"/> Country
<input type="checkbox"/> State	<input type="checkbox"/> Direction
<input type="checkbox"/> Category	<input type="checkbox"/> Speed
<input checked="" type="checkbox"/> Char height	<input type="checkbox"/> Confidence
<input checked="" type="checkbox"/> Make	<input checked="" type="checkbox"/> Model
<input checked="" type="checkbox"/> Color	<input checked="" type="checkbox"/> Class
<input checked="" type="checkbox"/> Multiplate rate	<input checked="" type="checkbox"/> Proc time
<input type="checkbox"/> ROI Id	<input type="checkbox"/> Blacklisted
<input type="checkbox"/> Whitelisted	<input type="checkbox"/> Signaled
<input type="checkbox"/> Signal Id	

NOTE! You can get a more comprehensive view of the vehicle from the Database option described in the next section. You will need to have an SD card fitted to use this feature.

(OCR) Processing Time

NOTE! If you do not have an SD card installed, you can look at the logfile to see the OCR processing time. When you view the OCR processing time you will see the multiplate rate alongside it. So if the multiplate rate is 5, for example, and the OCR processing time shows as 150ms, – then that means that ONE of the 5 reads (the one used to display the actual read being examined) took 150ms.

ALPR Database

- If the camera has a SD card installed, it is possible to store up to 100,000 plate reads in a local database. Once this limit is reached, new plate reads will replace the oldest ones. However, if the SD card becomes full before you set limit is reached then data will no longer be able to be saved.
- As a rough guide a 32GB SD card would store approximately 80,000 reads.

Database



The Database screen comprises:

1. Search and Load area
2. Settings
3. Play/Pause updating the database with new reads
4. Page display control
5. Total items stored and CSV download
6. Main plate list

Plate details

To show item details, click on a plate record.

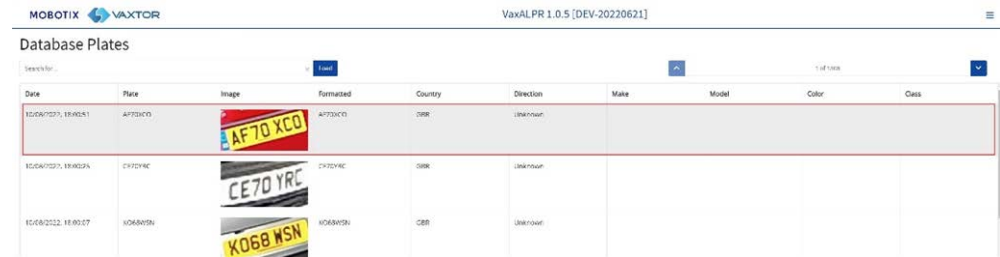

A new window appears with the vehicle details.

Database plate details ⚙️ ✕



Date	10/08/2022, 18:00:51
Plate	AF70XCO
Formatted	AF70XCO
Country	GBR
Direction	Unknown

<< < > >>

You can move up and down the complete database by using the arrows at the bottom of the plate record.



Use the double arrows to move to the first or last record in the database.

NOTE! If you have performed a Search (see below), then here you can step through all the plates that satisfy the search, e.g., all plates containing the numbers **123**.

Use the Settings Icon, top right, to control what information is displayed when you select a plate, i.e. a list of the available stored fields:

Database plate details



Fields to show ✕

<input type="checkbox"/> ID	<input checked="" type="checkbox"/> Date
<input checked="" type="checkbox"/> Plate	<input checked="" type="checkbox"/> Formatted
<input checked="" type="checkbox"/> Country	<input type="checkbox"/> State
<input checked="" type="checkbox"/> Direction	<input type="checkbox"/> Category
<input type="checkbox"/> Speed	<input type="checkbox"/> Char height
<input type="checkbox"/> Confidence	<input type="checkbox"/> Make
<input type="checkbox"/> Model	<input type="checkbox"/> Color
<input type="checkbox"/> Class	<input type="checkbox"/> Multiplate rate
<input type="checkbox"/> Proc time	<input type="checkbox"/> ROI Id
<input type="checkbox"/> Blacklisted	<input type="checkbox"/> Whitelisted
<input type="checkbox"/> Signaled	<input type="checkbox"/> Signal Id

↺ ↻ 🔒

NOTE! Some of these fields may not be available in your version of the software or are used for internal purposes such as communicating with certain third-party applications or Back Offices or VMS systems such as Genetec or MOBOTIX HUB.

When setting up a system the most useful to display include the Height (average character height), OCR (processing time), Confidence, Multiplate (how many reads were processed) etc.

Page Control

If there are more than 20 stored plate reads, the camera will paginate the results. Use the Page Control box to navigate through the pages.



Use the UP and DOWN buttons to scroll 20 plates at a time – or click on the central part of the button (in this case on 2/11) and enter the target page directly and click on GoTo:



Search and Load Plates

Load plates







1. To load all the detected plates stored in camera, keep the Search input zone empty and click the **Load** button. This will refresh the list with the latest captures.

Search for plates

To search for a specific plate or partial plate stored in camera, enter the plate in the Search box and click the **Search** button. Use the symbol % as a wildcard character.

Example of all plates containing the characters: '20':

Database Plates

Date	Plate	Image	Formatted	Country	Direction	Make	Model	Color	Class
11/06/2022 18:14:51	CV20 KZB		CV20KZB	GBR	Unknown				
11/06/2022 18:56:42	LM20 ANE		LM20ANE	GBR	Unknown				
11/06/2022 18:58:24	FL20 XLL		FL20XEL	GBR	Unknown				
11/06/2022 18:59:37	AK20 PBO		AK20PBO	GBR	Coming from...				
11/06/2022 17:49:13	AF20 YJJ		AF20YJJ	GBR	Coming from...				
11/06/2022 17:53:54	BT20 KKF		BT20KKF	GBR	Coming from...				
11/06/2022 17:17:19	EA20 UWM		EA20UWM	GBR	Coming from...				

To clear the search criteria, click  inside the Search window zone, and click the  button.



Download the Plate list

You can download the current Plate list by clicking on the CSV button:

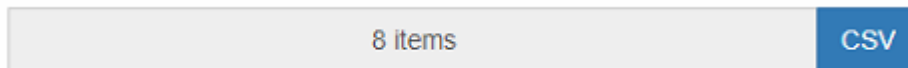

The resulting.csv file will be saved in your downloads folder.

NOTE! In this example only 8 items were in the search list which were then downloaded successfully. if you need to download the full database, then this must be downloaded page by page, 20 records at a time.

Do this by pausing the live reads  and then selecting each page in turn and downloading.

If you need to see all of the camera reads, then it is recommended that you send all the plate reads as they happen to a back office such as MOBOTIX SYNC/Helix. The program contains many reporting protocols and methods (see [ALPR Reporting, p. 170](#)).

ALPR Blacklists and Whitelists

The software can be configured to match any captured plates against a blacklist or whitelist or determine if a plate is not in a list. This will generate an event that can be captured and processed.

These lists are stored in the camera or on a network shared location:

1. If a camera SD card is installed, the lists will be stored on it depending on available space. Approximately up to 1 million plates can be stored.
2. If an SD card is not available, then the list will be stored in the camera's internal memory.

NOTE! The camera's internal memory is limited and so a maximum of 200 plates can be stored.



NOTE! The Lists can now be automatically synchronized with a central Helix Server. If you are running the MOBOTIX SYNC/Helix Back Office, you can choose to merge and then synchronize all of your blacklists and similarly your whitelists with any number of connected MOBOTIX MOVE cameras running ALPR. This enables you to perform real time checks or access control on the edge in case a network fails. Once reconnected the lists will synchronize once more. This can be setup in the Helix-6 menu in Reporting (see [Reporting to MOBOTIX SYNC/Helix, p. 170](#)).

ALPR Blacklist/Whitelist Disabled

Remember to enable black and/or whitelist checking in settings (see [Activate whitelists/blacklists, p. 142](#)):

- Enable database
- Enable whitelist

ALPR Blacklist: Initial load

When Blacklist is first selected, then if no plates have been added to the list, a message appears:

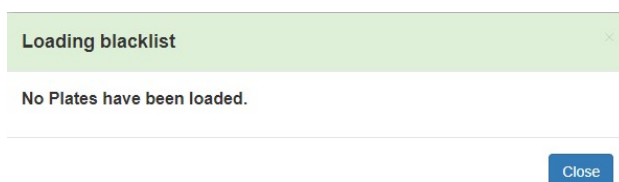

But if the Blacklist does already contain plates, a message appears confirming how many plates have been loaded into temporary memory.

ALPR Blacklist: Reload

Blacklist



To Reload the saved Blacklist from the camera, click the Reload Icon button and wait for the confirmation (or error) message.

ALPR Blacklist: Add a Plate



1. To add a Plate to the Blacklist, click the  button and enter the plate details:



Blacklist Detail ✕

Plate number

Description

Make Model

Color Classification

VALID FROM  VALID UNTIL 



2. Write a valid Plate (e.g. HA54ETR) and add an optional description. Plate numbers must not contain spaces or special characters such as “-“.
3. Enter the Valid From and Valid To dates that the vehicle will be checked. In the case of a whitelist, this would be the dates that the vehicle would be allowed access to a site (so the MOBOTIX MOVE relay will be triggered only within these two dates).

NOTE! The maximum Valid To date that can be set at present is 31/12/2030 (in the 2030s, there will be a millennium-type event where the number of seconds since Jan 1st 1970 will exceed a 16 bit value).

4. Add a Make, Model and Color if required.
5. Add a Vehicle Class from the drop-down menu (e.g., car).

NOTE! This may not be the same as the MMCV details that the program will generate from the shape of the vehicle.

6. Click the  icon to save the plate or close the window to discard the plate.

Edit a Plate

1. Click on a plate entry to re-edit a plate.
2. Edit any fields and click Save if required.

Remove a Plate from the list

Click the  to remove a plate and confirm the deletion.

ALPR Blacklist: Remove all plates

Click the  icon to remove all plates from the local Blacklist and confirm.

ALPR Blacklist: Upload/Download a list from a CSV file

Upload a CSV File

The ALPR software can import a whitelist/blacklist from a.csv file by using the  upload icon. Simply select the.csv file on your PC.

NOTE! The required header fields are CLASSIFICATION, COLOR, DESCRIPTION, FROM, ID, and TO. The first row of the csv file MUST contain field names including these headings.

For example:

classification;	COLOR;	DESCRIPTION;	FROM;	id;	MAKE;	MODEL;	plate_number;	TO
CAR;	red;	Fred Bloggs;	2022-07-31T23:00:00.000Z;	10;	Audi;	Q3;	VHY777;	2023-03-01T00:00:00.000Z
VAN;	blue;	Harry Oldham;	2022-07-31T23:00:00.000Z;	11;	Ford;	Kuga;	ABC123;	2022-08-30T23:00:00.000Z
CAR;	pink;	Fozzie Bear;	2022-01-01T23:00:00.000Z;	12;	VW;	Golf;	BCD234;	2022-12-31T23:00:00.000Z

NOTE! The file should contain semi colons as delimiters and not commas and the date delimiter should be a hyphen, US format).

Download a CSV file

1. To download the Blacklist file from the camera to your PC, click the  icon.
2. It will be downloaded to your PC's downloads folder as the file blacklist.csv.

ALPR: Whitelists

All the operations described above equally apply to whitelists.

ALPR Region of Interest

A Region of Interest (ROI), sometimes known as the Crop Zone, is used to define an area within the video frame where the OCR analytics takes place. The user can define a polygon and choose whether the area to look for plates in Inside or Outside this region. The user can then set multiple regions, i.e. multiple ROIs, in complex situations although this is rare.

Using an ROI can decrease OCR processing time and reduce false positives.

So if the camera is looking across a large stretch of road as in the example below, the ROI can be used to limit the OCR to the area near to the camera thus reducing the processor load.

If a plate-shaped house window or road sign for example is within the camera's field of view and keeps getting mistaken for a license plate, then these false positives can be eliminated by creating a crop zone to exclude this part of the image.

Each ROI must be given a unique numeric Identifier from the dropdown list.

NOTE! The entire license plate must be inside or outside of the ROI to pass the test.

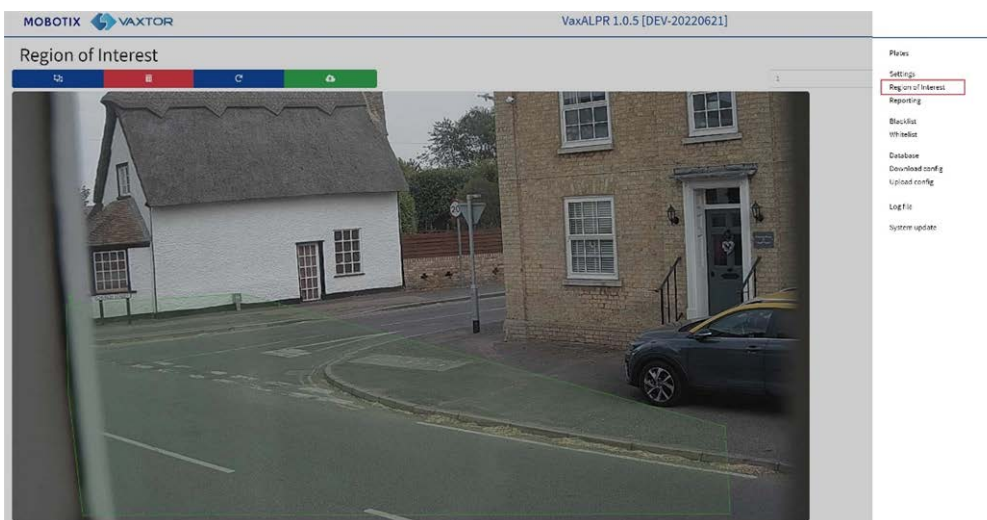

IMPORTANT: ROIs can be configured to either include the areas defined from the OCR – or exclude them. If multiple ROIs are added, they must all be of the same type.

ALPR ROI: Add ROIs

1. To add a new ROI, click the main  icon.
2. Then, use the pop-down to allocate an ID number to the ROI that you are adding and if this is the first ROI, then specify the ROI Type between: *Included* or *Excluded*.







3. Draw points:

1. **Add points:** Click on the live image to add new points to define the polygon.



NOTE! Each ROI must have at least 3 points but can also be quite complex.





2. To start again, click on the  icon.
3. To cancel the new ROI, click the  icon.
4. When you are satisfied with the shape click the  icon.
4. Click  to add more ROIs as required remembering to select a new ID number.
5. ROIs are not stored on the camera until changes are submitted by using the Submit ROIs  icon.

ALPR ROI: Remove ROIs

1. To remove one ROI, select the ROI number and click the  icon.
2. To remove all ROIs, click the  icon.

NOTE! This only deletes them in the local web interface. If they have been saved to the camera, you will need to submit ROIs once more.

ALPR ROI: Edit an ROI

1. To edit an existing ROI, select the ROI Id from the list and click the  icon.
2. **MOVE any points as required:**
 1. Add an extra point to last point added by moving the cursor and mouse click.
 2. Clear all existing points  and start again.
3. To confirm the changes, click the  button.
4. To reject any changes, click the  button.

ALPR ROI: Save changes

Once the ROIs have been set up, they must be saved into memory in the MOBOTIX MOVE camera.

To save all ROIs, click on the submit ROIs icon  and wait for the confirmation message.

NOTE! Once deleted, an ROI cannot be recovered. To avoid unexpected problems, it is recommended that you periodically backup the ROI configuration by downloading the current configuration XML file (see [ALPR Settings, p. 138](#)).

ALPR ROI: Reload ROIs

1. To reload ROIs from the camera into the web interface for editing, click the

 icon.

ALPR Reporting

ALPR can output all plate reads in real time using a variety of standard protocols so that the plate reads can be accepted remotely by a variety of programs including the powerful MOBOTIX SYNC/Helix Back Office, which can accept, and store plate reads in real time from hundreds of MOBOTIX MOVE cameras.

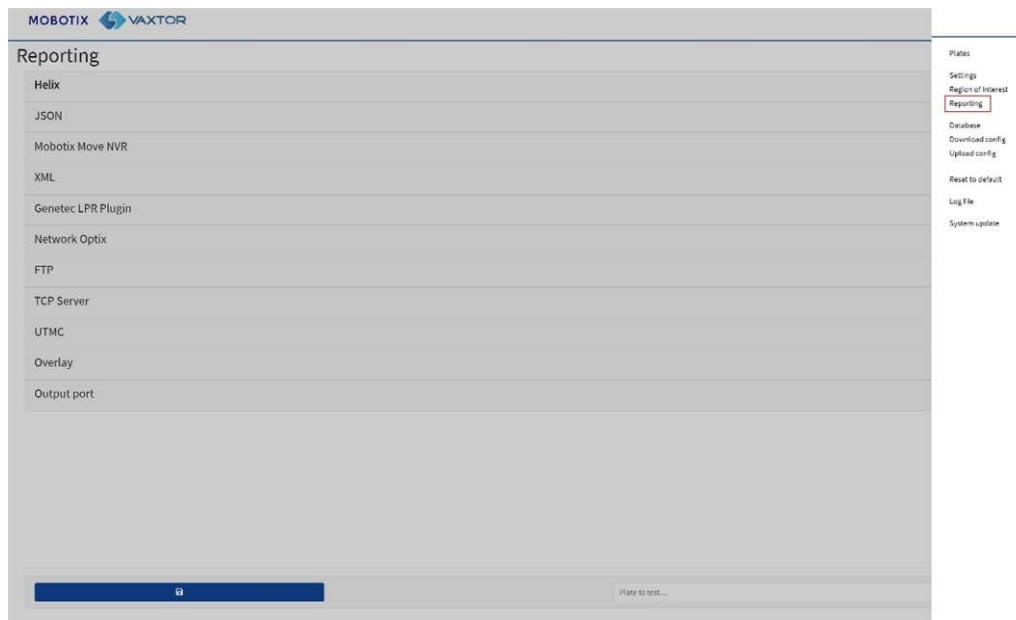

By selecting one of the listed protocols, a submenu will appear with fields for setting up parameters such as remote IP addresses etc.

Reporting

Helix
JSON
Mobotix Move NVR
XML
Genetec LPR Plugin
Network Optix
FTP
TCP Server
UTMC
Overlay
Output port

Reporting to MOBOTIX SYNC/Helix

To send encrypted reads to MOBOTIX SYNC/Helix, select MOBOTIX SYNC/Helix. This supports cameras in different time zones.

Helix

Active

Helix server URL

Apikey Camera Id

Reader Id Overview Id

Send Heartbeat

Heartbeat timer

Sync Lists

Select Active and enter the IP address (URL) of the receiving PC, e.g., 10.0.0.12:8080/helix6.

NOTE! This can be an http or an https address supporting data encryption.

Enter the Camera (or Reader ID – see MOBOTIX SYNC/Helix documentation) to be sent to MOBOTIX SYNC/Helix and an optional API key to be used for authentication. Overview ID is used if the camera is to be used as a color overview camera to be associated with another ALPR camera (not yet available).

Send Heartbeat

Select this and a time interval for the camera to send a heartbeat ping to MOBOTIX SYNC/Helix. MOBOTIX SYNC/Helix can be programmed to also upload an image from the camera at a pre-determined interval to monitor the image quality.

Sync Lists

Sync Lists

Sync lists timer

Lists can be automatically synchronized with a central MOBOTIX SYNC/Helix Server. If you are running the MOBOTIX SYNC/Helix Back Office you can choose to merge and then synchronize all of your blacklists and whitelists with any number of connected MOVE cameras running ALPR. This enables you to perform real time checks or access control on the edge in case a network fails. Once reconnected, the lists will synchronize once more.

- Select this option and then define a time interval for the lists to be re-synchronized.
- Click Submit reporting to store the configuration in the camera.

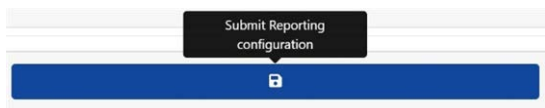

JSON (JavaScript Object Notation)

To activate this option:

1. Click on the XML header to expand the HTTP Post XML integration menu.
2. Enable the Active checkbox to enable JSON output and send HTTP/HTTPS POST messages in a JSON object.

JSON

Active

URL

Username Password

Send notifications without images

Message template

To setup this option, do the following:

1. Click on the Active button to expand the HTTP Post JSON integration menu.

2. Enter the receiving URL, such as:

`http://myserver.com/` or

`https://myserver.com:port/destination/mypage.php` (both domain names and IP addresses can be used).

IMPORTANT: If you are using a URL rather than an IP address, make sure that you have setup a DNS server in the main MOVE settings menu.

Go the main MOVE System menu and select Network & Basic. Select a DNS server such as: 8.8.8.8 with a secondary server of 8.8.4.4, for example. These are free Google DNS servers which will map your URL names.

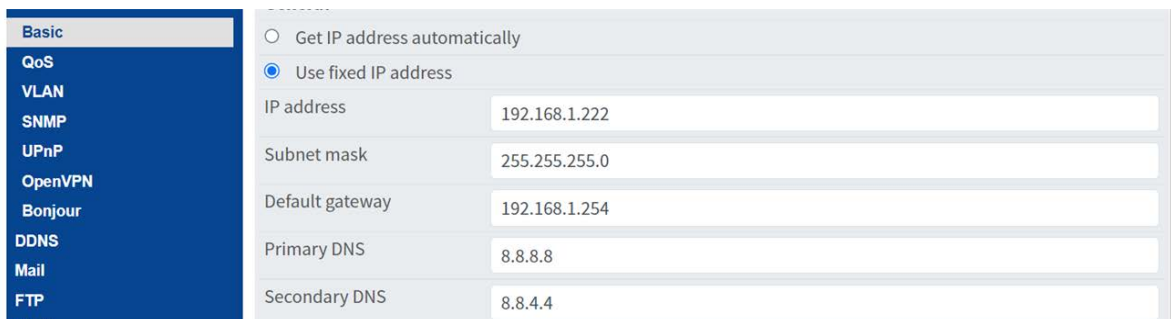

3. Set the receiving server's username and password.

4. Choose whether to send images or not.

5. Modify the message template as required. The message can use Dynamic text.

NOTE!

- You can use dynamic text replacement to match the current plate information:
A list is provided at the end of this manual: [Dynamic Text Replacement Reserved Words](#)
- There is also a separate document **Complete List of Dynamic Replacement Reserved Words** for the latest additions.

Examples:

- **\$image\$**: Full JPEG image encoded in base64.
- **\$jpegsize\$**: JPEG size in bytes.
- **\$date\$**: Timestamp in ISO8601 format
- **\$plate\$**: Plate number
- ...

You can add your own parameters into the message, so if you want to add a site ID, for example, your message might look like this:

```
{"plate":"$plate$", "date":"$date$", "ip":"$ip$", "country":"$country$", "sitecode": 12345}
```

6. Click Submit Reporting to store the configuration in the camera.



MOBOTIX MOVE NVR

This reporting option will cause ALPR to send each plate event to a MOBOTIX MOVE NVR device.

To activate this option:

1. Click on the MOBOTIX MOVE NVR header to expand the NVR integration menu.
2. **Enable the Active checkbox:**

A screenshot of a web-based configuration interface for 'Mobotix Move NVR'. At the top, there is a header 'Mobotix Move NVR' and a sub-header 'Active' with a checked checkbox. Below this, there are input fields for 'URL' (containing 'https://server'), 'Username', and 'Password'. A 'Message template' field contains XML code:

```
<?xml version="1.0" encoding="utf-8"?>
<AnalyticsEvent
  xmlns:si="http://www.w3.org/2001/XMLSchema-instance"
  xmlns="urn:milestone-systems">
```

3. Enter the target URL and port using this syntax

`http://<server_name_or_ip>:<port>/event_notify` (both domain names and IP addresses can be used).

For the example below ([Setting Up the MOBOTIX MOVE NVR, p. 176](#)), you would enter

`http://<server_name_or_ip>:51234/event_notify`.

NOTE! When using an HTTPS connection, enter `https://` as prefix instead of `http://` in the target URL.

4. Enter the username and password for accessing the MOVE NVR.
5. Modify the message as needed.

NOTE!

- You can use dynamic text replacement to match the current plate information: A list is provided at the end of this manual: [Dynamic Text Replacement Reserved Words](#)
- There is also a separate document **Complete List of Dynamic Replacement Reserved Words** for the latest additions.

Examples:

- **\$image\$**: Full JPEG image encoded in base64.
- **\$jpegsize\$**: JPEG size in bytes.
- **\$date\$**: Timestamp in ISO8601 format
- **\$plate\$**: Plate number
- ...

6. Scroll down and save your changes by clicking on the Submit Reporting icon.

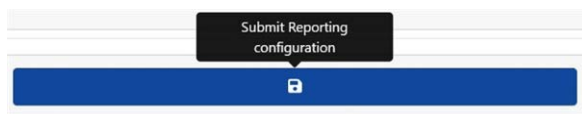

Setting Up the MOBOTIX MOVE NVR

Follow these steps to configure the MOBOTIX MOVE NVR device.

1. Open the MOBOTIX MOVE NVR user interface in your browser.
2. Open **Setup > Network > Event Receiver** and enable **Event Receiver**.

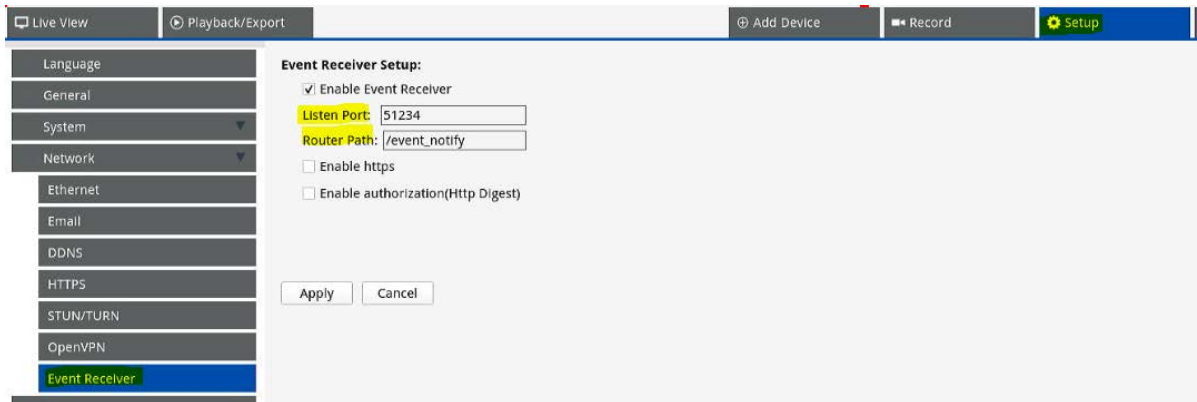

3. Enter the port you specified in Step 3 of [MOBOTIX MOVE NVR, p. 174](#).

NOTE!

- Make sure to use the same port and router path as in the camera (using the example above, the port would be 51234, the router path would be /event_notify).
- When using HTTPS in the camera, activate the **Enable https** checkbox.

4. In **Setup > System > Event Management**, add the camera to the MOVE NVR.

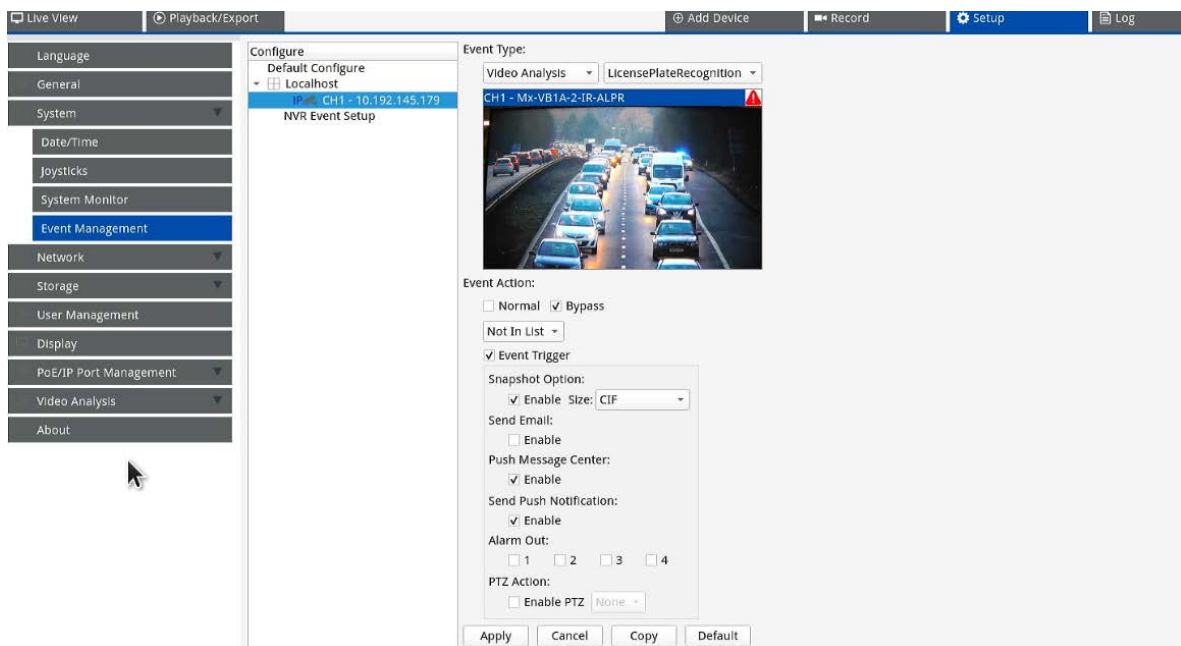

Next, set the following parameters on the same page:

- Select the *Video Analysis* and *License Plate Recognition* event types.
- Set **Event Action** to *Bypass* and select *Not in list* from the dropdown.
- Enable **Event Trigger** and activate the event triggers as needed.
- Click **Apply**.

Available Features on the MOBOTIX MOVE NVR

- Event notifications.

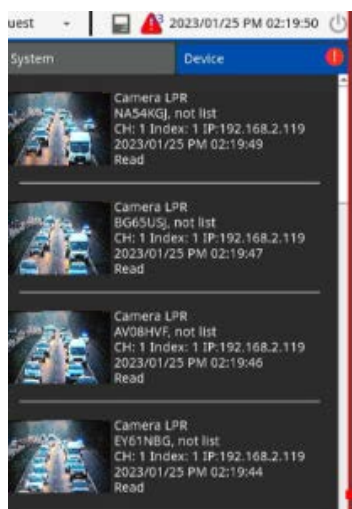

ALPR Best Practices

Configuring ALPR

- Detail information by double-clicking on an event.



- Information collected in the log.

The screenshot shows a software interface with a log table. The table has the following columns: No., Snapshot, Time, Channel Title, IP, Device Type, Description, Index, Value, List Mode, and Info. The table contains 17 rows of data, all representing 'License Plate Recognition' events. The 'Info' column contains truncated text, such as 'Great Britain,Towards,Fo...' and 'Great Britain,Towards,NL...'. On the left side, there is a sidebar with various filters and search options, including 'User Operation Log', 'IP Camera Event', and 'VA Detected Event'. The 'VA Type Filter' section is expanded, showing several checked options like 'Intrusion Detection', 'Loitering Detection', 'Camera Sabotage', etc. There are also search boxes for 'VA Event Search' and 'Advanced Search'.

No.	Snapshot	Time	Channel Title	IP	Device Type	Description	Index	Value	List Mode	Info
1		2023/01/25 PM 02:39:3	1	192.168.2.119	IPCAM	License Plate Recognition	1	BP63LVH	Not In List	Great Britain,Towards,Fo...
2		2023/01/25 PM 02:39:3	1	192.168.2.119	IPCAM	License Plate Recognition	1	EY09VWS	Not In List	Great Britain,Towards,NL...
3		2023/01/25 PM 02:39:2	1	192.168.2.119	IPCAM	License Plate Recognition	1	DA07CLX	Not In List	Great Britain,Towards,M... 6,Grey,
4		2023/01/25 PM 02:39:2	1	192.168.2.119	IPCAM	License Plate Recognition	1	L115Z2C	Not In List	Great Britain,Towards,To...
5		2023/01/25 PM 02:39:2	1	192.168.2.119	IPCAM	License Plate Recognition	1	GJ06EPD	Not In List	Great Britain,Towards,Ct...
6		2023/01/25 PM 02:39:2	1	192.168.2.119	IPCAM	License Plate Recognition	1	M110MU	Not In List	Great Britain,Unknown,C...
7		2023/01/25 PM 02:39:2	1	192.168.2.119	IPCAM	License Plate Recognition	1	KH06KSU	Not In List	Great Britain,Towards,...
8		2023/01/25 PM 02:39:1	1	192.168.2.119	IPCAM	License Plate Recognition	1	AF66jKV	Not In List	Great Britain,Towards,Fo...
9		2023/01/25 PM 02:39:1	1	192.168.2.119	IPCAM	License Plate Recognition	1	EF10DZT	Not In List	Great Britain,Towards,...
10		2023/01/25 PM 02:39:1	1	192.168.2.119	IPCAM	License Plate Recognition	1	AK64DMV	Not In List	Great Britain,Towards,...
11		2023/01/25 PM 02:39:1	1	192.168.2.119	IPCAM	License Plate Recognition	1	NA54K0J	Not In List	Great Britain,Towards,...
12		2023/01/25 PM 02:39:1	1	192.168.2.119	IPCAM	License Plate Recognition	1	BG65U5J	Not In List	Great Britain,Unknown,F...
13		2023/01/25 PM 02:39:1	1	192.168.2.119	IPCAM	License Plate Recognition	1	AV00HVF	Not In List	Great Britain,Towards,H...
14		2023/01/25 PM 02:39:0	1	192.168.2.119	IPCAM	License Plate Recognition	1	EY61N8G	Not In List	Great Britain,Towards,...
15		2023/01/25 PM 02:39:0	1	192.168.2.119	IPCAM	License Plate Recognition	1	FJ14ZHY	Not In List	Great Britain,Towards,Va...
16		2023/01/25 PM 02:39:0	1	192.168.2.119	IPCAM	License Plate Recognition	1	WR02FMD	Not In List	Great Britain,Towards,...
17		2023/01/25 PM 02:39:0	1	192.168.2.119	IPCAM	License Plate Recognition	1	KH05Z2K	Not In List	Great Britain,Towards,Va...

■ Charts in the **VA Event Search**.

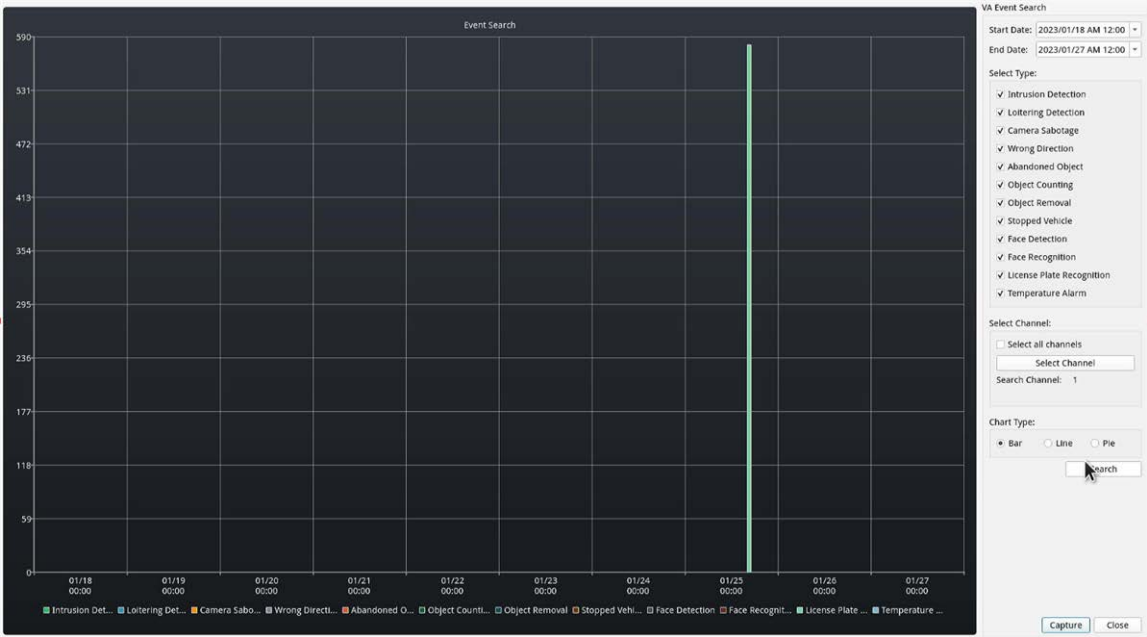

■ Advanced search features in the **Advanced Search**.

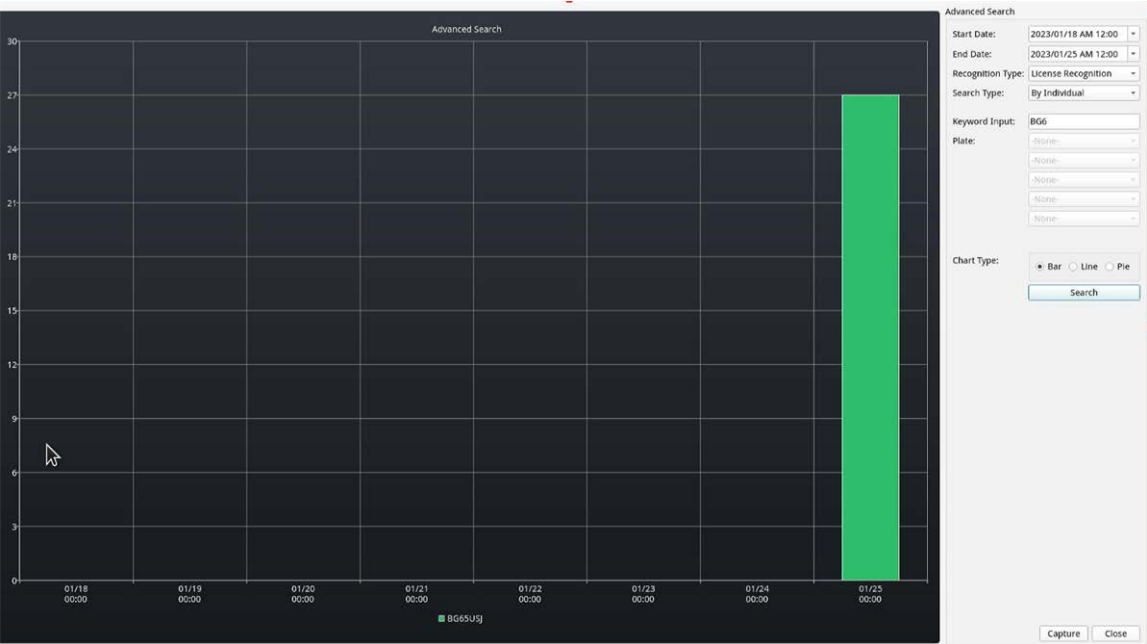

Sending HTTP/HTTPS POST XML Events

This reporting option will cause ALPR to send each plate event in an XML packet via an HTTP POST. This method can also be used to send events to MOBOTIX HUB.

To activate this option:

1. Click on the XML header to expand the HTTP Post XML integration menu.
2. **Enable the Active checkbox:**

3. Enter the target URL, such as:
`http://myserver.com/` or
`https://myserver.com:port/destination/mypage.php` (both domain names and IP addresses can be used).
For MOBOTIX HUB connections the URL should be: `http://milestoneserver:9090/`
 (both domain names and IP addresses can be used).
4. Enter a username and password as necessary.
5. Modify the message as needed. By default, the message is a valid Analytic Event for MOBOTIX HUB.

NOTE!

- You can use dynamic text replacement to match the current plate information:
 A list is provided at the end of this manual: [Dynamic Text Replacement Reserved Words](#)
- There is also a separate document **Complete List of Dynamic Replacement Reserved Words** for the latest additions.

Examples:

- **\$image\$:** Full JPEG image encoded in base64.
- **\$jpegsize\$:** JPEG size in bytes.
- **\$date\$:** Timestamp in ISO8601 format
- **\$plate\$:** Plate number
- ...

6. **Scroll down and save your changes by clicking on the Submit Reporting icon:**

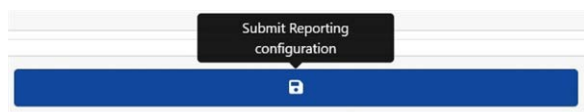

Connecting to MOBOTIX HUB

See the separate guide: [Connecting ALPR to MOBOTIX HUB](#).

Well-Formed XML

Below is an example of the default well-formed XML sent in an HTTP POST after the recognition of plate number M8016LS.

(A “well-formed XML document” is one which “adheres to the syntax rules specified by the [XML 1.0 Specification](#) in that it must satisfy both physical and logical structures.”)

NOTE! The bounding box information refers to the snapshot (image of the license plate patch encoded in Base64 format) sent in the message.

Example of well-formed XML sent in an HTTP POST

```
<?xml version="1.0" encoding="utf-8"?>
<AnalyticsEvent xmlns:i="http://www.w3.org/2001/XMLSchema-instance"
  xmlns="urn:milestone-systems">
  <EventHeader>
    <ID>00000000-0000-0000-0000-000000000000</ID>
    <Timestamp>2016-05-23T08:39:36.135998Z</Timestamp>
    <Type>License Plate Recognition</Type>
    <Message>VaxALPR On Camera Event</Message>
    <CustomTag>M8016LS</CustomTag>
    <Source>
      <Name>192.168.0.100</Name>
    </Source>
    <Description>M8016LS</Description>
    <ObjectList>
      <Object>
        <Name>Plate</Name>
        <Confidence>0.972857</Confidence>
        <Value>M8016LS</Value>
        <AlarmTrigger>true</AlarmTrigger>
        <Size>46</Size>
        <BoundingBox>
          <Top>0.42</Top>
          <Left>0.23</Left>
          <Bottom>0.54</Bottom>
          <Right>0.55</Right>
```

ALPR Best Practices

Configuring ALPR

```
</BoundingBox>
</Object>
</ObjectList>
<SnapshotList>
<Snapshot>
<TimeOffset>0</TimeOffset>
<Width>1280</Width>
<Height>960</Height>
<SizeInBytes>193656</SizeInBytes>
<Image>BASE64ENCODEDJPEG</Image>
</Snapshot>
</SnapshotList>
<Vendor>
<Name>Vaxtor Systems</Name>
</Vendor>
</AnalyticsEvent>
```

Configuring MOBOTIX HUB

Once the reporting option HTTP POST is configured, we need to set up MOBOTIX HUB to receive and handle our events. To do this, we recommend the following steps:

Step 1: Enable MOBOTIX HUB to receive ALPR events

In the MOBOTIX HUB Management Application click on the Options menu and then select the Settings option. This opens a new window.

Select the Analytic Events option and tick the Enabled checkbox. Save the changes using the OK button.

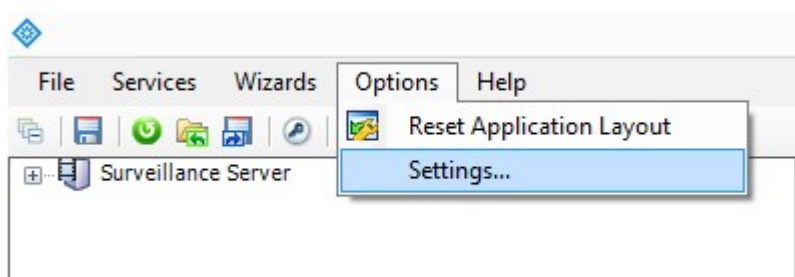

MOBOTIX HUB Management Application > Options menu > Settings option

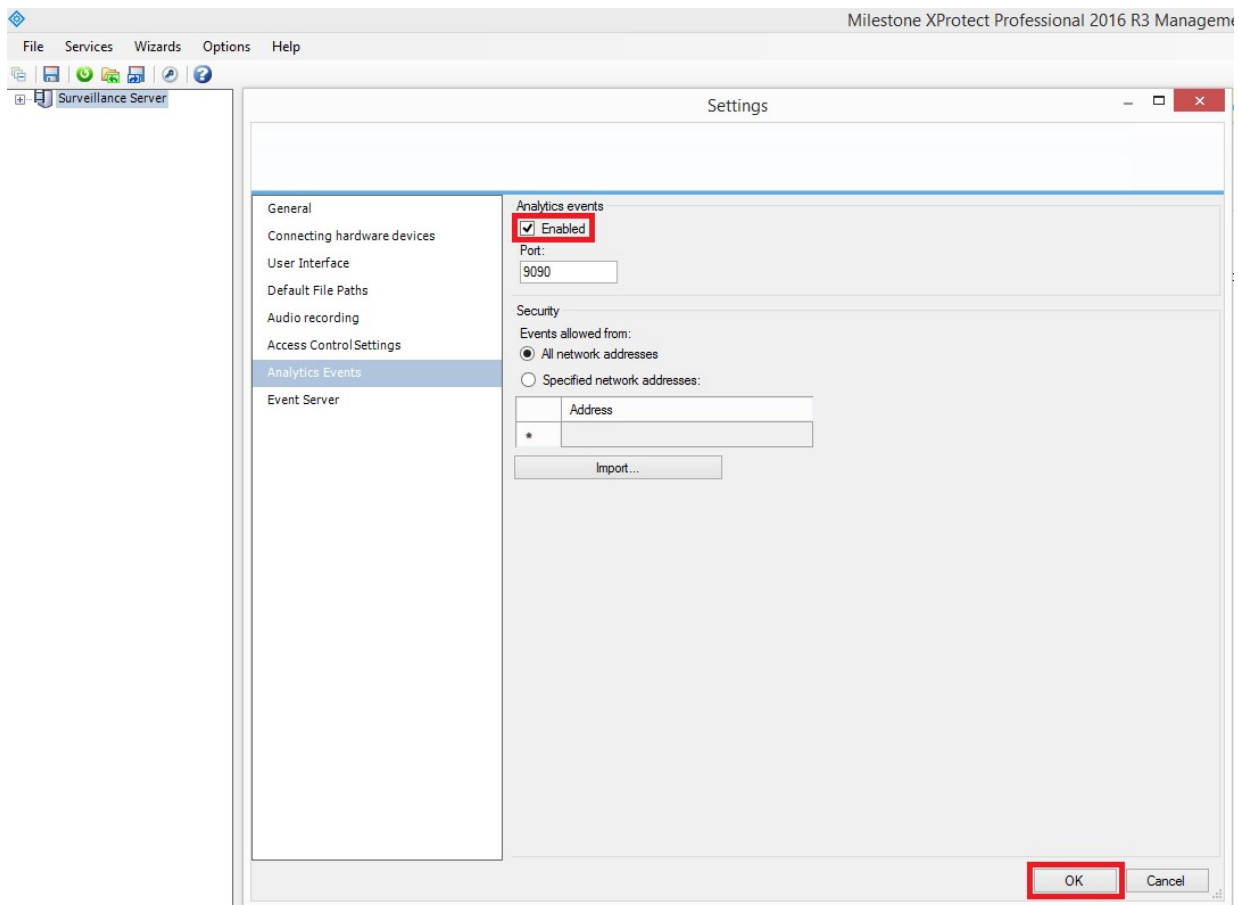

Fig. 5: MOBOTIX HUB Management Application > Options > Settings > Analytic Events: Enabled

Step 2: Create the ALPR Event in MOBOTIX HUB

Click on the Surveillance Server drop down menu and click on the 'Advanced Configuration' drop down menu and on the 'Events and Output' drop down menu. Click on the 'Analytics Events' option and right-click to access the Create New button. Click on the 'Create New' button to set up the event:

- Enter a Name for the Analytics Event (ALPR Event).
- Finally click on the OK button to save the changes.

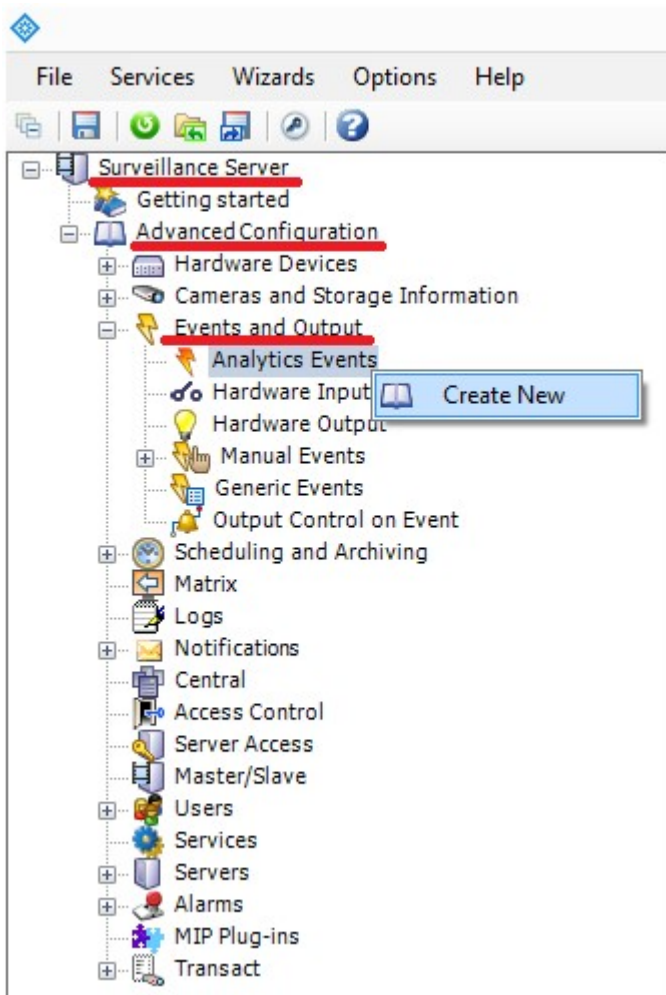

Fig. 6: Surveillance Server > Advanced Configuration > Events and Output >Analytic Events: Create New

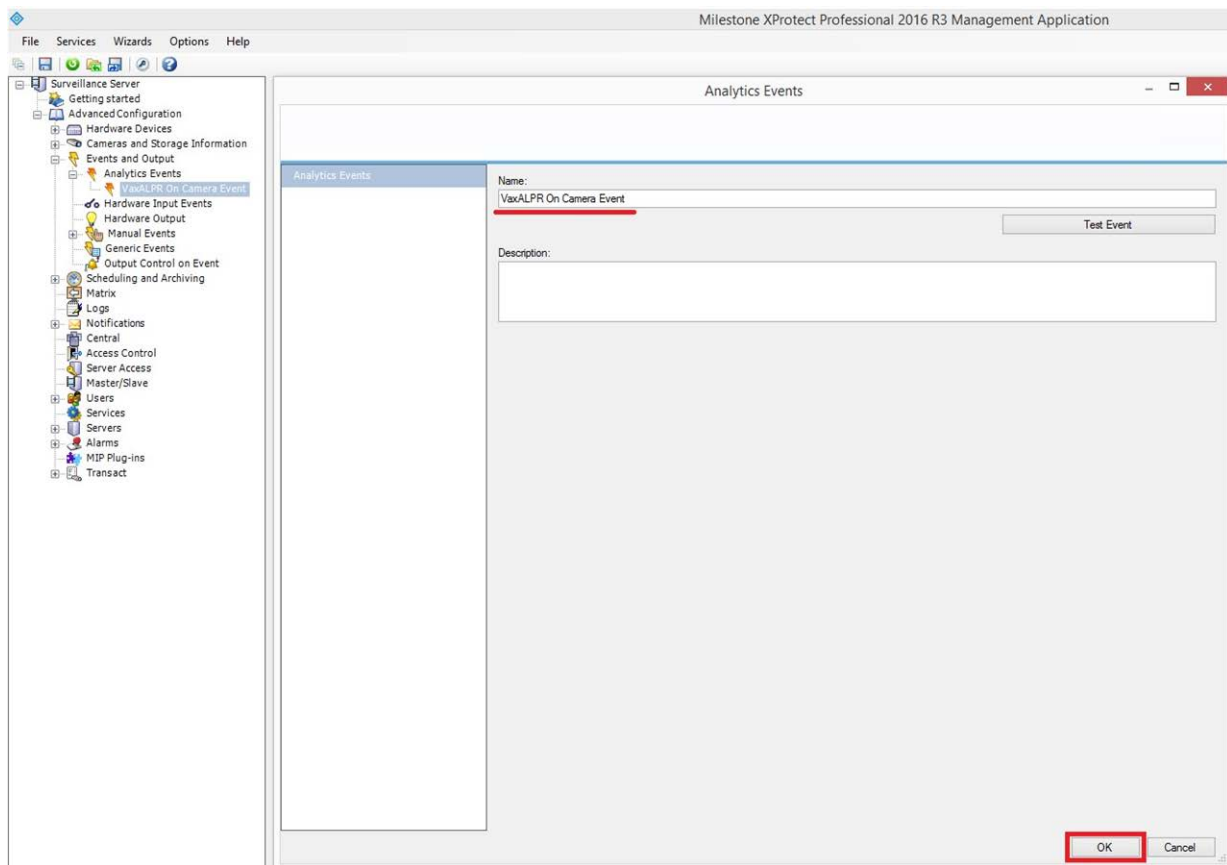

Fig. 7: Surveillance Server > Advanced Configuration > Events and Output >Analytic Events: ALPR Event

Step 3: Create the alarm that will trigger when MOBOTIX HUB receives the ALPR Event

Click on the Surveillance Server drop down menu and then select the 'Advanced Configuration' drop-down menu and then the 'Alarms' drop down menu.

Click on the 'Alarm Definitions' option and on right-click to access the 'Create New' button. Click on the Create New button to set up the alarm:

- Select the Enable checkbox to activate the alarm.
- Enter a Name of the alarm (Plate Detected).
- Select a Triggering event from the drop-down list. The Triggering event should be the Analytics Event. A second drop-down list will appear.
- Select the ALPR Event from the second drop-down list.
- Select a Source (the camera with the installed ALPR software).
- Finally click on the OK button to save the changes.

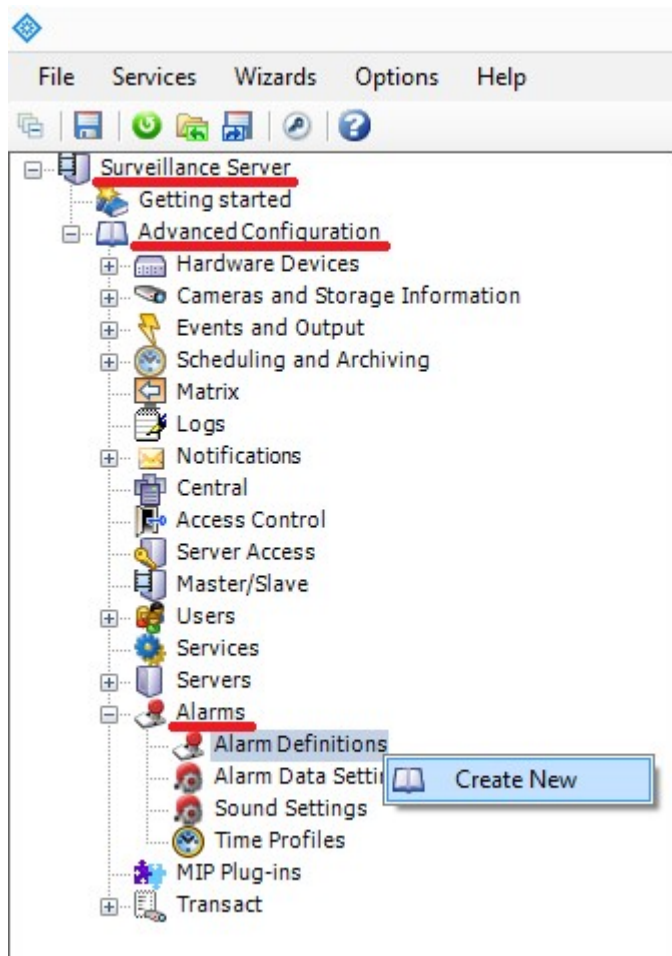

Fig. 8: Surveillance Server > Advanced Configuration > Alarms > Alarm Definitions option: Create New

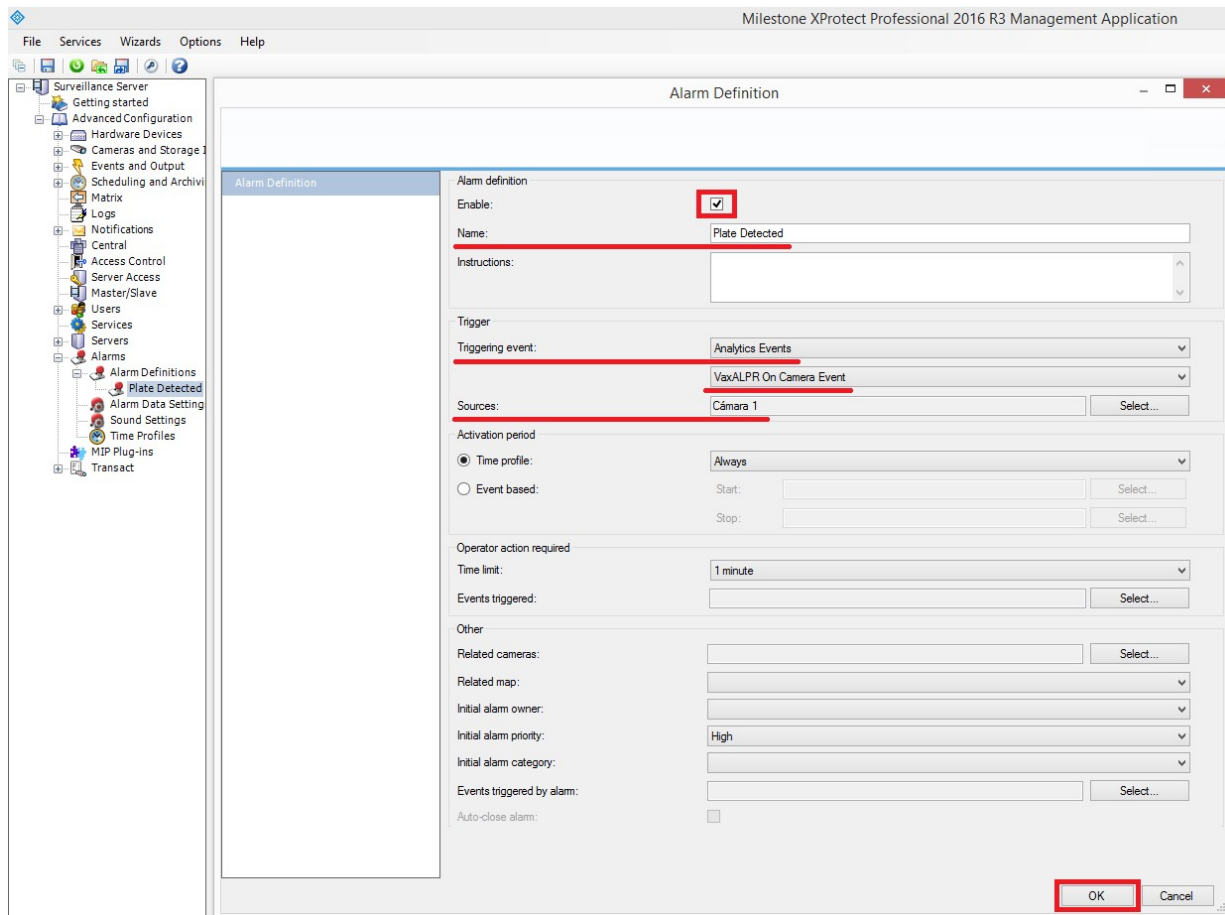

Fig. 9: Surveillance Server > Advanced Configuration > Alarms > Alarm Definitions: Plate Detected

Step 4: Modify the Alarm Data Settings

Click on the Surveillance Server drop down menu. Next click on the Advanced Configuration drop down menu and then on the Alarms drop-down menu.

Next, click on the Alarm Data Settings option and select the 'Alarm List Configuration' Tab and move the Object column from the Available columns to the Selected columns. This column will then indicate the plate number in MOBOTIX HUB.

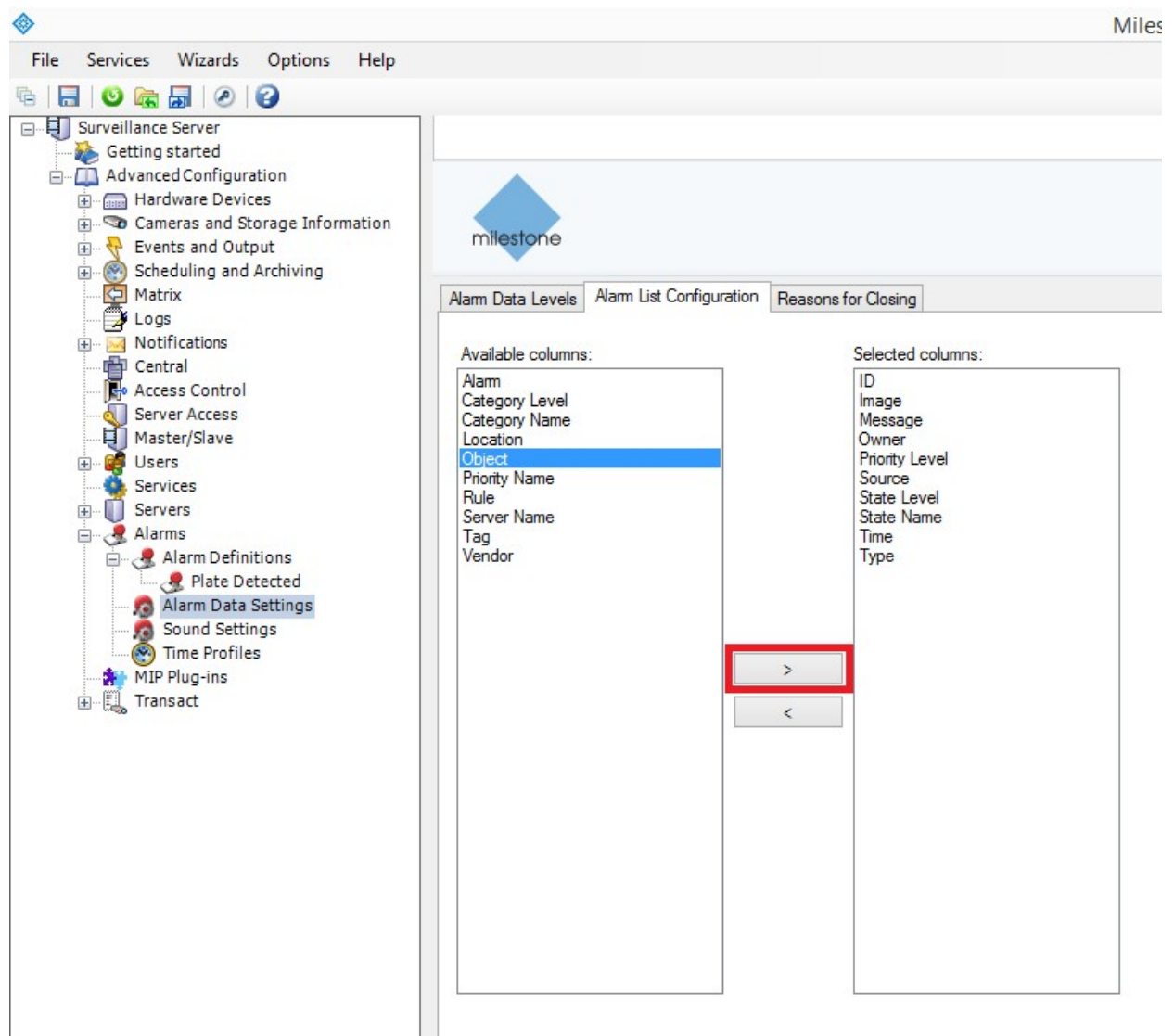

Fig. 10: Surveillance Server > Advanced Configuration > Alarms > Alarm Data Settings: Alarm List Configuration

Genetec LPR Plugin

This reporting option will cause ALPR to send each plate event to Genetec Security Centre as an ALPR event (not just a bookmark). The received reads can be used within Security Centre to generate alarms, open barriers, etc.

Contact Genetec for more information and to obtain a license for the Genetec software.

To activate this option:

1. Click on the XML header to expand the Genetec LPR Plugin integration menu.

2. Enable the Active checkbox:

Genetec LPR Plugin

Active

URL
https://server

Username
Username

Password
Password

Camera Id
camera_id

Camera Name
camera_name

Latitude
0

Longitude
0

3. Enter the target URL of the Genetec server, such as:

`http://myserver.com/` or

`https://myserver.com:port/destination/mypage.php` (both domain names and IP addresses can be used).

4. Complete all other fields as necessary and click the Submit Reporting icon:

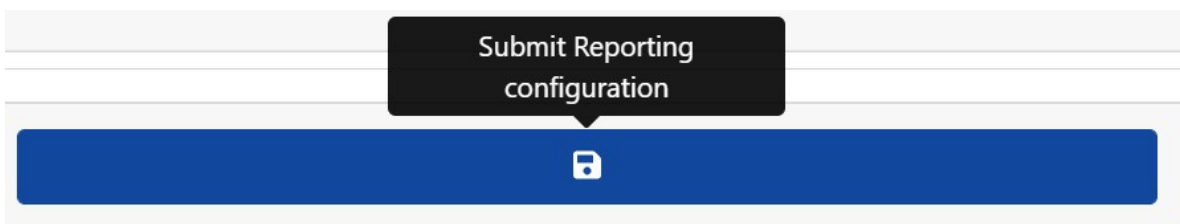

Network Optix Integration

This reporting options sends generic events and bookmark data to the Network Optix Nx Witness VMS system.

To setup this option, do the following:

1. In Reporting, click on the Network Optix option to expand the integration menu.

Network Optix

Active

URL
https://server

Camera Id
camera_id

Source
Source

Caption
Splate5

Description
Splate5 (Scountry5)

Username
user

Password

2. Enable the Active checkbox.

3. Enter the URL. The URL should be the address of the Nx host server using port 7001:

`http://nxserver:7001` e.g., `http://192.168.0.41:7001`

NOTE!

- The latest Optix Nx enforces https.
- Make sure that the IP address of the camera is on the same subnet.

4. Enter your Username & Password.
5. Enter a **Source** parameter. This is used by the Nx Server to reference the events received, e.g., **LPR**. This will mark all Nx events as **LPR** events.
6. Enter the Caption and Description templates. This data will be saved with each event.
7. Modify the two messages as required. The message can use Dynamic text replacement such as in the Overlay reporting option.

NOTE!

- You can use dynamic text replacement to match the current plate information:
A list is provided at the end of this manual: [Dynamic Text Replacement Reserved Words](#)
- There is also a separate document **Complete List of Dynamic Replacement Reserved Words** for the latest additions.

Examples:

- **\$image\$**: Full JPEG image encoded in base64.
- **\$jpegsize\$**: JPEG size in bytes.
- **\$date\$**: Timestamp in ISO8601 format
- **\$plate\$**: Plate number
- ...

You can add your own parameters into the message, so if you want to add a site ID, for example, your message might look like this:

```
{"plate":"$plate$", "date":"$date$", "ip":"$ip$", "country":"$country$", "sitecode": 12345}
```

8. Enter the Camera ID. This is the ID that has been setup in the Nx VMS settings. This can be found in Camera Settings.
9. When finished click on Submit Reporting icon.

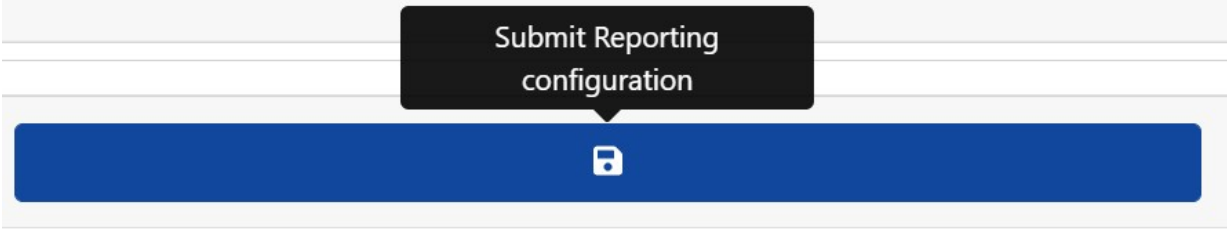

FTP Transmission

Choose this option to specify a remote site to receive data and images:

FTP

Active

URL
ftp://server

Username
user

Password

Filename
\$uuid\$. \$ftpfiletype\$

Template
\$date\$. \$plateutfis\$

Send Image

Send Patch

Send CSV file

Enter the address of the FTP server and any required username and password and then specify a filename which contains the image of the current plate.

The default filename template is: \$uuid\$. \$ftpfiletype\$ where:

- `$uuid$` is the unique identifier for each image and
- `$ftpfiletype$` is the image type. This word is important because it will add the words 'ocr', 'path' or 'overview' to the file names depending on the image type.

If this word is not included then all the images will be named identically, so only one will end up in the ftp storage.

You may also use other reserved words as appropriate in the Filename field to form the jpg filename with each file being an image of the vehicle.

Enter what csv data should be sent in the Template field by using dynamic text replacement separated by commas and select Send CSV file at the bottom of the dialog box.

Select which images are to be sent using the two tick boxes. Select from the main vehicle image and/or the plate patch image.

NOTE!

- You can use dynamic text replacement to match the current plate information: A list is provided at the end of this manual: [Dynamic Text Replacement Reserved Words](#)
- There is also a separate document **Complete List of Dynamic Replacement Reserved Words** for the latest additions.

Examples:

- **\$image\$**: Full JPEG image encoded in base64.
- **\$jpegsize\$**: JPEG size in bytes.
- **\$date\$**: Timestamp in ISO8601 format
- **\$plate\$**: Plate number
- ...

TCP Server

Choose this option to configure the MOVE camera as a TCP Server.

TCP Server

Active

Template: @\$plate\$#

Port (1024 - 65535): 3000

Once set up, multiple clients can connect to the configured port to receive data. The camera will send a configurable string data type to all connected clients.

The connection will remain open until it is closed by the camera if there is a configuration change.

Only the port and Message need to be set up. As before, you can modify the message as necessary using dynamic text replacement to match the current plate's information as in the previous example.

UTMC Integration

Choose this reporting option if you want ALPR to send plate reads using UTMC protocol. The Urban Traffic Management & Control program is a UK initiative for a more open method of communication in the ITS industry, especially in urban areas.

Plates can be sent in real time (individually) or in batches.

To activate this option, do the following:

1. Click on the UTMC protocol header to expand the UTMC setup menu as shown above.
2. Enable the Active checkbox.
3. Enter the URL of the receiving server.
4. Enter the Heartbeat and Diagnostics intervals to monitor the connection.
5. Enter a Camera ID (unique identifier for each camera).
6. All other fields are self-explanatory and define what data is transmitted to the UTMC BOF. Note that the default timeout is set to 5 seconds. If your server takes longer than this to respond, you should increase this value.
7. Click on the Submit reporting button to store the information in the camera.
8. Complete all other fields as necessary and click the Submit Reporting icon.

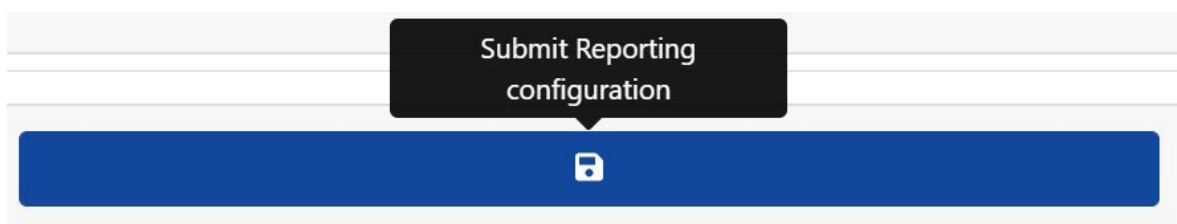

Overlay/Watermark

The Overlay function allows the user to specify some text that will be written as a watermark onto the camera's video stream which can be sent to VMSs (Video Management Systems) such as MOBOTIX HUB, Genetec or Network Optix, for example.

It can be used to watermark for example the time, date and last plate read as a video overlay.

To activate this option:

1. Click on the Overlay header to expand the menu.
2. Enable the Active checkbox:

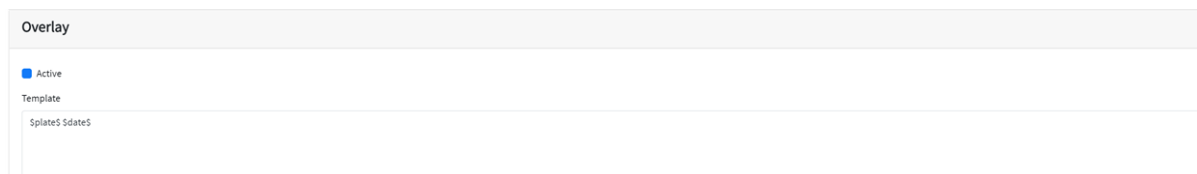

The screenshot shows a configuration window titled 'Overlay'. It has a section for 'Active' with a checked checkbox. Below it is a 'Template' field containing the text '\$plate\$ \$date\$'.

The watermark template field allows you to insert dynamic text that will be overlaid onto the still image of the captured plate.

NOTE!

- You can use dynamic text replacement to match the current plate information: A list is provided at the end of this manual: [Dynamic Text Replacement Reserved Words](#)
- There is also a separate document **Complete List of Dynamic Replacement Reserved Words** for the latest additions.

Examples:

- **\$image\$**: Full JPEG image encoded in base64.
- **\$jpegsize\$**: JPEG size in bytes.
- **\$date\$**: Timestamp in ISO8601 format
- **\$plate\$**: Plate number
- ...



In this example we are using some simple dynamic text with the date in ISO8601 format:

```
$plate$ $date$
```

This results in the last plate read appearing in the Live Video window:



Plates

Date	Plate	Image	Formatted	Country
16/08/2022, 16:29:57	EF68VTG		EF68VTG	GBR
16/08/2022, 16:29:39	PH11NHT		PH11NHT	GBR
16/08/2022, 16:29:35	PC02KER		PC02KER	GBR

Output Port

This option allows the user to trigger the camera's output port (relay) when certain events occur. This could be used for example to open a barrier or sound an alarm.

To activate this option:

1. Click on the Output Port header to expand the menu.
2. Enable the Active checkbox:

Output port

Active

Port

0

Trigger with all

Trigger with whitelist

Trigger with blacklist

Trigger with no list

The user can cause an event to be triggered Trigger any or all of the following conditions:

Trigger with all	Trigger the output port when a plate is read.
Trigger with whitelist	Trigger the output port when a plate is read & is in the whitelist.
Trigger with Blacklist	Trigger the output port when a plate is read & is in the blacklist.
Trigger without list	Trigger the output port when a plate is read and is not in any lists.

Select the output port to be triggered (see the MOBOTIX MOVE documentation for configuring and wiring the output port).

Save MOVE Reporting Settings

Once you have configured your reporting options then remember to save them by pressing **Submit Report Configuration** at the bottom of the screen.

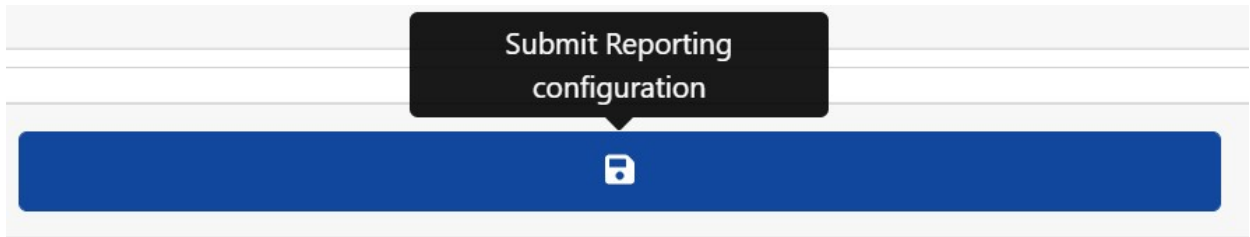

Testing Reporting

After configuring a notification, it is possible to simulate a read transmission. This feature can be used to confirm that the notification has been set up and is operating correctly.



To simulate a plate read notification:

1. Enter a plate number to test in the test window at the bottom of the screen, e.g., ABC123.
2. Click on the Test reporting icon: 

The plate will be sent to all enabled reporting end points.

You can check if the plates have been successfully sent by checking the log file (see [ALPR Show Logfile, p. 196](#)).

ALPR Show Logfile

This function displays the current System Log for debugging and testing purposes.

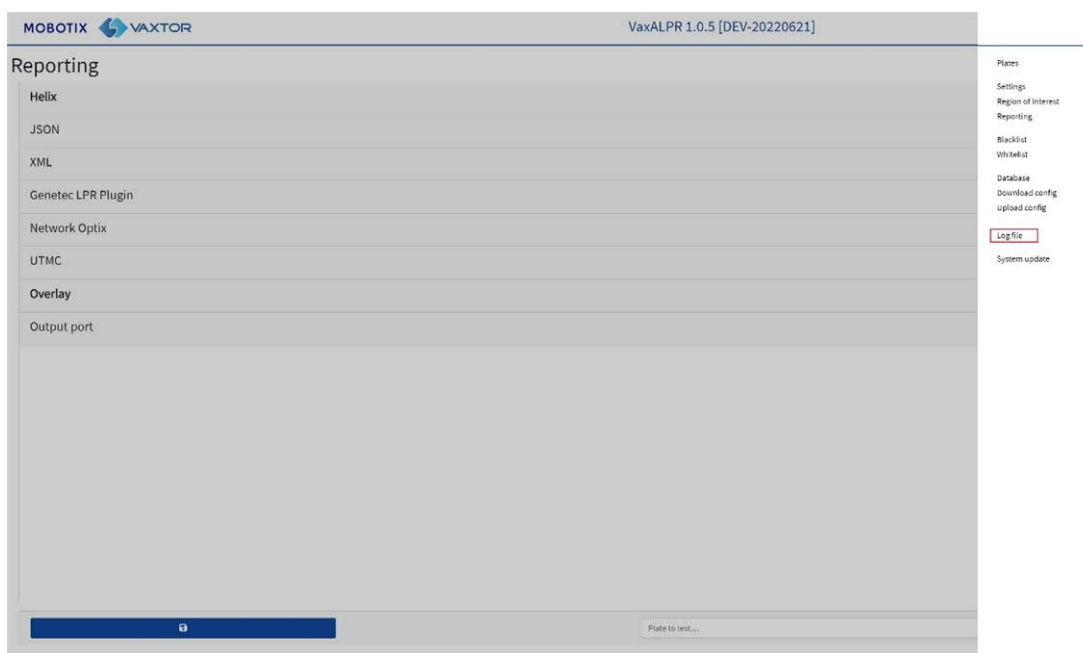

The application log appears as follows:

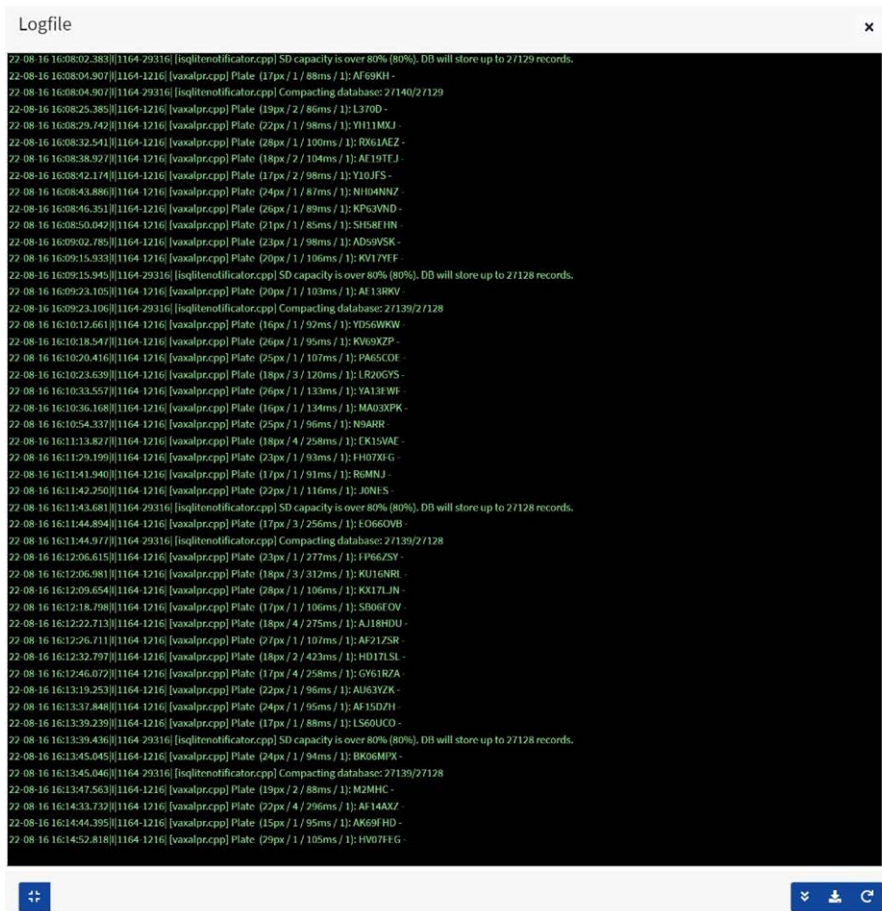

NOTE! The latest information is added to the bottom of the file so use the slider bar on the right to navigate up and down. Use the ‘Scroll to bottom’ icon  to move to the end of the file.

If new data is being recorded whilst you are browsing, then use the ‘Reload’ icon  to re-open the latest version of the file.

Error messages will appear here including if the program has failed to send data to a third-party application for some reason – or it has been rejected by a server.

Basic plate data includes the plate height, number of reads, time to process, etc.

The logfile can be downloaded to your PC by selecting the ‘Download Logfile’ icon .

Pressing the  icon allows you to reposition the logfile display in any one of four positions on your screen (to allow you to view settings around the window).



Selecting  reverts to the larger window, center screen.

Updating the ALPR System Software

Select System Update to update the ALPR App to the latest version.

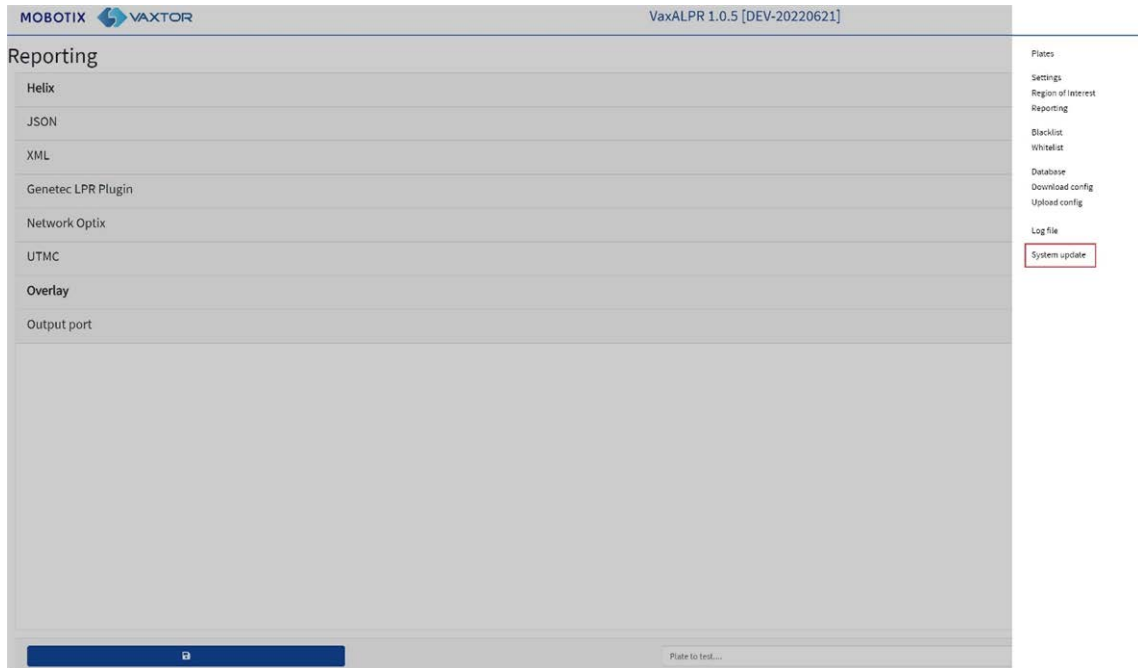

Select an update from your local PC if you have been sent one by the manufacturer.

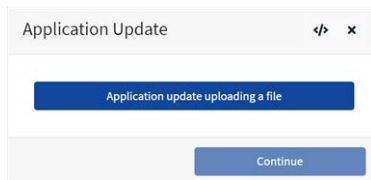

Select the application from your PC and click 'Open':

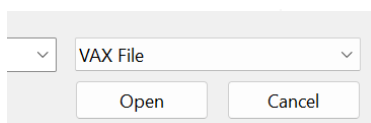

The new version will be loaded.

The  icon causes the logfile to be displayed.

Troubleshooting

Many license plate reading issues are caused due to:

- Incorrect positioning of the camera.
- Incorrect camera lens (or zoom setting).
- Insufficient illumination.
- Incorrect camera settings, e.g., shutter speed.
- Incorrect settings of the ALPR App.

In this section, we will study the most common issues and how to fix them.

ALPR software starts, but suddenly stops

1. **Solution:**
2. Check that you have uploaded the license key and check that the date and time of the MOBOTIX MOVE camera is set correctly.

ALPR license is valid, but a ‘Check license’ message appears

Solution:

Check that the date and time of the MOBOTIX MOVE camera is set correctly.

ALPR is running, but not reading plates

Solution:

Check if you can see the license plate in the image and that the image is of good quality, not under or over exposed. As a general rule, if you can't easily read the plates then the software won't be able to read them either!

Image is everything so first try to adjust the camera lens to zoom in or out. Failing that, check if the camera itself can be repositioned closer or further from the reading point. The captured image should show the complete vehicle. This however depends on the resolution that the camera has been set to.

If the video quality looks good then go to the camera's settings and ensure that the shutter speed is set high enough (for guidance on how to set shutter speeds, see [Setting the shutter speed and other important image settings, p. 117](#)).

If you CAN see the license plate clearly in the image and the software is not reading anything, try changing following parameters in the settings section of the App to be more tolerant:

1. In the Country options, do not select the Grammar Strict checkbox.
2. In the Video options, change the Minimum Character Height to 14 pixels.
3. In the Video options, change the Maximum Character Height to 60 pixels.
4. In the OCR options, change the Minimum Global Confidence to 50.
5. In the OCR options, change the Minimum Character Confidence to 25.
6. In the Region of Interest section, delete any existing Region of Interests (ROIs).

Once you can see the license plate image and the software is now reading, change these settings back one by one.

ALPR is running, but does not read some of the plates

Solution:

In the ALPR configuration, in the Video options, check the that value of the resolution in the drop-down list is adequate.

View the log file and scroll to the end and look for the message:

```
[INFO] Vaxreader[xxxx]: -Plate 0 (<pixel height> - <milliseconds>):  
<plate>
```

Then check the value of the plate's character pixel height registered in the log. If the resolution is 1280 x 960 and the pixel height of the plate is 40, It is recommended you set the resolution to a lower value.

Plate patches are inverted on the plates list

After installing a new MOBOTIX MOVE camera, sometimes the plate patches appear upside down after being read. Note that the camera has an auto-sensor to determine the orientation.

Solution:

1. **Set the correct orientation required in the MOBOTIX MOVE Camera Settings/Stream section:**

2. After changing this (or any other settings in the camera) you should stop start and restart In the ALPR Application – and all should be well.

JSON or XML have been set up, but plates are not received

Solution:

If you are using a remote URL to receive the data, check that a DNS server has been selected in the main MOBOTIX MOVE setup.

IMPORTANT: If you are using a URL rather than an IP address, make sure that you have setup a DNS server in the main MOVE settings menu.

Go the main MOVE System menu and select Network & Basic. Select a DNS server such as: 8 . 8 . 8 . 8 with a secondary server of 8 . 8 . 4 . 4, for example. These are free Google DNS servers which will map your URL names.

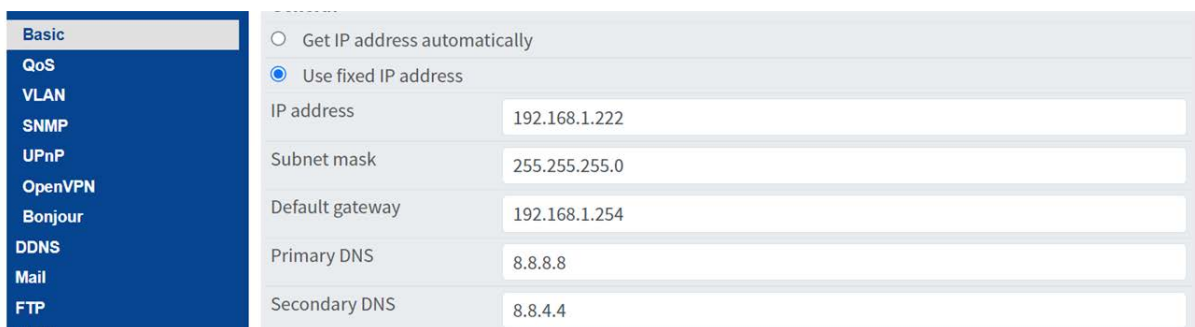

Basic	<input type="radio"/> Get IP address automatically
QoS	<input checked="" type="radio"/> Use fixed IP address
VLAN	IP address: 192.168.1.222
SNMP	Subnet mask: 255.255.255.0
UPnP	Default gateway: 192.168.1.254
OpenVPN	Primary DNS: 8.8.8.8
Bonjour	Secondary DNS: 8.8.4.4
DDNS	
Mail	
FTP	

Variables for Dynamic Text Replacement

This section includes the variables (reserved words) available to be used for DTR (Dynamic Text Replacement) within the ALPR applications on MOBOTIX MOVE cameras.

Plate Information

Variable	Description	Sample Result
\$plate\$	Plate number in ASCII	12AK385
\$plateutf8\$	Plate number in UTF-8	12AK385
\$tag\$	Hashed plate number. Same plate produces the same hash on repetitions.	9612548
\$formatted\$	Plate number formatted	12AK385
\$category\$	Plate number category	Private
\$country\$	Full country of origin name	United Arab Emirates
\$countrycode\$	ISO 3166 alpha-3 country code	ARE
\$countrycode2\$	ISO 3166 alpha-2 country code	AE
\$state\$	US State Name	Alaska
\$statecode\$	US State 2 digits code	AK
\$direction\$	Enumerate with the vehicle direction [0: Unknown 1: Towards 2: Away 3: Stopped]	
\$directionstr\$	String with the vehicle direction [unknown towards away stopped] towards	
\$charheight\$	Average character height in px	33
\$confidence\$	Global confidence obtained for the detected license plate [0 – 100]	99
\$confidenceprecision\$	Global confidence obtained for the detected license plate with 2 decimal places [0.00 - 100.00]	99.85

Variable	Description	Sample Result
\$multiplate\$	Amount of times that the plate has been read before reporting	4
\$processingtime\$	Processing time in ms	798
\$roiid\$	Region of interest (ROI) ID where the plate number is found	1
\$signaled\$	Indicates if the read was triggered (true or false)	true
\$signalid\$	Identificator provided on the trigger HTTP request	ab12cd34
\$uuid\$	Universally Unique Identifier (UUID) generated at the time of license plate detection	de5027d5-191d-4d3d-987b-dc104c-c27d5c

Analytics Information

Variable	Description	Sample Result
\$make\$	Vehicle make	Audi
\$model\$	Vehicle model	Q3
\$color\$	Vehicle color	White
\$class\$	Vehicle classification	Car

Date and Time Information

Variable	Description	Sample Result
\$date\$	ISO 8601 timestamp with UTC offset appended.	2023-09-19T23:47:01.65+02:00
\$datehour\$	Local timestamp in format YYYY-MM-DD HH:MM:SS.mmm	2023-09-19 23:47:01.065
\$timestamp\$	ISO 8601 local timestamp with UTC offset appended.	2023-09-19T23:47:01.65+02:00

ALPR Best Practices

Variables for Dynamic Text Replacement

Variable	Description	Sample Result
\$utcdate\$	ISO 8601 UTC timestamp.	2023-09-19T21:47:01.65Z
\$epoch\$	Unix epoch timestamp.	1695160021
\$day\$	Day in two digits. Single-digit days are displayed with a leading zero.	
\$month\$	Month in two digits. Single-digit months are displayed with a leading zero.	
\$year\$	Year in four digits.	2023
\$hour\$	Hour in two digits in 24-hour format. Single-digit hours are displayed with a leading zero.	
\$minute\$	Minutes in two digits. Single-digit minutes are displayed with a leading zero.	
\$second\$	Seconds in two digits. Single-digit seconds are displayed with a leading zero.	

Image Information

Variable	Description	Sample Result
\$absolutetop\$	Plate top position based on the total image height [0.00 - 1.00].	0.37
\$absoluteleft\$	Plate left position based on the total image width [0.00 - 1.00].	0.59
\$absolutebottom\$	Plate bottom position based on the total image height [0.00 - 1.00].	0.44
\$absoluteright\$	Plate right position based on the total image width [0.00 - 1.00].	0.66
\$top\$	Top coordinate for the plate on the image in px.	400
\$left\$	Left coordinate for the plate on the image in px.	1136
\$bottom\$	Bottom coordinate for the plate on the image in px.	477
\$right\$	Right coordinate for the plate on the image in px.	1269
\$width\$	Full image width in px.	1920

Variable	Description	Sample Result
\$height\$	Full image height in px.	1080
\$patchwidth\$	Plate patch image width in px.	134
\$patchheight\$	Plate patch image height in px.	78
\$image\$	Full image Base64-encoded.	
\$plateimage\$	Plate patch image Base64-encoded.	
\$imagesize\$	Full image size in bytes.	297249
\$plateimagesize\$	Plate patch image size in bytes.	3881

Lists and Conditionals Information

Variable	Description	Sample Result
\$blacklist\$	Description specified in the blacklist record.	Suspicious vehicle
\$whitelist\$	Description specified in the whitelist record.	Mr Smith car
\$iflist\$	Content enclosed in these variables will be appended when the detected plate is on a list. Example: <code>\$iflist\$ Content to append \$iflist\$</code>	
\$ifnolist\$	Content enclosed in these variables will be appended if the detected plate is NOT on any list (blacklist or whitelist).	
\$ifwhitelist\$	Content enclosed in these variables will be appended if the detected plate is on the whitelist.	
\$ifblacklist\$	Content enclosed in these variables will be appended if the detected plate is on the blacklist.	
\$ifnotwhitelist\$	Content enclosed in these variables will be appended if the detected plate is NOT on the whitelist.	
\$ifnotblacklist\$	Content enclosed in these variables will be appended if the detected plate is NOT on the blacklist.	

Camera Details and Other Information

Variable	Description	Sample Result
\$mac\$	Camera device MAC address.	00:11:22:ab:cd:ef
\$sensorid\$	Camera sensor ID where the plate is found.	0
\$stx\$	Start-of-text control character.	
\$etx\$	End-of-text control character.	

Note on Timestamp Formats

Timestamp format	Description
2023-09-19T23:47:01.65+02:00	ISO 8601 timestamp with UTC offset (e.g. +02:00) appended.
2023-09-19 23:47:01.065	Local timestamp in format YYYY-MM-DD HH:MM:SS.mmm
2023-09-19T23:47:01.65+02:00	ISO 8601 local timestamp with UTC offset appended.
2023-09-19T21:47:01.65Z	ISO 8601 UTC timestamp.

Technical Support Information

This section contains the following information:

Technical Specifications	208
---------------------------------------	------------

Technical Specifications

MOBOTIX EverClear Nano Coating

The new, groundbreaking MOBOTIX EverClear coating uses a special nano technology that transforms water droplets into an ultra-thin water film immediately upon impact. This ensures the highest image quality in rain and difficult environmental conditions and reduces maintenance costs due to its “self-cleaning” effect.



Product Information

Product Name	2MP Vandal Bullet ALPR Camera
Order Code	Mx-VB1A-2-IR(-D)-ALPR

Hardware Design

Processor	Ambarella CV22 (Quad-core ARM® Cortex®-A53, 1 GHz)
Memory	RAM: 512 MBytes FLASH: 256 MBytes
Image Sensor	2MP, 1/2.8" Progressive CMOS IMX462 (SONY STARVIS)
Effective (Used) Pixels	1920x1080 (2MP)

Lens

Minimum Illumination	Color: 0.02 lux B/W: 0.001 lux
Lens Characteristics	<p>Mx-VB1A-2-IR-ALPR:</p> <p>Motorized Lens: Zoom, Focus, P-IRIS</p> <p>Focal Length: 2.7 to 12 mm</p> <p>Aperture: F1.6 to F2.9</p> <p>Horizontal Field of View: 102.1° (Wide), 31.5° (Tele)</p> <p>Vertical Field of View: 70.3° (Wide), 22.7° (Tele)</p> <p>Mx-VB1A-2-IR-D-ALPR:</p> <p>Motorized Lens: Zoom, Focus</p> <p>Focal Length: 9 to 22 mm</p> <p>Aperture: F1.6 to F2.4</p> <p>Horizontal Field of View: 36.1° (Wide), 15.4° (Tele)</p> <p>Vertical Field of View: 19.8° (Wide), 8.8° (Tele)</p>
Front Glass Coating	<p>Superhydrophilic MOBOTIX EverClear nano coating transforms water droplets into an ultra-thin water film upon impact. The coating ensures best image quality in rain and difficult external conditions and it reduces reflections and noise in low-light scenarios. EverClear is dirt-repellent and increases the stability as well as the scratch-resistance of the front glass, further reducing maintenance efforts. Coating endurance up to 3 years depending on environmental conditions and cleaning treatment.</p>

Camera

Day/Night	Automatic mechanically switchable IR-cut filter
Shutter Speed	Up to 1/43040 s
Frame Rate (maximum)	H.265/H.264: 1920x1080@30 fps + 720x480@30fps MJPEG: 1080p@30fps
Auto Gain	Min. gain: 3 dB, max. gain: 48 dB, step size: 3
WDR	Up to 130 dB Multi Exposure WDR & HDR Engine support
Zoom	Optical zoom, digital zoom ready by lens type

Technical Support Information

Technical Specifications

Image settings	Color, Brightness, Sharpness, Contrast, White Balance, Exposure Control, 2DNR, 3DNR, NR by Motion, Masking, Text Overlay
Corridor Mode	90°, 180°, 270° Rotation

Video Codec

Compression/Encoding	H.265/H.264/MJPEG
Streaming	Up to 4 individually configurable streams in H.264/H.265/MJPEG; configurable resolution, frame rate, bandwidth LBR/VBR/CBR in H.265/H.264.

Audio Codec

Compression/Encoding	G.711/G.726/AAC/LPCM
Streaming	2-Way, bidirectional
Audio Input	Line In: Max 6.2 Vpp Signal In, Input Impedance: 33 k Ω
Audio Output	Line Out: 1 Vrms Signal Out, Output Resistance: 200 Ω

Cyber Security Features

Password Protection	Yes (including “forced” password change during initial setup)
IP address filtering	Yes (to restrict unauthorized access based on IP addresses)
IEEE 802.1X network access control	Yes (for advanced network security and authentication)
Digest authentication	Yes (for secure user authentication)
Secure Boot	Yes (support of fixed IP setting and automatic DHCP IP configuration according to individual MAC address)
AES encryption for password protection	Yes (to ensure strong encryption for password storage)
HTTPS/SSL (using TLS)	Yes (TLS 1.2 default, TLS 1.0/1.1 optional selectable)
User and Group Management	Yes (for fine-grained access control)

VPN	Yes (to establish secure network connections)
Digitally signed firmware	Yes (to prevent firmware file tampering)
RSA encryption	Yes (to support stronger ciphers; supported: RSA (2048 bits), AES-128, AES-256, SHA-256, SHA-384)

Network

Interface	10/100 Mbps Ethernet
Supported Protocols	ARP, PPPoE, IPv4/v6, ICMP, IGMP, QoS, TCP, UDP, DHCP, UPnP, SNMP, SMTP, RTP, RTSP, HTTP, HTTPS, FTP, NTP, DDNS, SMBv2
ONVIF conformance	Supports profiles S/G/T/M
Supported Browsers	All current browsers are supported.

ALPR (Automatic License Plate Recognition) Features

NOTE! Formatted 64 GB SD card is pre-installed! For replacement cards, using a 64 GB or larger SD card is recommended. See **MicroSD Cards for MOBOTIX MOVE Cameras** document on www.mobotix.com > Support > Download Center > Marketing & Documentation > White Lists.

Operational Range

- Monitors 1 or 2 lanes
- **Mx-VB1A-2-IR-ALPR:**
 - Reading distance up to 18 m/59 ft
 - Effective IR distance up to 20 m/66 ft
 - Recommended speed range from 0 to 60 km/h/37.3 mph
 - Suitable for low-speed scenarios: parking, Smart City traffic, etc.
- **Mx-VB1A-2-IR-D-ALPR:**
 - Reading distance up to 35 m/115 ft
 - Effective IR distance up to 35 m/115 ft
 - Recommended speed range from 0 to 160 km/h/99.4 mph (up to 200 km/h/124.3 mph)
 - Suitable for low-speed to high-speed scenarios: parking, Smart City traffic, urban traffic, highway traffic, etc.
- Min. to max. characters height: 14 to 70 pixels.
- Operates under extreme conditions such as low lighting, shadows, overexposed/damaged/dirty plates
- Operates in bad weather and with extreme angles while maintaining high-accuracy readings

MOBOTIX ALPR
MOBOTIX Machine/Deep
Learning Engine

- Full support of over a hundred countries (full list available upon request)
- High-performance DNN-based OCR engine for selected countries (full list available upon request)
- Support of Latin, Arabic, and Thai alphabets, GCC members, and enhanced North America state recognition
- Min. to max. characters height: 13 to 70 pixels (recommended 25 to 30)
- Max. rotation X (pitch) vertical angle $\pm 60^\circ$ (max $\pm 25^\circ$ for optimal performance)
- Max. rotation Y (yaw) horizontal angle $\pm 65^\circ$ (max $\pm 25^\circ$ for optimal performance)
- Max. rotation Z (roll) $\pm 35^\circ$ (max $\pm 10^\circ$ for optimal performance)
- Vehicle category, make, model, and color classification
- Direction of travel reporting/filtering
- Achieves >99% accuracy (several third-party independent assessments)

Results Integration

- Both push and pull modes supported (API available)
- Generic HTTP XML/2x JSON
- TCP/IP proprietary protocol (open)
- UTMC
- FTP
- TCP server
- Branded SW/VMS integration: MOBOTIX HUB, Genetec Security Center, Milestone XProtect, Axis Camera Station, Helix, Network Optix, among others.
- Branded HW integration: MOBOTIX MOVE NVRs.

Additional Features

- Failover capabilities for transmission of results
- Embedded whitelist/blacklist management
- Video overlay
- Customizable local relay triggering
- Free-flow or signaled modes
- 64 GB SD card pre-installed

System Integration

Base Video Analytics	<ul style="list-style-type: none">▪ Motion detection▪ Audio detection
Event Triggers	<ul style="list-style-type: none">▪ External input▪ Analytics▪ Network failure detection▪ Periodical event▪ Manual trigger▪ MxMessageSystem messages
Event Actions	<ul style="list-style-type: none">▪ External output activation▪ Video and audio recording to edge storage▪ File upload: FTP, network share and email▪ Notification: HTTP, FTP, email▪ MxMessageSystem messages

General

Housing Materials	Metal Back Housing, PC Front
Housing Color	RAL 9003
Device Color	PC front cover: RAL9003 Sunshield: <ul style="list-style-type: none">▪ Logo color: Pantone 286C and Pantone Gray 6 Cu▪ Body color: RAL9003▪ Back metal body: RAL9003
Power Requirements	PoE IEEE802.3af, class 0, max 12.95 W DC12V, max 15.59 W AC24V, max 13.31 W, max 25.08 VA
PoE Modes Supported	Mode A or Mode B

Connectors	RJ45, Alarm in x2, Alarm out x1, Audio in, Audio out terminal block, DC12V/AC24V terminal block, CVBS Connector COAX (75 Ohm) (CVBS output available with max. 2 activated streams)
IR Illumination	Visual up to 60 m/197 ft distance depending on scenery reflection
Video Storage	Micro SD/SDHC/SDXC card support up to 1 TB, Support for recording to NAS, MOBOTIX HUB, MOBOTIX MOVE NVR
SD Card pre-installed	64 GB
Environmental Protection Class	IP66/IP67 and IK10
Operating Temperature	-55 to 60 °C/-67 to 140 °F with heater
Cold Start Temperature	-30 °C/-22 °F
Relative Humidity	90 % non-condensing
Storage Conditions	-20 to 70 °C/-4 to 158 °F
Approvals	EMC: CE/FCC Safety: LVD Environmental: IP66/IP67, IK10
MTBF	95,000 hours
Warranty	5 years
Dimensions	ø 105x232 mm
Weight	1280 g

NOTE! Observe the [MOBOTIX MOVE Installation Hints](#) document to ensure optimum performance of the camera features.

Alarm Input/Output Current and Voltage

Alarm In	Alarm Out
3.3 V with 10 kΩ pull up, 50 mA	350 V DC/AC, 130 mA

MOBOTIX

BeyondHumanVision

EN_08/24

MOBOTIX AG • Kaiserstrasse • D-67722 Langmeil • Tel.: +49 6302 9816-103 • sales@mobotix.com • www.mobotix.com

MOBOTIX is a trademark of MOBOTIX AG registered in the European Union, the U.S.A., and in other countries. Subject to change without notice. MOBOTIX do not assume any liability for technical or editorial errors or omissions contained herein. All rights reserved. © MOBOTIX AG 2020