



Technical Specifications

MOBOTIX MOVE 4K (8MP) Vandal Fixed Dome Analytics Camera

The MOBOTIX MOVE 4K (8MP) Vandal Fixed Dome Analytics Camera extends the existing range of MOVE IP Camera series with a performant 4K (8MP) resolution camera with DNN (Deep Neural Network) video analytics features. The camera performs fast and reliable auto focus and adapts to different indoor and outdoor scenes. The integrated MOBOTIX MxMessageSystem allows direct communication and interaction with MOBOTIX IoT cameras via the IP network. The MOBOTIX EverClear superhydrophilic and self-cleaning nano coating of the dome ensures best image quality even in rain and reduces cleaning efforts and operational costs.

- EverClear coating of dome
- Motorized Vari-Focal Lens 3.6 to 11 mm, F1.5 to F2.0 with Zoom and One-Push Auto Focus
- Wide Dynamic Range (WDR) max. 130 dB
- MOBOTIX MxMessageSystem communication system
- Integrated Video Analytics (DNN ready)
- Integrated IR LEDs up to 40 m/131 ft Distance
- ONVIF Profile S/G/T/M support
- Triple power support (IEEE802.3af/AC24V/DC12V)
- Temperature Range -55 to 60 °C/-67 to 140 °F with heater
- IP66 and IK10
- Quick Connection Mount



BeyondHumanVision

MOBOTIX MOVE

Technical Specifications

MOBOTIX MOVE 4K (8MP) Vandal Fixed Dome Analytics Camera

High-Quality DNN Edge Video Analytics



The latest computer vision technology makes the DNN-accelerated video processing engine efficient at the edge. This integrated engine provides high accuracy, and 10 (DNN-based) video analytics functions including ALPR and human face recognition. Moreover, it allows simultaneous detection on multiple objects.

MOBOTIX EverClear Nano Coating

The new, groundbreaking MOBOTIX EverClear coating uses a special nano technology that transforms water droplets into an ultra-thin water film immediately upon impact. This ensures the highest image quality in rain and difficult environmental conditions and reduces maintenance costs due to its “self-cleaning” effect.



Product Information

Product Name	4K (8MP) Vandal Fixed Dome Analytics Camera
Order Code	Mx-VD1A-8-IR-VA

Hardware Design

Processor	Ambarella CV22 (Quad-core ARM® Cortex®-A53, 1 GHz)
Memory	RAM: 512 MBytes FLASH: 256 MBytes

Technical Specifications

MOBOTIX MOVE 4K (8MP) Vandal Fixed Dome Analytics Camera

Image Sensor	4K (8MP), 1/1.8" Progressive CMOS IMX334 (SONY STARVIS)
Effective (Used) Pixels	3864x2180 (4K/8MP)

Lens

Minimum Illumination	Color: 0.04 lux B/W: 0.002 lux
Lens Characteristics	Motorized Lens: Zoom, Focus, P-IRIS Focal Length: 3.6 to 11 mm Aperture: F1.5 to F2.0 Horizontal Field of View: 115.0° (Wide), 47.5° (Tele) Vertical Field of View: 61.2° (Wide), 27.0° (Tele)
Lens Mechanics	3-Axis adjustment
Dome Coating	Superhydrophilic MOBOTIX EverClear nano coating transforms water droplets into an ultra-thin water film upon impact. The coating ensures best image quality in rain and difficult external conditions and it reduces reflections and noise in low-light scenarios. EverClear is dirt-repellent and increases the stability as well as the scratch-resistance of the dome, further reducing maintenance efforts. Coating endurance up to 3 years depending on environmental conditions and cleaning treatment.

Camera

Day/Night	Automatic mechanically switchable IR-cut filter
Shutter Speed	Manual Mode: WDR: up to 1/67500 s Linear: up to 1/13500 s Automatic Mode: Up to 1/10000 s
Frame Rate (maximum)	H.265/H.264: 3864x2180@30 fps + 1920x1080@30 fps MJPEG: 1080p@30 fps
Auto Gain	Min. gain: 3 dB, max. gain: 48 dB, step size: 3

Technical Specifications

MOBOTIX MOVE 4K (8MP) Vandal Fixed Dome Analytics Camera

WDR	Up to 130 dB Multi Exposure WDR & HDR Engine support
EIS (Electronic Image Stabilizer)	No
Zoom	Optical: 3.1x, Digital: 10x
Image settings	Color, Brightness, Sharpness, Contrast, White Balance, Exposure Control, 2DNR, 3DNR, NR by Motion, Masking, Text Overlay
Corridor Mode	90°, 180°, 270° Rotation

Video Codec

Compression/Encoding	H.265/H.264/MJPEG
Streaming	Up to 4 individually configurable streams in H.264/H.265/MJPEG; configurable resolution, frame rate, bandwidth LBR/VBR/CBR in H.265/H.264.

Audio Codec

Compression/Encoding	G.711/G.726/AAC/LPCM
Streaming	2-Way, bidirectional
Audio Input	Line In: Max 6.2 Vpp Signal In, Input Impedance: 33 k Ω
Audio Output	Line Out: 1 Vrms Signal Out, Output Resistance: 200 Ω

Cyber Security Features

Password Protection	Yes (including “forced” password change during initial setup)
IP address filtering	Yes (to restrict unauthorized access based on IP addresses)
IEEE 802.1X network access control	Yes (for advanced network security and authentication)
Digest authentication	Yes (for secure user authentication)
Secure Boot	Yes (support of fixed IP setting and automatic DHCP IP configuration according to individual MAC address)
AES encryption for password protection	Yes (to ensure strong encryption for password storage)

Technical Specifications

MOBOTIX MOVE 4K (8MP) Vandal Fixed Dome Analytics Camera

HTTPS/SSL (using TLS)	Yes (TLS 1.2 default, TLS 1.0/1.1 optional selectable)
User and Group Management	Yes (for fine-grained access control)
VPN	Yes (to establish secure network connections)
Digitally signed firmware	Yes (to prevent firmware file tampering)
RSA encryption	Yes (to support stronger ciphers; supported: RSA (2048 bits), AES-128, AES-256, SHA-256, SHA-384)

Network

Interface	10/100 Mbps Ethernet
Supported Protocols	ARP, PPPoE, IPv4/v6, ICMP, IGMP, QoS, TCP, UDP, DHCP, UPnP, SNMP, SMTP, RTP, RTSP, HTTP, HTTPS, FTP, NTP, DDNS, SMBv2
ONVIF conformance	Supports profiles S/G/T/M
Supported Browsers	All current browsers are supported.

System Integration

Base Video Analytics	<ul style="list-style-type: none">▪ Motion detection▪ Audio detection
Enhanced Video Analytics	<ul style="list-style-type: none">▪ Abandoned objects▪ Intrusion (object classification)▪ Sabotage▪ Wrong direction▪ Loitering (object classification)▪ Object counting (object classification)▪ Object removal▪ Stopped vehicle (object classification) <p>2 analytics functions can be activated simultaneously</p>

Technical Specifications

MOBOTIX MOVE 4K (8MP) Vandal Fixed Dome Analytics Camera

DNN (Deep Neural Network)
based video analytics

- Face Recognition (incl. gender & age estimation)
- Number Plate Recognition – supported countries:
Armenia, Austria, Azerbaijan, Belarus, Belgium, Bosnia and Herzegovina, Bulgaria, Croatia, Cyprus, Czech Republic, Denmark, Estonia, Finland, France, Georgia, Germany, Greece, Hungary, Ireland, Israel, Italy, Japan, Kazakhstan, Kyrgyzstan, Latvia, Lithuania, Luxembourg, Moldova, Monaco, Montenegro, Netherlands, North Macedonia, Norway, Poland, Portugal, Romania, Russia, Serbia, Slovakia, Slovenia, Spain, Sweden, Switzerland, Taiwan, Turkey, Ukraine, United Kingdom, Uzbekistan, Vietnam

Event Triggers

- External input
- Analytics
- Network failure detection
- Periodical event
- Manual trigger
- MxMessageSystem messages

Event Actions

- External output activation
- Video and audio recording to edge storage
- File upload: FTP, network share and email
- Notification: HTTP, FTP, email
- MxMessageSystem messages

General

Housing Materials

Metal Housing

Housing Color

RAL 9003

Camera Module Adjustment

3-Axis Gimbal (Pan/Tilt/Rotate)

Device Color

Metal body housing: RAL 9003

Logo color: Pantone 286C and Pantone Gray 6 Cu

MOBOTIX MOVE 4K (8MP) Vandal Fixed Dome Analytics Camera

Power Requirements	PoE IEEE802.3af, class 0, max 11.67 W DC12V, max 12.14 W AC24V, max 11.99 W, max 20.02 VA Zero-Down-Time Power Source Switching
PoE Modes Supported	Mode A or Mode B
Connectors	RJ45, Alarm in x2, Alarm out x1, Audio in, Audio out terminal block, DC12V/AC24V terminal block, CVBS Connector COAX (75 Ohm) (CVBS output available with max. 2 activated streams, requires optional adapter 2-pin COAX cable)
IR Illumination	Up to 40 m/131 ft distance depending on scenery reflection
Video Storage	Micro SD/SDHC/SDXC card support up to 1 TB, Support for recording to NAS, MOBOTIX HUB, MOBOTIX MOVE NVR
Environmental Protection Class	IP66 and IK10
Operating Temperature	-55 to 60 °C/-67 to 140 °F with heater
Cold Start Temperature	-30 °C/-22 °F
Relative Humidity	90 % non-condensing
Storage Conditions	-20 to 70 °C/-4 to 158 °F
Approvals	EMC: CE/FCC Safety: LVD Environmental: IP66, IK10
MTBF	95,000 hours
Warranty	5 years
Dimensions	ø 133.8 x 117.4 mm
Weight	760 g

NOTE! Observe the [MOBOTIX MOVE Installation Hints](#) document to ensure optimum performance of the camera features.

Technical Specifications

MOBOTIX MOVE 4K (8MP) Vandal Fixed Dome Analytics Camera

Alarm Input/Output Current and Voltage

Alarm In

3.3 V with 10 k Ω pull up, 50 mA

Alarm Out

350 V DC/AC, 130 mA







DORI Specifications

In the video surveillance context, “DORI” stands for Detection, Observation, Recognition and Identification and is based on IEC EN62676-4: 2015. These levels define the minimum pixels that a face of a person must have to provide proper identification, for example.

- **Detection:** Up to this distance, you can reliably determine if a person or vehicle is present.
- **Observation:** Up to this distance, you can see characteristic details of an individual, such as distinctive clothing.
- **Recognition:** Up to this distance, you can determine with a high degree of certainty whether an individual is the same as someone that has been seen before.
- **Identification:** Up to this distance, you can determine the identity of an individual beyond reasonable doubt.

DORI Level	Detection		Observation		Recognition		Identification	
	Wide	Tele	Wide	Tele	Wide	Tele	Wide	Tele
Mx-VD1A-8-IR-VA	77 m/ 253 ft	183 m/ 600 ft	30 m/ 98 ft	73 m/ 240 ft	15 m/ 49 ft	37 m/ 121 ft	8 m/ 26 ft	18 m/ 59 ft

Accessories

Picture	Order Code	Description
	Mx-M-VD-IC	Ceiling Flush Mount for MOBOTIX MOVE Vandal Dome cameras
	Mx-M-VD-W	Wall Mount set (2 pieces) for MOBOTIX MOVE Vandal Dome cameras
	Mx-M-VD-P	Pole Mount (junction mount) for MOBOTIX MOVE Vandal Dome cameras
	Mx-M-VD-C	Corner Mount for MOBOTIX MOVE Vandal Dome cameras
	Mx-NPA-UPOE1A-60W	UPoE Network Power Injector 60 W
	Mx-A-ETP1A-2601-SET	Media Converter Set Ethernet (PoE+) – Twisted-Pair

Dimensions

NOTE! Download the drilling template from the section or on the MOBOTIX website: www.mobotix.com > [Support > Download Center > Marketing & Documentation > Drilling Templates](#).

CAUTION! Always print or copy the drilling template at 100% of the original size!

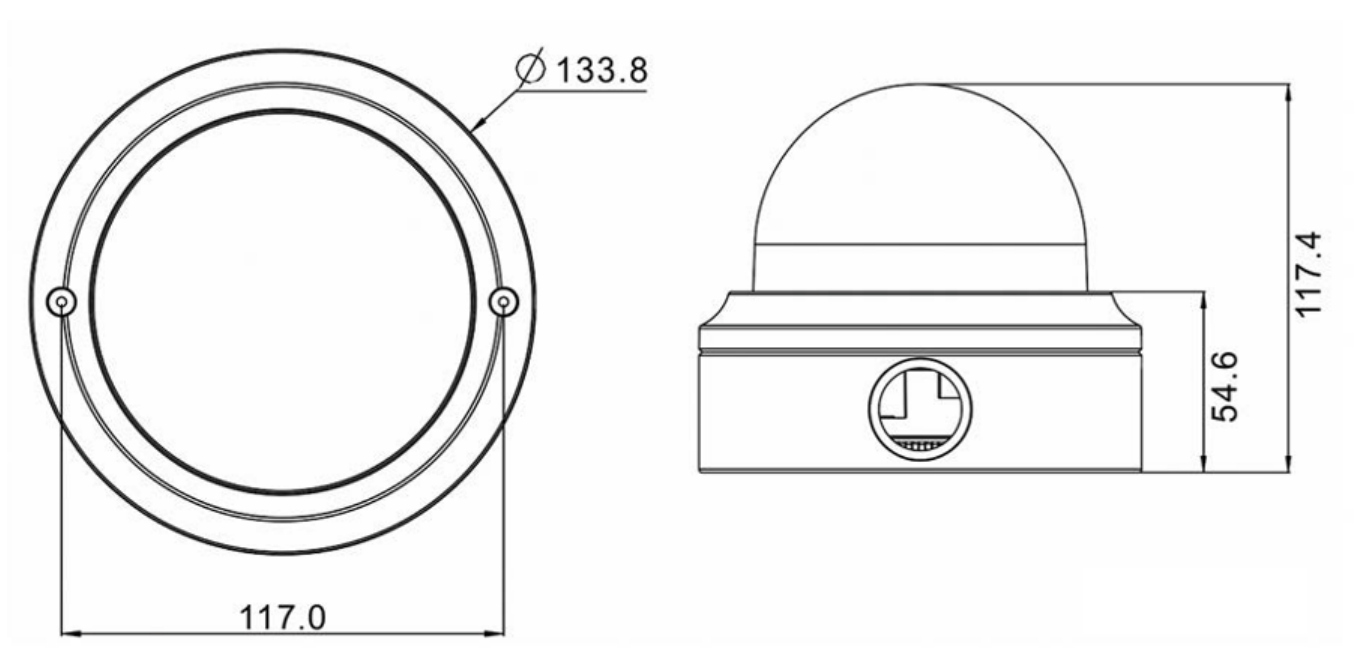

Fig. 1: 4K (8MP) Vandal Fixed Dome Analytics Camera: All measurements in mm

Further Reading

[Manuals and Quick Installation documents](#)



[Video Analytics Manual](#)



[Technical Specifications](#)



[MOBOTIX MOVE Installation Hints](#)



[MOBOTIX Community](#)



MOBOTIX

BeyondHumanVision

EN_07/24

MOBOTIX AG • Kaiserstrasse • D-67722 Langmeil • Tel.: +49 6302 9816-103 • sales@mobotix.com • www.mobotix.com

MOBOTIX is a trademark of MOBOTIX AG registered in the European Union, the U.S.A., and in other countries. Subject to change without notice. MOBOTIX do not assume any liability for technical or editorial errors or omissions contained herein. All rights reserved. © MOBOTIX AG 2020