

Quick Installation

MOBOTIX S74

© 2024 MOBOTIX AG



Table of Contents

Table of Contents	2
Before You Start	5
Support	6
MOBOTIX Support	6
MOBOTIX eCampus	6
MOBOTIX Community	6
Safety Notes	7
Legal Notes	7
Notes on System Security	9
Drilling Template	11
Drilling Template PDF	12
Scope of Delivery	13
MOBOTIX S74: Scope of Delivery	14
Mounting Supplies: Scope of Delivery	15
PTMount: Scope of Delivery	16
PTMount-Thermal: Scope of Delivery	17
Technical Specifications	19
Hardware	20
Average Power Consumption	21
Image and Video Properties	22
General Software Features	23
Video Analysis	24
Video Management Software	24
Sensor Modules	25
Dimensions of Sensor Modules	25
Weight of Sensor Modules	25
Supported Image Sensor Modules	25
Supported Thermal Sensor Modules	27
Features Thermal Image Sensors	28
Features ECO Thermal Image Sensor	29
Functional Modules	30
Interface Slide in Boards	31
S74 Network Slide in Board with RJ45 socket	31
S74 Network Slide in Board with LSA terminal	31
S74 IO Slide in Board	31
S74 Network Slide in Board with RJ45 and VDC power supply - A	32

S74 Network Slide in Board with RJ45 and VDC power supply - B	32
Dimensions	34
PTMount – Dimensions	34
PTMount-Thermal – Dimensions	35
Mounting	37
Before Mounting the Camera	38
Installing Sensor Modules	39
Preparing the Sensor Modules	40
Installing Sensor Module without Mounts	40
Installing Sensor Module with PTMount	41
Installing Sensor Module PTMount-Thermal	48
Installing Slide In Boards	51
Installing the S74 Network Slide in Board with RJ45 socket	51
Installing the S74 Network Slide in Board with LSA terminal	52
Installing the S74 Network Slide in Board with RJ45 and VDC power supply	57
Installing the S74 IO Slide in Board	58
Mounting the Camera	63
Connecting Module Cables to the Camera	65
Sensor Module Combinations	66
Connecting the Camera to the Network	67
Operating the Camera	71
Getting Started	72
LED states	72
Boot Options of the Camera	73
Network Settings	75
Windows	76
Mac	77
Linux / Unix	77
Network Settings on the Camera in the Webbrowser	77
Network Settings on the Camera in MxMC	78
Focusing the TELE 15° Sensor Module	79
Camera Software in the Browser	83
Access the Camera in the Web Browser	84
Basic Settings	84
Configuring Sensor Modules	85
Maintenance	87
Cleaning the Camera and Lenses	88

Before You Start

This section contains the following information:

Support	6
Safety Notes	7
Legal Notes	7

Support

MOBOTIX Support

If you need technical support, please contact your MOBOTIX dealer. If your dealer cannot help you, he will contact the support channel to get an answer for you as quickly as possible.

If you have internet access, you can open the MOBOTIX help desk to find additional information and software updates.

Please visit www.mobotix.com > [Support](#) > [Help Desk](#).



MOBOTIX eCampus

The MOBOTIX eCampus is a complete e-learning platform. It lets you decide when and where you want to view and process your training seminar content. Simply open the site in your browser and select the desired training seminar.

Please visit www.mobotix.com/ecampus-mobotix.



MOBOTIX Community

The MOBOTIX community is another valuable source of information. MOBOTIX staff and other users are sharing their information, and so can you.

Please visit community.mobotix.com.



Safety Notes

- This camera must be installed by qualified personnel and the installation should conform to all local codes.
- This product must not be used in locations exposed to the dangers of explosion.
- Do not use this product in a dusty environment.
- Protect this product from moisture or water entering the housing.
- Install this product as outlined in this document. A faulty installation can damage the product!
- Do not replace batteries of the camera. If a battery is replaced by an incorrect type, the battery can explode.
- This equipment is not suitable for use in locations where children are likely to be present.
- External power supplies must comply with the Limited Power Source (LPS) requirements and share the same power specifications with the camera.
- When using a power adapter, the power cord shall be connected to a socket-outlet with proper ground connection.
- To comply with the requirements of EN 50130-4 regarding the power supply of alarm systems for 24/7 operation, it is highly recommended to use an uninterruptible power supply (UPS) for backing up the power supply of this product.

Legal Notes

Legal Aspects of Video and Sound Recording

You must comply with all data protection regulations for video and sound monitoring when using MOBOTIX AG products. Depending on national laws and the installation location of the cameras, the recording of video and sound data may be subject to special documentation or it may be prohibited. All users of MOBOTIX products are therefore required to familiarize themselves with all applicable regulations and to comply with these laws. MOBOTIX AG is not liable for any illegal use of its products.

Declaration of Conformity

The products of MOBOTIX AG are certified according to the applicable regulations of the EC and other countries. You can find the declarations of conformity for the products of MOBOTIX AG on www.mobotix.com under **Support > Download Center > Marketing & Documentation > Certificates & Declarations of Conformity**.

RoHS Declaration

The products of MOBOTIX AG are in full compliance with European Unions Restrictions of the Use of Certain Hazardous Substances in Electrical and Electronic Equipment (RoHS Directive 2011/65/EC) as far as they are subject to these regulations (for the RoHS Declaration of MOBOTIX, please see www.mobotix.com, **Support > Download Center > Marketing & Documentation > Brochures & Guides > Certificates**).

Disposal

Electrical and electronic products contain many valuable materials. For this reason, we recommend that you dispose of MOBOTIX products at the end of their service life in accordance with all legal requirements and regulations (or deposit these products at a municipal collection center). MOBOTIX products must not be disposed of in household waste! If the product contains a battery, please dispose of the battery separately (the corresponding product manuals contain specific directions if the product contains a battery).

Disclaimer

MOBOTIX AG does not assume any responsibility for damages, which are the result of improper use or failure to comply to the manuals or the applicable rules and regulations. Our General Terms and Conditions apply. You can download the current version of the **General Terms and Conditions** from our website at www.mobotix.com by clicking on the corresponding link at the bottom of every page.

It is the User's responsibility to comply with all applicable local, state, national and foreign laws, rules, treaties and regulations in connection with the use of the Software and Product, including those related to data privacy, the Health Insurance Portability and Accountability Act of 1996 (HIPPA), international communications and the transmission of technical or personal data.

FCC Disclaimer

This equipment has been tested and found to comply with the limits for a Class A digital device, pursuant to part 15 of the FCC Rules. These limits are designed to provide reasonable protection against harmful interference when the equipment is operated in a commercial environment. This equipment generates, uses, and can radiate radio frequency energy and, if not installed and used in accordance with the instruction manual, may cause harmful interference to radio communications. Operation of this equipment in a residential area is likely to cause harmful interference in which case the user will be required to correct the interference at his own expense.

Notes on System Security

To protect the camera against security risks in data technology, the following measures are recommended after the installation has been completed:

MxManagementCenter:

- Menu **View > Wizards & Tools > Secure System:**
 - **Change camera factory default password:** ✓
 - **Enable encrypted HTTPS:** ✓
 - **Disable public access:** ✓
 - **User Management** (for all users):
 - **Force Complex Password:** ✓
 - **Log out on Inactivity:** After 5 min

User interface of the camera in the browser:

- **Admin Menu > Network Setup > Web Server:**
 - **Enable MxWeb:** –
 - **Enable intrusion detection:** ✓
 - **Notification threshold:** 10
 - **Timeout:** 60 minutes
 - **Block IP Address:** ✓

For more information on this new feature, please read the «Cyber Protection Guide» on www.mobotix.com (under Support > Download Center > Documentation > Brochures & Guides > Cyber Security).

Drilling Template

Open this file in a PDF viewer (Acrobat Reader, Foxit Reader, or similar) and print the file **without scaling (original size)**.

NOTE! Download the drilling template from the MOBOTIX website: www.mobotix.com > [Support](#) > [Download Center](#) > [Marketing & Documentation](#) > [Drilling Templates](#).

CAUTION! Always print or copy the drilling template at 100% of the original size!

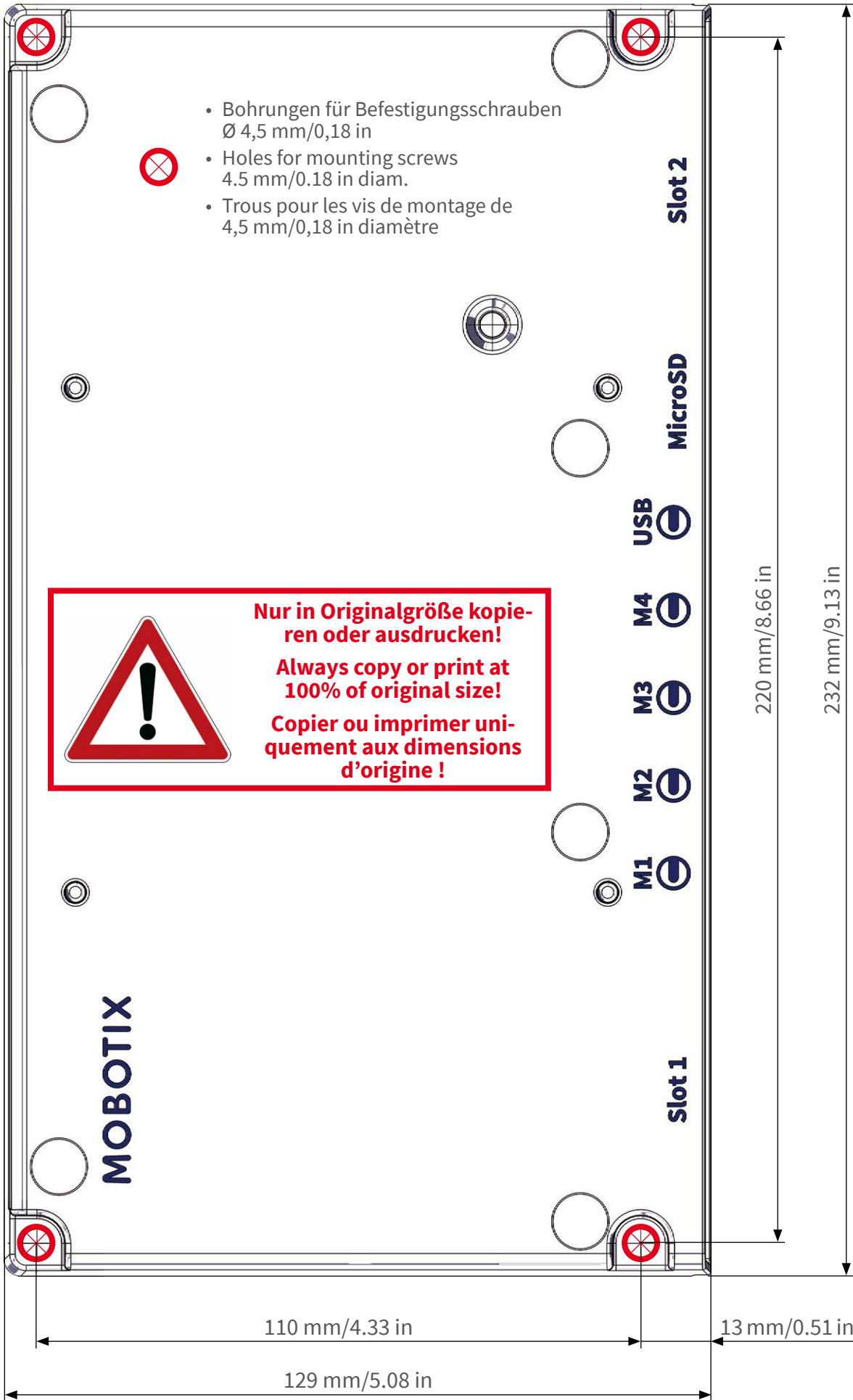

MOBOTIX est une marque déposée de MOBOTIX AG en Union Européenne, aux États-Unis et dans d'autres pays. Susceptible de modification sans préavis. MOBOTIX ne se tient responsable d'aucune erreur technique ou de rédaction, ni d'omission dans le présent document. Tous droits réservés. © MOBOTIX AG 2017
www.mobotix.com > Support > Centre de téléchargement > Documentation > Certificats & Déclarations de conformité

MOBOTIX is a trademark of MOBOTIX AG registered in the European Union, the U.S.A., and in other countries. Subject to change without notice. MOBOTIX do not assume any liability for technical or editorial errors or omissions contained herein. All rights reserved. © MOBOTIX AG 2017
www.mobotix.com > Support > Download Center > Documentation > Certificates & Declarations of Conformity

MOBOTIX ist ein eingetragenes Warenzeichen der MOBOTIX AG in der Europäischen Union, den USA und in anderen Ländern. Änderungen vorbehalten. MOBOTIX übernimmt keine Haftung für technische Fehler, Druckfehler oder Auslassungen. Alle Rechte vorbehalten. © MOBOTIX AG 2017
www.mobotix.com > Support > Download Center > Dokumentation > Zertifikate & Konformitätserklärungen



Scope of Delivery

This section contains the following information:

MOBOTIX S74: Scope of Delivery	14
Mounting Supplies: Scope of Delivery	15
PTMount: Scope of Delivery	16
PTMount-Thermal: Scope of Delivery	17

MOBOTIX S74: Scope of Delivery

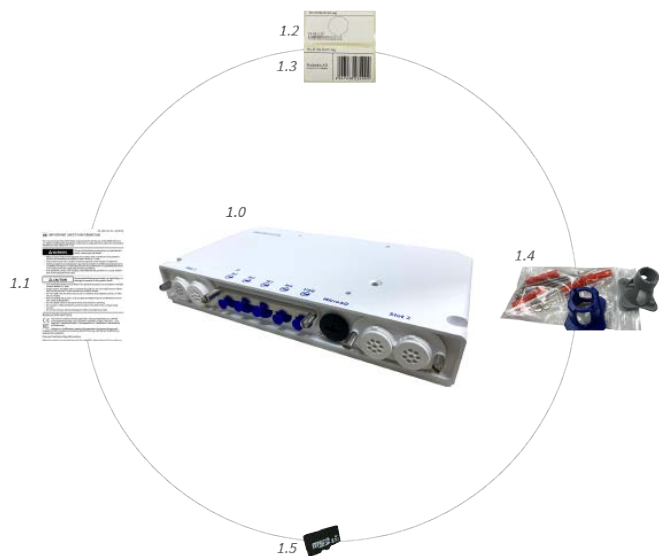

Scope of delivery MOBOTIX S74 Body

Item	Count	Description
1.0	1	MOBOTIX S74, complete
1.1	1	Important Safety Information
1.2	1	Sticker with IP address of camera
1.3	1	Sticker with EAN number of camera
1.4	1	Mounting supplies (see Mounting Supplies: Scope of Delivery, p. 15)
1.5	1	SD card 8 GB (installed)

Mounting Supplies: Scope of Delivery

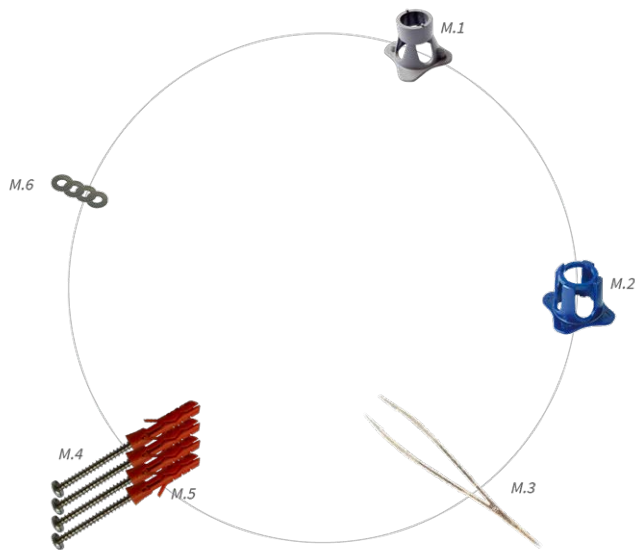

Scope of Delivery MOBOTIX S74 Mounting Supplies

Item	Count	Description
M.1	1	Module wrench (gray)
M.2	1	Lens wrench blue
M.3	1	Tweezers
M.4	4	Wood screw 4.5x60 mm
M.5	4	Dowel S8
M.6	4	Washer

PTMount: Scope of Delivery



Scope of delivery PTMount

Item	Count	Description
PM.1	1	Sphere with rotating insert (installed)
PM.2	1	Foot (installed)
PM.3	1	Base plate (installed)
PM.4	1	Swivel ring (installed)
PM.5	1	Sealing
PM.6	4	Washer Ø 4.3 mm, stainless steel
PM.7	4	Wood screw 4x40 mm, stainless steel
PM.8	4	Screw anchor S6
PM.9	1	Allen wrench 2.5 mm

Scope of delivery PTMount Multisense

Item	Count	Description
PM 1.0	1	PT-Mount with Multisense module (completely pre-mounted)
PM 1.1	1	Sphere with Multisense module (installed)

Scope of delivery PTMount Multisense

Item	Count	Description
PM 1.2	1	Foot (installed)
PM 1.3	1	Base plate (installed)
PM 1.4	1	Swivel ring (installed)
PM 1.5	1	Sealing
PM 1.6	1	Sensor cable 3 m/9.9 ft (installed)
PM 1.7	4	Washer Ø 4.3 mm, stainless steel
PM 1.8	4	Wood screw 4x40 mm, stainless steel
PM 1.9	4	Screw anchor S6
PM 1.10	1	Allen wrench 2.5 mm

PTMount-Thermal: Scope of Delivery



Scope of delivery PTMount-Thermal

Item	Count	Description
PM-T.1	1	Sphere with rotating Thermal/Thermal-TR sensor module (installed)
PM-T.2	1	Foot (installed)

Scope of Delivery

PTMount-Thermal: Scope of Delivery

Scope of delivery PTMount-Thermal

Item	Count	Description
PM-T.3	1	Base plate (installed)
PM-T.4	1	Swivel ring (installed)
PM-T.5	1	Sealing
PM-T.6	4	Sensor cable 2 m/6.6 ft (installed)
PM-T.7	4	Washer Ø 4.3 mm, stainless steel
PM-T.8	4	Wood screw 4x40 mm, stainless steel
PM-T.9	1	Screw anchor S6
PM-T.10	1	Allen wrench 2 mm
PM-T.11	1	Allen wrench 2.5 mm

Technical Specifications

This section contains the following information:

Hardware	20
Image and Video Properties	22
General Software Features	23
Video Analysis	24
Video Management Software	24
Sensor Modules	25
Functional Modules	30
Interface Slide in Boards	31
Dimensions	34

Hardware

Feature	Properties
Image sensor (color or B&W sensor)	up to 4K UHD 3840x2160, 16:9, 1/1,8"
Light sensitivity	<ul style="list-style-type: none"> ▪ Color sensor (day): 0,1 lx @ 1/60s; 0,005 lx @ 1s ▪ BW sensor (night): 0,02 lx @ 1/60s; 0,001 lx @ 1s
Exposure control	Manual and automatic mode 1 s to 1/16,000 s
IK protection class	IK10 (housing)
IP / NEMA protection class	IP66 / NEMA 4X
Operating temperature range	-40 to 65 °C/-40 to 149 °F
Min. cold start temperature	-30 °C/-22 °F
Relative Humidity	95 % non-condensing
Internal DVR Storage	Internal microSD card (SDHC/SDXC), 8 GB out of the box, max. 1 TB.
I/Os	S74 IO Slide in Board, p. 31 required
Microphone/Speaker	S74 IO Slide in Board, p. 31 required
Passive infra-red sensor (PIR)	Available with functional module, max. 4.5 Watt (see Functional Modules, p. 30)
Infra-red illumination	Three functional modules for wide-angle, standard, and tele lenses
Range of infra-red illumination	Up to 30 m/100 ft (may be more depending on scene)
Max. power consumption	max. 25 W
Electrical surge protection	S74 Network Slide in Board with LSA terminal, p. 31 or S74 Network Slide in Board with RJ45 and VDC power supply - A , p. 32 required
PoE standard	PoE Plus (802.3at-2009)/Class 4 (Network slide in Board required. See Interface Slide in Boards, p. 31)
Interfaces	4 sensor / functional modules USB-C 2 Slots for slide in boards (Network, IOs etc.)

Feature	Properties
Mounting Options	Wall-mountable
Dimensions (height x width x depth)	36 x 232 x 110 mm
Weight without sensor modules	1.130g
Housing	Aluminum, PBT-30GF
Standard accessories	See MOBOTIX S74: Scope of Delivery , p. 14
Detailed technical documentation	www.mobotix.com > Support > Download Center > Marketing & Documentation
MTBF	80,000 hours
Certificates	EN 50121-4, EN 55032, EN 55035, EN 61000-6-1, EN 61000-6-2, EN 61000-6-3, EN 61000-6-4, EN 62368-1, EN 63000, AS/NZS CISPR32, 47 CFR Part 15b
Protocols	DHCP (client and server), DNS, ICMP, IGMP v3, IPv4, IPv6, HTTP, HTTPS, FTP, FTPS, NFS, NTP (client and server), RTP, RTCP, RTSP, SFTP, SIP (client and server), SMB/CIFS, SNMP, SMTP, SSL/TLS 1.3, TCP, UDP, VLAN, VPN, Zero-conf/mDNS
Manufacturer warranty	5 years

Average Power Consumption

System	Modules	Average power consumption
S74 - Body	Body only	8.1 W
S74 - Audio, no Video	Audio	8.1 W
S74 - 4K, 12MP, IR, WL, Audio	Audio: PCB + Module M1: 4K Day/Night DN050 M2: IR 850nm wide M3: 12MP Day/Night DN016	19.5 W

Technical Specifications

Image and Video Properties

System	Modules	Average power consumption
S74 - 4K, Thermal, IR, WL, Audio	Audio: PCB + Module M1: 4K Day/Night DN050 M2: IR 850nm wide M3: Thermografic Sensor 640R080 M4: White Light 5700K wide	20.9 W
S74 - Thermal, Multisense, WL, Audio	Audio: PCB + Module M1: 4K Day/Night DN050 M2: Multisense M3: Thermografic Sensor 640R080 M4: White Light 5700K wide	16.5 W

Image and Video Properties

Feature	Properties
Available video codecs	<ul style="list-style-type: none">▪ H.264, H.265▪ MxPEG+▪ MJPEG
Image resolutions	VGA 640x360, XGA 1024x576, HD 1280x720, FullHD 1920x1080, QHD 2560x1440, 4K UHD 3840x2160
Multi streaming	H.264, H.265 with triple streaming
Multicast stream via RTSP	Yes
Max. image H.264 resolution	<ul style="list-style-type: none">▪ One sensor: 4K UHD, 3840x2160 (8MP)▪ Both sensors (dual image): 2x 4K UHD, 7680x2160 (16MP)
Max. frame rate	MxPEG: 20@4K, H.264: 30@4K, H.265: 30@4K

General Software Features

Feature	Properties
WDR	Up to 120 dB
Software features	<ul style="list-style-type: none"> ▪ H.264, H.265 Multistreaming ▪ Multicast stream via RTSP ▪ Digital pan, tilt, zoom/vPTZ (up to 8x zoom) ▪ Genetec protocol integration ▪ Programmable exposure zones ▪ Snapshot recording (pre/post-alarm images) ▪ Continuous recording ▪ Event recording ▪ Time-controlled flexible event logic ▪ Weekly schedules for recordings and actions ▪ Event video and image transfer via FTP and email ▪ Playback and QuadView via web browser ▪ Animated logos on the image ▪ Master/Slave functionality ▪ Privacy zone scheduling ▪ Remote alarm notification (network message) ▪ Programming interface (HTTP-API) ▪ MxMessageSystem
ONVIF compatibility	Profile G, S, T, (M with later firmware release)
Master/Slave functionality	Yes
Remote alarm notification	email, network message (HTTP/HTTPS), SNMP, MxMessageSystem, MQTT
DVR/image storage management	<ul style="list-style-type: none"> ▪ On internal microSD card ▪ On external USB and NAS devices ▪ Different streams for live image and recording ▪ MxPEG+ only ▪ MxFFS with buffered archive, pre- and post-alarm images, storage monitoring with error reporting

Technical Specifications

Video Analysis

Feature	Properties
Camera and data security	User and group management, SSL connections, IP-based access control, IEEE 802.1X, intrusion detection, digital image signature
Digitally signed firmware	Yes (to prevent firmware file tampering)

Video Analysis

Feature	Properties
Video motion detection	Yes
MxActivitySensor	Version 1.0, 2.1, 3.0 and object-based MxAnalytics AI
MxAnalytics	Yes with a later FW release
MOBOTIX App support	Yes with a later FW release

Video Management Software

Feature	Properties
MOBOTIX HUB	Yes www.mobotix.com > Support > Download Center > Software Downloads
MxManagementCenter	Yes (latest version recommended) www.mobotix.com > Support > Download Center > Software Downloads
MOBOTIX Cloud	Streaming & Events supported
MOBOTIX LIVE App	Yes (available in Google Play Store (Android) and Apple App Store (iOS)).
3rd Party VMS Software	see ONVIF Profile S, T and G specification

Sensor Modules

Dimensions of Sensor Modules

Dimensions (height x width)	58 x 42,5 (50 mm)
--------------------------------	-------------------

Weight of Sensor Modules

Sensor Module	Weight
Standard Sensor Modules	max. 150g
Functional Modules	max. 150g
Thermal Sensor Module	380g
PTMount Thermal	890g

Supported Image Sensor Modules

Sensor Module	Order Code
Sensor module with standard 45° lens	Mx-O-M7SA-8DN100*
	Mx-O-M7SA-8D100
	Mx-O-M7SA-8N100*
	Mx-O-M7SA-4DN100
Sensor module with tele lens 30°	Mx-O-M7SA-8DN150*
	Mx-O-M7SA-8D150
	Mx-O-M7SA-8N150*
	Mx-O-M7SA-4DN150
	Mx-O-M7SA-8L150

Technical Specifications

Sensor Modules

Sensor Module	Order Code
Sensor module with tele lens 15°	Mx-O-M7SA-8DN280*
	Mx-O-M7SA-8D280
	Mx-O-M7SA-8N280*
	Mx-O-M7SA-4DN280
	Mx-O-M7SA-8L280
Sensor module with tele lens 8°	Mx-O-M7SA-8D500
	Mx-O-M7SA-8N500
	Mx-O-M7SA-8L500
Sensor module with wide angle lens 60°	Mx-O-M7SA-8DN080*
	Mx-O-M7SA-8D080
	Mx-O-M7SA-8N080*
	Mx-O-M7SA-4DN080
Sensor module with super wide angle lens 95°	Mx-O-M7SA-8DN050*
	Mx-O-M7SA-8D050
	Mx-O-M7SA-8N050*
	Mx-O-M7SA-4DN050
Sensor module with ultra wide angle lens 120° 4K	Mx-O-M7SA-8DN040*
	Mx-O-M7SA-8D040
	Mx-O-M7SA-8N040*
	Mx-O-M7SA-4DN040
	Mx-O-M7SA-8L040
Sensor module with hemispheric lens 180° 12MP	Mx-O-M7SA-12DN016*

*also available in black.

NOTE! Please consider any lens-related restrictions. For example, license plate recognition is not possible with a hemispheric lens.

For a complete list of lenses for MOBOTIX cameras, please see the Lens Table document for MOBOTIX 7 models on www.mobotix.com > [Support](#) > [Download Center](#) > [Marketing & Documentation](#) > [Lens Table](#).

Supported Thermal Sensor Modules

Sensor module	Order code
CIF Thermal 45° x 35°	MX-O-M7SB-336TS100
CIF Thermal 25° x 19°	Mx-O-M7SB-336TS150
CIF Thermal 17° x 13°	Mx-O-M7SB-336TS280
CIF Thermal Radiometry 45° x 35°	Mx-O-M7SB-336RS100
CIF Thermal Radiometry 25° x 19°,	Mx-O-M7SB-336RS150
CIF Thermal Radiometry 17° x 13°	Mx-O-M7SB-336RS280
CIF Thermal Radiometry 9,3° x 7,1°	Mx-O-M7SB-336RS500 (BTO)
ECO CIF Thermal 105°x75°	Mx-O-M7SA-320T040
ECO CIF Thermal 56°x42°	Mx-O-M7SA-320T080
VGA Thermal 90° x 69°	Mx-O-M7SB-640TS050
VGA Thermal 69° x 56°	Mx-O-M7SB-640TS080
VGA Thermal 45° x 37°	Mx-O-M7SB-640TS100
VGA Thermal 32° x 26°	Mx-O-M7SB-640TS150
VGA Thermal Radiometry 90° x 69°	Mx-O-M7SB-640RS050
VGA Thermal Radiometry 69° x 56°	Mx-O-M7SB-640RS080
VGA Thermal Radiometry 45° x 37°	Mx-O-M7SB-640RS100
VGA Thermal Radiometry 32° x 26°	Mx-O-M7SB-640RS150
VGA Thermal Radiometry 18° x 14°	Mx-O-M7SB-640RS280 (BTO)

The **Thermal Radiometry (TR)** variants automatically alarm when the temperature exceeds or falls below defined limits. This is crucial for the detection of fire or heat sources. Up to 20 different temperature events can be configured simultaneously in so-called TR windows or over the complete sensor image over a

Technical Specifications

Sensor Modules

temperature range of High Sensitivity: -40 to 170 °C/-40 to 320 °F -- Low Sensivity: -40 to 550 °C/-40 to 1022 °F .

The **Thermal (non-TR)** variants only measure in the center of the image (Thermal spot, 2x2 pixel).

Features Thermal Image Sensors

Feature	Properties																				
Thermal sensitivity	Typ. 50 mK, IR range 7.5 to 13.5 μm																				
Temperature measurement range (adjustable)	High Sensitivity: -40 to 170 °C/-40 to 320 °F -- Low Sensivity: -40 to 550 °C/-40 to 1022 °F																				
Thermal image sensor	Uncooled microbolometer, CIF: 336 x 256 pixels / VGA: 640 x 480																				
Dimensions	PT mount Thermal 336/640: 98.5mm x 106mm diam, 620g (including PT Mount Sensor module alone: 73mm (+4.4mm front glass) x 57mm diam (63mm front glass), 310g																				
Max. image size	Can be scaled up to 3072 x 2048 (6MP), automatically scaled to size of MX sensor module																				
Max. frame rate	9fps (-FAST version 25/30fps on request)																				
Pixel pitch	17μm																				
Field of view	<table><thead><tr><th>Sensor Module</th><th>FoV</th></tr></thead><tbody><tr><td>336 xx 100</td><td>45° x 35°; 2.27mr, focal 7.5mm, f/1.25</td></tr><tr><td>336 xx 150</td><td>25° x 19°; 1.31mr, focal 13mm, f/1.25</td></tr><tr><td>336 xx 280</td><td>17° x 13°; 0.90mr, focal 19mm, f/1.25</td></tr><tr><td>336 xx 500</td><td>9° x 7°; 0.486mr, focal length 35mm, f/1.5</td></tr><tr><td>640 xx 050</td><td>90° x 69°; 2.27mr, focal 7.5mm, f/1.4</td></tr><tr><td>640 xx 080</td><td>69° x 56°; 1.89mr, focal 9mm, f/1.4</td></tr><tr><td>640 xx 100</td><td>45° x 37°; 1.31mr, focal 13mm, f/1.25</td></tr><tr><td>640 xx 150</td><td>32° x 26°; 0.90mr, focal 19mm, f/1.25</td></tr><tr><td>640 xx 280</td><td>18°x14°; 0.486mr, focal length 35mm, f/1.5</td></tr></tbody></table>	Sensor Module	FoV	336 xx 100	45° x 35°; 2.27mr, focal 7.5mm, f/1.25	336 xx 150	25° x 19°; 1.31mr, focal 13mm, f/1.25	336 xx 280	17° x 13°; 0.90mr, focal 19mm, f/1.25	336 xx 500	9° x 7°; 0.486mr, focal length 35mm, f/1.5	640 xx 050	90° x 69°; 2.27mr, focal 7.5mm, f/1.4	640 xx 080	69° x 56°; 1.89mr, focal 9mm, f/1.4	640 xx 100	45° x 37°; 1.31mr, focal 13mm, f/1.25	640 xx 150	32° x 26°; 0.90mr, focal 19mm, f/1.25	640 xx 280	18°x14°; 0.486mr, focal length 35mm, f/1.5
Sensor Module	FoV																				
336 xx 100	45° x 35°; 2.27mr, focal 7.5mm, f/1.25																				
336 xx 150	25° x 19°; 1.31mr, focal 13mm, f/1.25																				
336 xx 280	17° x 13°; 0.90mr, focal 19mm, f/1.25																				
336 xx 500	9° x 7°; 0.486mr, focal length 35mm, f/1.5																				
640 xx 050	90° x 69°; 2.27mr, focal 7.5mm, f/1.4																				
640 xx 080	69° x 56°; 1.89mr, focal 9mm, f/1.4																				
640 xx 100	45° x 37°; 1.31mr, focal 13mm, f/1.25																				
640 xx 150	32° x 26°; 0.90mr, focal 19mm, f/1.25																				
640 xx 280	18°x14°; 0.486mr, focal length 35mm, f/1.5																				
Operating temperature	-40° to +65°C / 40° to 149°F; 5% to 95% non-condensing																				

Feature	Properties
Power consumption	CIF: 1W VGA: 1.2W
MTBF	80,000 hours
IP rating	IP67
IK rating	IK04
Material	PBT-30GF (housing); Germanium (lens)
Software (included)	Video management software MxManagementCenter

Features ECO Thermal Image Sensor

Feature	Properties
Thermal sensitivity	Typ. 65 mK, IR range 7.8 to 14 μm
Temperature measurement range	-40 to 330°C / -40 to 626 °F
Field of view	T040: 105 x 75°; 5,23mr, focal 2.2mm, f/1.05 T080: 56 x 42°; 3,00mr, focal 4.0mm, f/1.00
Thermal image sensor	Uncooled microbolometer, CIF: 320 x 240 pixels
Dimensions	58 x 42.5 mm (dia. 50 mm), 65g
Pixel pitch	12μm
Max. image size	Can be scaled up to 3072 x 2048 (6MP), automatically scaled to size of MX Sensor module
Max. frame rate	9 fps (when displaying an Mx Sensor module and a thermal sensor module, the overall frame rate of the camera is reduced to 9 fps)
Operating temperature	-40° to +65°C / 40° to 149°F; 5% to 95% non-condensing
Power consumption	600mW
IP rating	IP66
IK rating	IK04

Technical Specifications

Functional Modules

Feature	Properties
Material	PBT-30GF (housing); Chalcogenide (lens)
Software (included)	Video management software MxManagementCenter

Functional Modules

Functional Module	Order Code	Remark
Audio module		via S74 IO Slide in Board
Functional MultiSense module	Mx-F-MSA	with PIR sensor, temperature sensor, illumination sensor
Functional IR Light modules	Mx-F-IRA-W	for Super Wide-Angle Lens Sensor Modules 95°
	Mx-F-IRA-S	for Standard & Wide-Angle Lens Sensor Modules 45° and 60°
	Mx-F-IRA-T	for Tele Lens Sensor Modules 15° and 30°
White Light Modules	Mx-F-WLA-W	for Super Wide-Angle Lens Sensor Modules 95°
	Mx-F-WLA-S	for Standard & Wide-Angle Lens Sensor Modules 45° and 60°
	Mx-F-WLA-T	for Tele Lens Sensor Modules 15° and 30°
		Power consumption IR Light Modules: 4,2 W at 100% brightness.
		Power consumption White Light Modules: 3,2 W at 100% brightness.

Interface Slide in Boards

S74 Network Slide in Board with RJ45 socket

Order Code	Mx-F-S7A-RJ45
Power Supply	PoE Plus (802.3at-2009)/Class 4
Network	RJ45 / Ethernet 1000Base-T

S74 Network Slide in Board with LSA terminal

Order Code	Mx-F-S7A-LSA
Power Supply	PoE Plus (802.3at-2009)/Class 4
Network	LSA / Ethernet 1000Base-T
Overvoltage Protection	max. 4 kV on the PoE network cabling

S74 IO Slide in Board

Order Code	Mx-F-S7A-INT01
------------	----------------

Terminal	Remark
Line Out	Headphones with 20mW @ 16 Ohm or 32 Ohm. Audio inputs as a Line Out function to 10k Ohm impedance of receiver. Audio level while connected to 10k Ohm equals -10dbV
Line In	Standard Line In: (0dB) Vrms=1V
SPK	0,9W at any 8 Ohm speaker. MOBOTIX Audio module: 0,9W at 8 Ohm
MIC	Passive microphone to connect (for best results). R_Bias for the microphone is 2.2 kOhm (included on the camera). Microphone impedance < 2.2 kOhm, Operating voltage of the microphone is 2V. Sensitivity of the MOBOTIX Audio Module: -35 +/-4dB (0dB = 1V/pa, 1kHz)

Technical Specifications

Interface Slide in Boards

Terminal	Remark
IN	<ul style="list-style-type: none">▪ Contact Closure (no galvanic isolation necessary) or up to 50V AC/DC▪ max. length for cables: 50m
OUT	<ul style="list-style-type: none">▪ requires pull-up resistor and external power supply (10mA / max. 50V DC - no AC)▪ Output may be loaded with max. 50mA▪ max. length for cables: depends on loop impedance of the connected cable.

Allowed cable dimensions for cables connected to the PCB terminals

AWG	20 - 26
Rigid	0.14mm ² - 0.5mm ²
Flexible	0.14mm ² - 0.5mm ²
Flexible with ferrule	0.25mm ² - 0.34mm ²

S74 Network Slide in Board with RJ45 and VDC power supply - A

Order Code	Mx-F-S7A-RJ45-VDC
Power Supply	12-24 V DC only - recommended 2,5-1,5A
Network	RJ45 / Ethernet 1000Base-T

Allowed cable dimensions for cables connected to the PCB terminals

AWG	26 - 20
Rigid	0.14mm ² - 0.5mm ²
Flexible	0.14mm ² - 0.5mm ²
Flexible with ferrule	0.25mm ² - 0.34mm ²

S74 Network Slide in Board with RJ45 and VDC power supply - B

Order Code	Mx-F-S7B-RJ45-VDC
Power Supply	12-24 V DC only - recommended 2,5-1,5A

Network	RJ45 / Ethernet 1000Base-T
---------	----------------------------

Allowed cable dimensions for cables connected to the PCB terminals

AWG	26 - 14
Rigid	0.14mm ² - 2.5mm ²
Flexible	0.14mm ² - 1.5mm ²
Flexible with ferrule	0.25mm ² - 1.5mm ²

Dimensions

NOTE! Download the drilling template from the MOBOTIX website: www.mobotix.com > [Support](#) > [Download Center](#) > [Marketing & Documentation](#) > [Drilling Templates](#).

CAUTION! Always print or copy the drilling template at 100% of the original size!

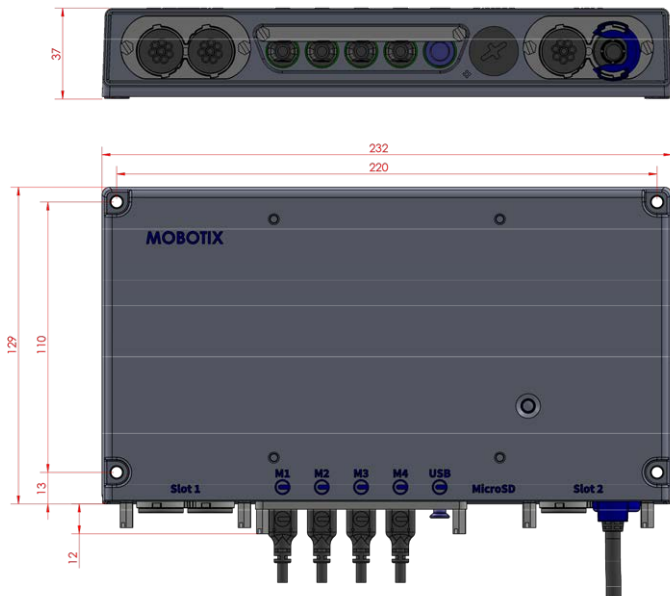

Fig. 1: MOBOTIX S74: All measurements in mm

PTMount – Dimensions

NOTE! Download the drilling template from the MOBOTIX website: www.mobotix.com > [Support](#) > [Download Center](#) > [Marketing & Documentation](#) > [Drilling Templates](#).

CAUTION! Always print or copy the drilling template at 100% of the original size!

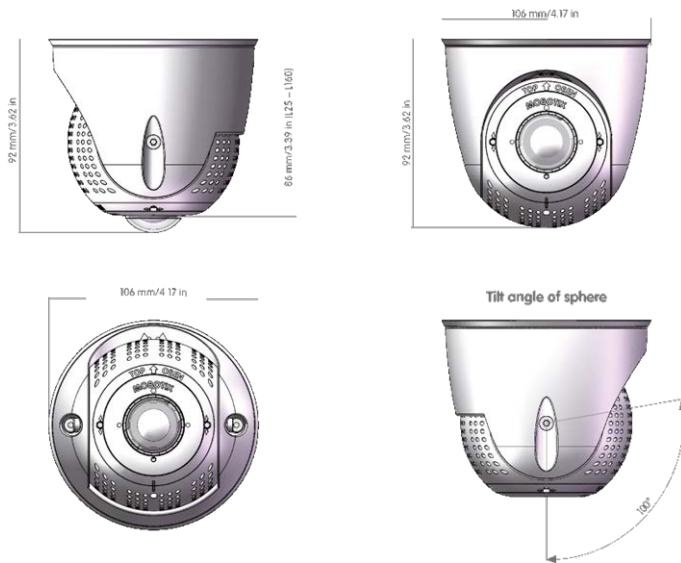

Fig. 2: PTMount

PTMount-Thermal – Dimensions

NOTE! Download the drilling template from the MOBOTIX website: www.mobotix.com > Support > Download Center > Marketing & Documentation > Drilling Templates.

CAUTION! Always print or copy the drilling template at 100% of the original size!

Technical Specifications

Dimensions

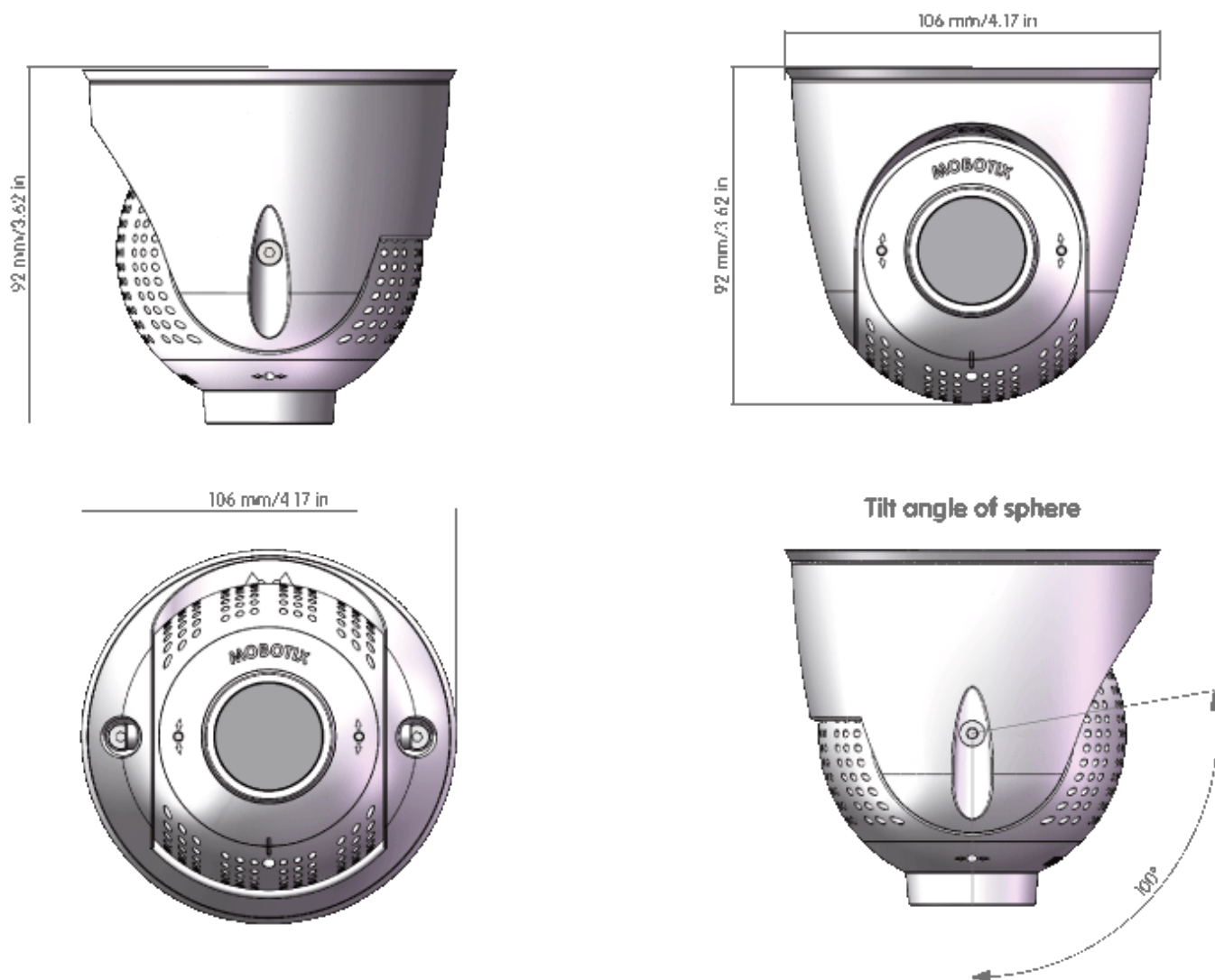

Fig. 3: PTMount-Thermal

Mounting

This section contains the following information:

Before Mounting the Camera	38
Installing Sensor Modules	39
Installing Slide In Boards	51
Mounting the Camera	63
Connecting Module Cables to the Camera	65
Connecting the Camera to the Network	67

Before Mounting the Camera

Before mounting the MOBOTIX S74, the following questions should be answered:

- Where and how will the camera be mounted?
- Where and how will the sensor modules be mounted?
- How is the mounting surface level?
- Which other mounting options are available?
- Which accessories might be needed?
- How is the camera connected to the network and how is the power supplied?
- How are the connections furnished from the building?
- What cabling considerations are necessary?

CAUTION! Installation only on flat surface!

Only use genuine MOBOTIX patch cables to guarantee the weatherproofness!

If you have questions, please ask your MOBOTIX partner directly or contact the MOBOTIX support under www.mobotix.com > [Support](#) > [Help Desk](#).

Protective Measures

WARNING! When laying cables indoors and outdoors, the current regulations for cable laying, lightning and fire protection must always be observed.

MOBOTIX cameras and devices are protected against the effects of minor over voltages by a number of measures. However, these measures cannot prevent larger surge voltages from causing damage to the camera. When installing the cameras outdoors, special attention should therefore be paid to lightning protection and the associated dangers for the building and network infrastructure.

In general, you should only have MOBOTIX cameras and devices installed by certified specialist companies that are familiar with the installation and safe operation of network devices and the underlying regulations for lightning and fire protection as well as the current technology for preventing damage from surge voltages.

Notes on Cable Laying

- **Data cable:** Only double-shielded CAT5 cable or better (S/STP) may be used as data cable for the Ethernet interface.

NOTE! For outdoor use, special requirements apply for the cables to be used and the lightning protection.

- **Cable length:** The individual cable sections must not exceed the maximum permissible lengths in order to ensure perfect data transmission.
- **Avoidance of induction:** Data cables may only be laid parallel to power or high-voltage lines if the prescribed minimum distances are observed.
- Only use MOBOTIX cables and connectors to ensure IP66 weather resistance.

Fire Protection

When laying cables for the power supply, the relevant country-specific regulations (e.g. VDE in Germany) and the fire protection regulations valid at the installation site must be observed.

Lightning and Surge Protection

Measures should always be taken to protect this device from electrical surge damage.

NOTE! Electrical surge protection is integrated in the S74 Network Slide in Board with LSA terminal (see [Installing the S74 Network Slide in Board with LSA terminal, p. 52](#)), which is available as an accessory.

Further information on how to avoid damage caused by lightning and over voltage is available from manufacturers of lightning and over voltage protection devices.

Installing Sensor Modules

WARNING! Make sure the power supply to the camera is disconnected before installing or replacing sensor modules.

CAUTION! When installing the sensor modules, make sure that the sensor module cables are not damaged or bent sharply!

Preparing the Sensor Modules

Remove the plastic nut ① from the sensor modules, remove the bayonet catch ② by rotating it counter-clockwise, then remove the blue rubber plug ③ .

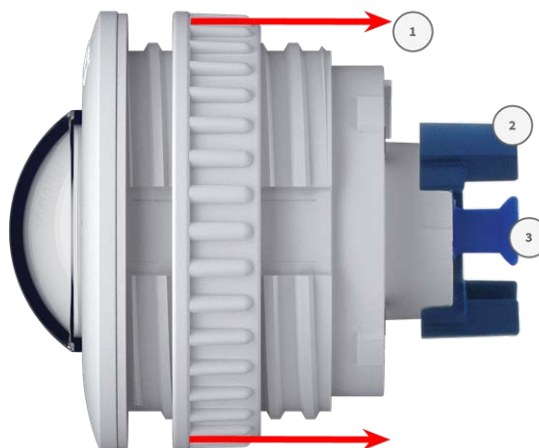

Proceed by Installing the Sensor Modules

-

[Installing Sensor Module without Mounts, p. 40](#)

- [Installing Sensor Module with PTMount, p. 41](#)
- [Installing Sensor Module PTMount-Thermal, p. 48](#)

Installing Sensor Module without Mounts

1. **Mount the sensor module:** Insert sensor module into hole (43 mm) ① and tighten the plastic nut ② to keep the sensor module safely in place



2. **Connect the sensor module cable:** Push the plug of each sensor module cable **firmly** into the connector at the back of the module until the connector is fully inserted into its seat until it doesn't go in any further.



CAUTION! The lug of the plug must point to the inside of the sensor module when plugged in. If the module cable is not plugged in correctly, the sensor will not be recognized by the camera.

3. **Lock sensor module cable:** Apply the blue bayonet catch onto the connector of the sensor module as shown and turn it clockwise until it gently snaps shut.



4. Repeat steps 1 to 4 to add additional sensor modules, respectively.

Installing Sensor Module with PTMount

CAUTION! The PT-Mount was developed for wall or ceiling mounting. When mounting on the floor, make sure that there is no cavity inside the PT-Mount where water could collect.

Mounting

Installing Sensor Modules

1. Using the 2.5 mm allen wrench, remove the two screws that hold the foot onto the swivel ring.



2. Remove swivel ring and base plate.



3. Make sure that there is enough space for installing the PTMount and that you can access it from the rear later on. The surface should be even and smooth so that the sealing lies flat on the surface.



4. Drill the holes for the base plate using the drilling template and insert the screw anchors [PTMount: Scope of Delivery, p. 16](#).



5. In the center of the drilling template, drill another hole into the wall or faceplate for the sensor module cable. The hole should have a diameter between 15 and 35 mm.



6. Hold the sealing, the swivel ring and the base plate as shown in the figure.



7. Attach the base plate using the supplied wood screws and washers.



Mounting

Installing Sensor Modules

- When tightening the screws, make sure that you can still rotate the swivel ring by hand.



- Guide the sensor cable through the sealing, the swivel ring, the base plate and through the mounting surface to the camera.



- Guide the sensor cable from the back into the foot and the sphere.

- Use the two screws to affix the foot and sphere assembly to the swivel ring and make sure that the foot can still be rotated.



- Loosen the two fastening screws of the insert ① , then rotate the insert so that the small bar opposite of the **TOP/OBEN** label points to the hole of the grub screw ② .

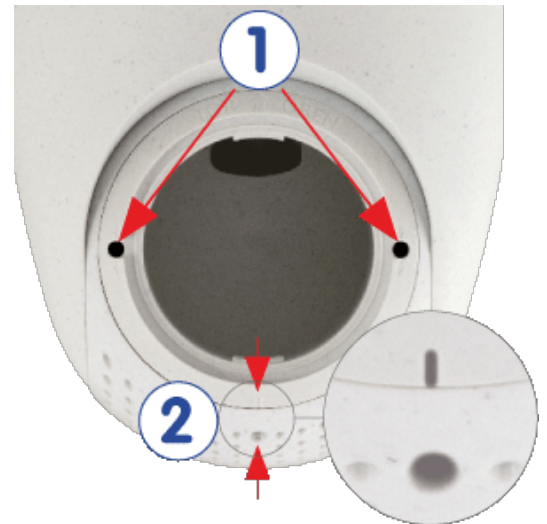

- Secure the insert against rotating by tightening the two fastening screws using the 2.5 mm Allen wrench.
- Attach the sensor module cable to the sensor module (turn blue bayonet catch to the left and remove, pull out the plug, connect the sensor cable, apply bayonet catch and lock by turning to the right).



- Push the sensor module into the PTMount so that the arrow on the backside of the sensor module points to the left vs. the **TOP/OBEN** lettering.



Mounting

Installing Sensor Modules

16. Using the module wrench lock the sensor module by turning it 90 degrees to the right.



17. Secure the sensor module by tightening the grub screw using the 2.5 mm Allen wrench. The grub screw locks the sensor module within the insert and prevents inadvertent unlocking of the sensor module.



18. Adjust the sensor module temporarily by pointing it into the desired viewing direction.



19. Make sure that the **TOP/OBEN** label on the insert is pointing upwards. If this is not the case, loosen the two fastening screws using the 2.5 mm Allen wrench and rotate the insert.



Installing Sensor Module PTMount-Thermal

1. Using the 2.5 mm Allen wrench, remove the two screws that hold the foot onto the swivel ring.



2. Remove swivel ring and base plate.



3. Make sure that there is enough space for installing the PTMount-Thermal and that you can access it from the rear later on. The surface should be even and smooth so that the sealing lies flat on the surface.
4. Use the base plate as drilling template and drill the holes for the base plate and insert the screw anchors [PTMount-Thermal: Scope of Delivery, p. 17](#).



5. In the center of the drilling template, drill another hole into the wall or faceplate for the sensor module cable. The hole should have a diameter between 15 and 35 mm.



6. Attach the base plate and the swivel ring using the supplied wood screws and washers.
When tightening the screws, make sure that you can still rotate the swivel ring by hand.



7. Guide the sensor cable through the swivel ring and the base plate.



Mounting

Installing Sensor Modules

8. Use the two screws to affix the foot and sphere assembly to the swivel ring and make sure that the foot can still be rotated.



9. Adjust the sensor module temporarily by pointing it into the desired viewing direction.



10. Make sure that the **MOBOTIX** label on the insert is pointing upwards. If this is not the case, loosen the two fastening screws with the 2 mm Allen wrench and rotate the insert. Lightly tighten the two fastening screws.



Installing Slide In Boards

WARNING! Make sure the power supply to the camera is disconnected before installing or replacing slide in board.

Installing the S74 Network Slide in Board with RJ45 socket

The S74 Network Slide in Board with RJ45 socket is required to connect the camera to the network and to supply power via PoE. The S74 Network Slide in Board with RJ45 socket is not part of the scope of delivery (see [Scope of Delivery, p. 13](#)) and must be ordered in addition to the camera.



Fig. 4: S74 Network Slide in Board with RJ45 socket

CAUTION! The S74 Network Slide in Board with RJ45 socket may only be installed in slot 2 of the camera!

CAUTION! Do not connect to the network at this stage!

Since the camera must not run without sensor modules, the network connection will be established only **after** mounting the camera and connecting the sensor modules.

Procedure

1. **Remove cover from slot 2 of the camera:** Use a screwdriver to loosen both bolt screws ① and then pull out the plastic cover.

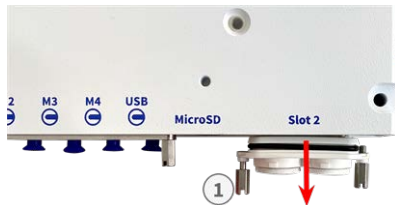

Fig. 5: Remove cover from interface board slot

2. **Connect the S74 Network Slide in Board with RJ45 socket:** Position the interface board on the guide rails in the slide-in slot and push it in with slight pressure until it clicks into the socket. Then fix the board with the screw bolts ①.

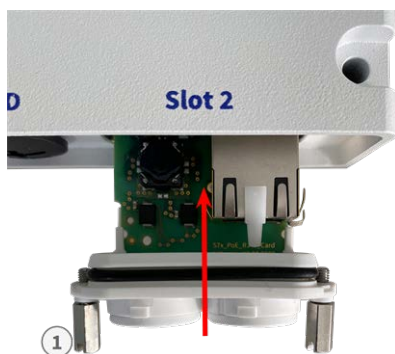

Fig. 6: Connecting the S74 Network Slide in Board with RJ45 socket

CAUTION! Do not connect the network cable at this stage! Since the camera must not run without sensor modules, the network connection will be established only **after** mounting the camera and connecting the sensor modules.

Installing the S74 Network Slide in Board with LSA terminal

The S74 Network Slide in Board with LSA terminal is required to connect the camera to the network, to supply power via PoE and to protect the camera from electrical surge. The S74 Network Slide in Board with LSA terminal is not part of the scope of delivery (see [Scope of Delivery, p. 13](#)) and must be ordered in addition to the camera.



Fig. 7: S74 Network Slide in Board with LSA terminal

CAUTION! The S74 Network Slide in Board with LSA terminal may only be installed in slot 2 of the camera!

CAUTION! Do not connect to the network at this stage!

Since the camera must not run without sensor modules, the network connection will be established only **after** mounting the camera and connecting the sensor modules.

Prepare S74 Network Slide in Board with LSA terminal and cable

NOTE! You will need an LSA+/Krone tool for this procedure:



Fig. 8: LSA+/Krone tool

1. **Remove cover from slot 2 of the camera:** Use a screwdriver to loosen both bolt screws ① and then pull out the plastic cover.

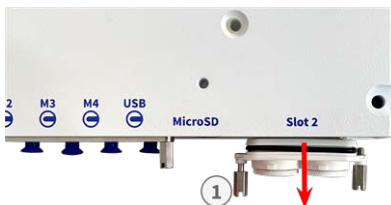
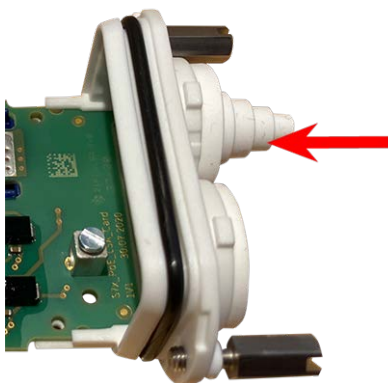

Fig. 9: Remove cover from interface board slot

2. Cut off two steps of the of the white plug in the cover of the interface board ① .



Mounting

Installing Slide In Boards

3. Insert the network cable into the white rubber plug:

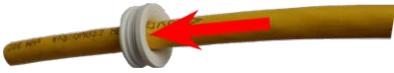

4. Remove the insulation from the network cable as shown below:

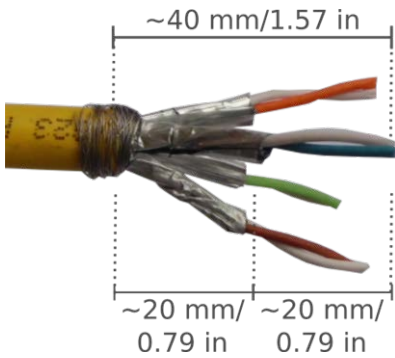

Attach the Network Cable to the S74 Network Slide in Board with LSA terminal

1. Insert the network cable into the Interface a board and make sure the rubber plug is properly seated all around the opening:

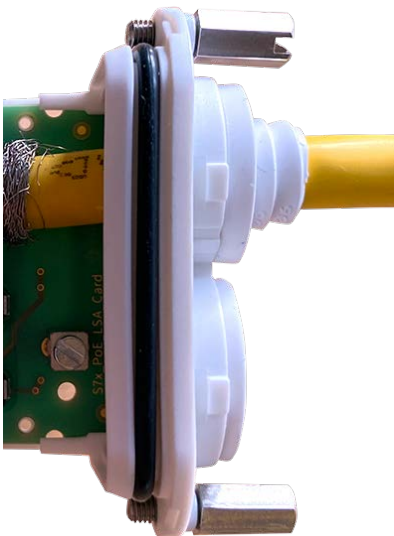

Fig. 10: Network cable inserted, plug properly seated

2. Insert the cable tie into the blue guides ① , tie down the network cable ② onto the copper-colored ground plate and cut off the protruding part of the cable tie:

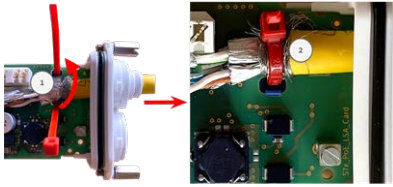

Fig. 11: Cable tie inserted beneath network cable

3. Prepare the LSA+/Krone tool:

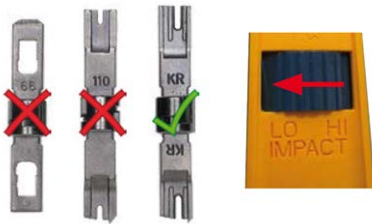

Fig. 12: LSA+/Krone tool set to LOW impact

CAUTION! Always use the proper LSA+/Krone blade and **set the tool to LOW impact.**

4. Connect the wires of the network cable using the LSA+/Krone tool according to the color code sticker inside the box:



Fig. 13: Network wires connected using LSA+/Krone tool

CAUTION! Remove all clipped wire ends to prevent short circuits.

Attach the Grounding Cable to the S74 Network Slide in Board with LSA terminal

WARNING! For surge protection it is strongly recommended to attach the ground wire!

Mounting

Installing Slide In Boards

The maximum length of the grounding cable should be 1m to the ground potential (e.g. a potential equalization rail, a grounded pole or a grounding rod).

1. Insert the ground wire into the white single-wire rubber plug:

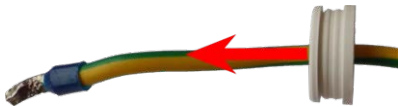

Fig. 14: Ground wire with single-wire rubber plug

2. Insert the ground wire into the opening of the board and make sure the rubber plug is properly seated all around the opening:
3. Loosen the screw of the ground wire terminal ① , insert the ground wire and properly fasten the screw of the terminal:



Fig. 15: Ground wire connected to terminal

Connect the S74 Network Slide in Board with LSA terminal with the camera

1. Position the interface board on the guide rails in the slide-in slot and push it in with slight pressure until it clicks into the socket. Then fix the board with the screw bolts ① .

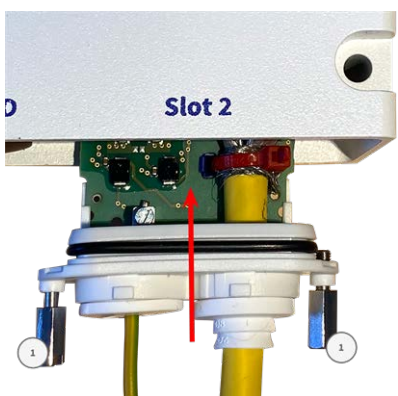

Fig. 16: Connecting the S74 Network Slide in Board with LSA terminal

CAUTION! Do not connect to the network at this stage!

Since the camera must not run without sensor modules, the network connection will be established only **after** mounting the camera and connecting the sensor modules.

Installing the S74 Network Slide in Board with RJ45 and VDC power supply

The S74 Network Slide in Board with RJ45 and VDC power supply is designed for powering the camera from an external power source and connecting it to the network. The board is not part of the scope of delivery (see [Scope of Delivery, p. 13](#)) and must be ordered in addition to the camera.



CAUTION! The S74 Network Slide in Board with RJ45 and VDC power supply may only be installed in slot 2 of the camera!

CAUTION! Do not connect to the network at this stage!

Since the camera must not run without sensor modules, the network connection will be established only **after** mounting the camera and connecting the sensor modules.

Procedure

1. **Remove cover from slot 2 of the camera:** Use a screwdriver to loosen both bolt screws ① and then pull out the plastic cover.
2. Insert the power cable into the white single-wire rubber plug.

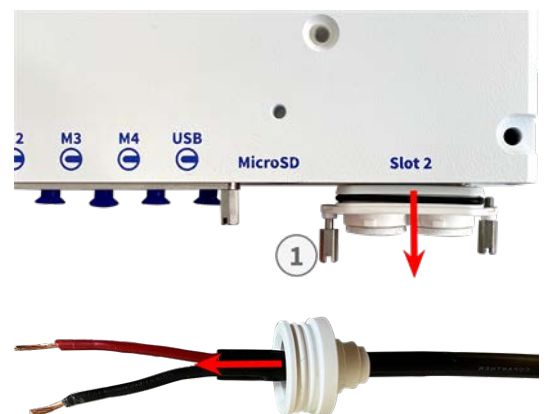

Mounting

Installing Slide In Boards

3. Insert the power cable into the opening of the board and make sure the rubber plug is properly seated all around the opening.
4. Loosen the screws of the power terminal ① , insert the wires of the cable and properly fasten the screws of the terminal.



CAUTION! Ensure the correct polarity!

5. Position the interface board on the guide rails in the slide-in slot and push it in with slight pressure until it clicks into the socket. Then fix the board with the screw bolts ① .

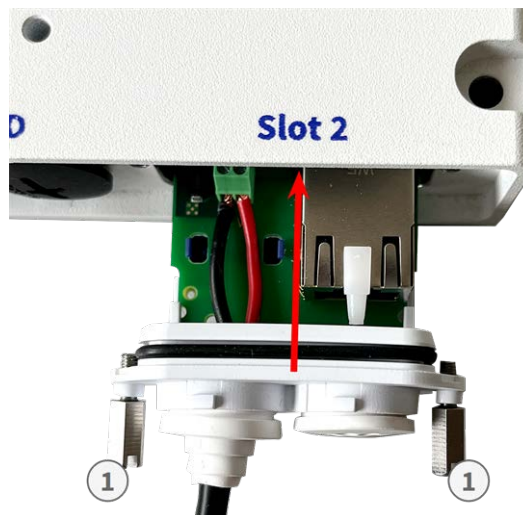

CAUTION! Do not connect to the network at this stage!

Since the camera must not run without sensor modules, the network connection will be established only **after** mounting the camera and connecting the sensor modules.

Installing the S74 IO Slide in Board

The S74 IO Slide in Board is designed for powering the camera from an external power source and connecting it to the network. The board is not part of the scope of delivery (see [Scope of Delivery, p. 13](#)) and must be ordered in addition to the camera.

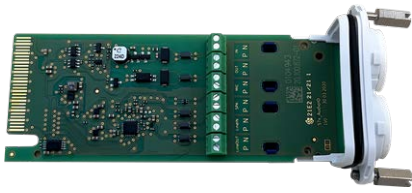

Fig. 17: S74 IO Slide in Board

CAUTION! The S74 IO Slide in Board may only be installed in slot 1 of the camera!

CAUTION! Do not connect to the network at this stage!

Since the camera must not run without sensor modules, the network connection will be established only **after** mounting the camera and connecting the sensor modules.

Procedure

1. **Remove cover from slot 1 of the camera:** Use a screwdriver to loosen both bolt screws ① and then pull out the plastic cover.



Fig. 18: Remove cover from interface board slot

Insert the I/O device cables into the white single-wire rubber plug:



2. Insert the I/O device cables into the opening of the board and make sure the rubber plug is properly seated all around the opening.

Mounting

Installing Slide In Boards

- Loosen the screws of the related I/O device terminal ① , insert the wires of the cable and properly fasten the screws of the terminal:

CAUTION! Ensure the correct polarity!

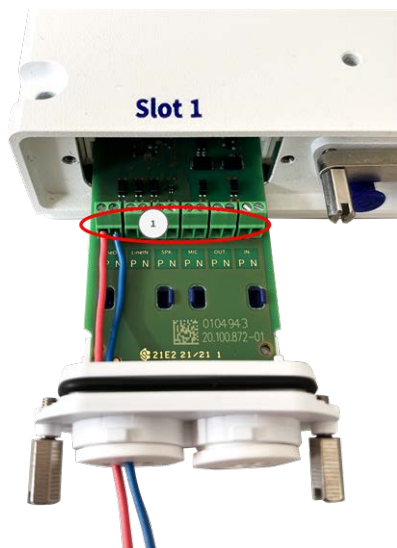

Fig. 19: IO wires connected to terminal

- Position the interface board on the guide rails in the slide-in slot and push it in with slight pressure until it clicks into the socket. Then fix the board with the screw bolts ① .

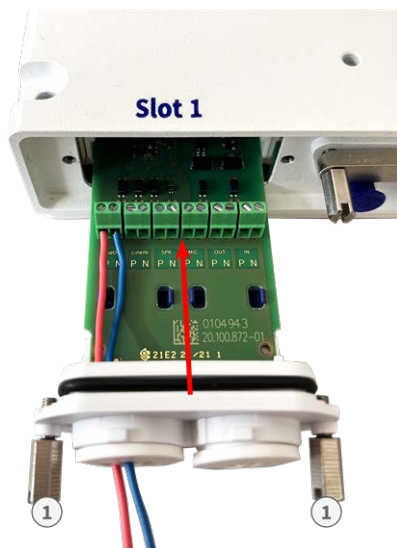

Fig. 20: Connecting the S74 Network Slide in Board with RJ45 socket

CAUTION! Do not connect to the network at this stage!

Since the camera must not run without sensor modules, the network connection will be established only **after** mounting the camera and connecting the sensor modules.

Terminal Connectors

All I/O connections to the camera can be made on the S74 IO Slide in Board which is not part of the part of scope of delivery of the camera.

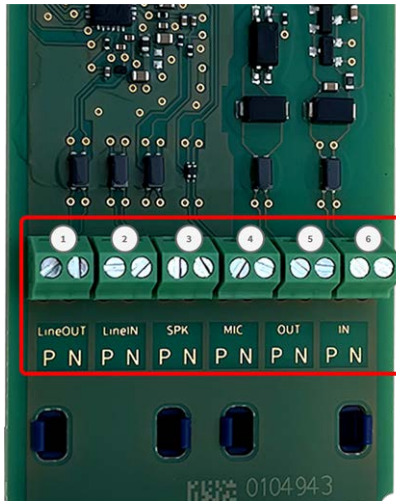

Allowed cable dimensions for cables connected to the PCB terminals

AWG	20 - 26
Rigid	0.14mm ² - 0.5mm ²
Flexible	0.14mm ² - 0.5mm ²
Flexible with ferrule	0.25mm ² - 0.34mm ²

Terminal	Remark
Line Out	Headphones with 20mW @ 16 Ohm or 32 Ohm. Audio inputs as a Line Out function to 10k Ohm impedance of receiver. Audio level while connected to 10k Ohm equals -10dbV
Line In	Standard Line In: (0dB) Vrms=1V
SPK	0,9W at any 8 Ohm speaker.
MIC	Passive microphone to connect (for best results). R_Bias for the microphone is 2.2 kOhm (included on the camera). Microphone impedance < 2.2 kOhm, Operating voltage of the microphone is 2V.

Mounting

Installing Slide In Boards

Terminal	Remark
IN	<ul style="list-style-type: none">▪ Contact Closure (no galvanic isolation necessary) or up to 50V AC/DC▪ max. length for cables: 50m
OUT	<ul style="list-style-type: none">▪ requires pull-up resistor and external power supply (10mA / max. 50V DC - no AC)▪ Output may be loaded with max. 50mA▪ max. length for cables: depends on loop impedance of the connected cable.

Example: switching an LED light using the P7 outputs

The outputs in the S74 Interface board are using an optocoupler with an open collector.

- The outputs will require the use of an external DC power supply up to 50 volts.
- The optimal output current of the optocoupler output is around 10mA.
- The maximum limit of the output current is 50mA.
- This must be maintained by an external pull-up resistor.

NOTE! They outputs are not capable of dry connect closure or direct use with AC power

The example shows a simple low voltage low current application such as switching an LED light using the P7 outputs.

The value of the pullup resistor depends on the forward voltage of the LED at the specific current you want to run through it.

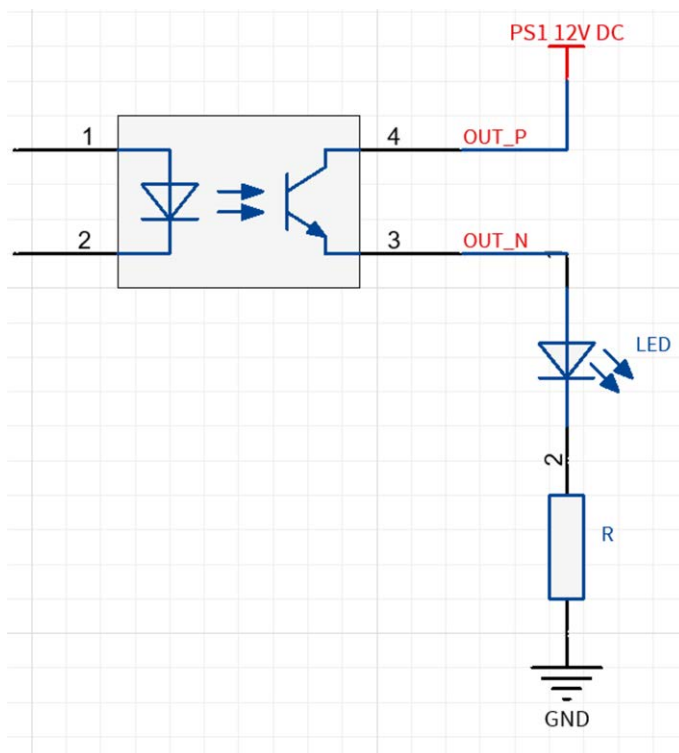

EXAMPLE:

- Amperage through LED: 10mA
- LED Forward Voltage @ 10mA: 2 V
- Power supply: 12V DC
- Resistor value = $(12V - 2V) / 10mA = 1\text{ k}\Omega$

NOTE! For further examples take a look at the MOBOTIX Online Community: <https://community.mobotix.com/>

Connecting the Audio Cable Mx-A-S7A-AUCBL05-AN

The cable is designed for connecting the MOBOTIX 7 Audio Module to the AudioIO of the S74 IO Slide in Board. The cable is not part of the scope of delivery (see [Scope of Delivery, p. 13](#)) and must be ordered in addition to the camera.



Fig. 21: Audio cable with two wire pairs

Connect the cable to the S74 IO Slide in Board (see [Installing the S74 IO Slide in Board, p. 58](#)) according to the following table:

Wire pair	Usage
blue/white twisted	Microphone
blue/red untwisted	Microphone
yellow/white twisted or untwisted	Speaker

Mounting the Camera

You can mount the S74 to any even surface.

Mounting

Mounting the Camera

Before mounting the MOBOTIX S74 and sensor modules, determine the ideal positions and make sure that the field of view is not obstructed in any way. Once the modules have been mounted, you can fine-tune the image. If the monitored area changes or the camera has to be installed in a different location, you can exchange the sensor modules.

Before mounting the camera, make sure that a network connection with power supply according to the PoE Plus (802.3at-2009) standard is available at the mounting position (see [Connecting the Camera to the Network](#), p. 67).

NOTE! Download the drilling template from the MOBOTIX website: www.mobotix.com > [Support](#) > [Download Center](#) > [Marketing & Documentation](#) > [Drilling Templates](#).

CAUTION! Always print or copy the drilling template at 100% of the original size!

NOTE! Do not use the dowels if the installation surface is wood. Only use the screws to fasten the mounting plate directly on the surface. In order to facilitate screwing in wood, the positions should first be pre-drilled using a 2 mm drill bit, for example (drilling depth just slightly less than screw length).

Step by Step

1. **Drill the holes:** Mark the holes for drilling using the drilling template (see [Drilling Template](#), p. 11). When drilling, use a 8 mm drill bit and drill holes with at least 60 mm/1.2" depth.
2. Fully push the dowels [M.5](#), p. 15 into the holes you drilled.
3. **Install the mounting plate:** Place the Camera over the drilled holes (1) and use the four screws [M.4](#), p. 15 with one washer [M.6](#), p. 15 each and the Phillips screwdriver to mount the plate to the wall.



CAUTION! Install on flat surface only.

Connecting Module Cables to the Camera

WARNING! Make sure the power supply to the camera is disconnected before installing or replacing sensor modules.

WARNING! When installing the sensor modules, make sure that the sensor module cables are not damaged or bent sharply!

Up to 4 sensor modules can be connected to the camera. Additionally an USB-C interface is available.



Fig. 22: 4 Module Connector Ports and 1 USB-C interface

Step by Step

1. Use a screwdriver to loosen both bolt screws ① and then pull of the module latch.

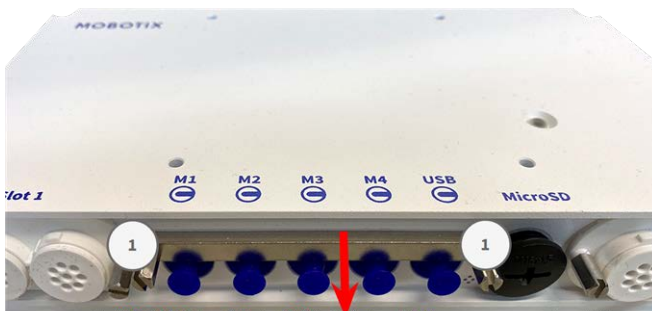

2. Remove the blue rubber plug ① from the module connector.

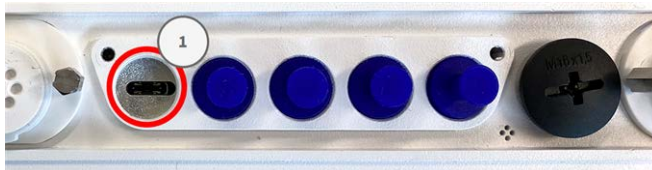

Mounting

Connecting Module Cables to the Camera

3. Plug the module cable into the module connector ① so that the small lug ② plug fits into the module connector.



CAUTION! If the module cable is not plugged in correctly, the sensor is not recognized by the camera.

4. Fasten the module latch by fastening the two bolt screws shown below.



5. Repeat steps 1 to 5 to connect additional modules.

Sensor Module Combinations

CAUTION!

- A maximum of two optical modules can be used.
- One thermal module can be used instead of one **optical** module.
- A maximum of two functional modules can be used.

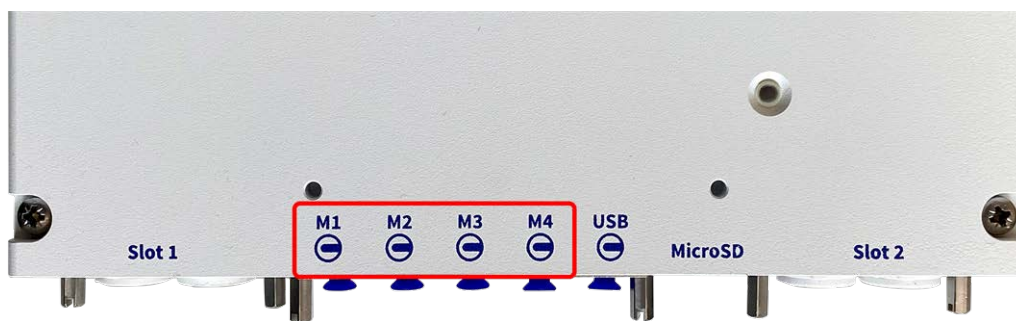

You can use the following combinations of sensor modules, thermal, and functional modules on the MOBOTIX S74:

Module	Module Connectors				Comments
	M1	M2	M3	M4	
Optical Sensor Modules					
all optical modules	yes	yes	no	no	
Thermal Sensor Modules					
all A -Variants	no	no	yes	no	e.g. Mx-O-M7SA-640R050
all B -Variants	yes	yes	yes	no	e.g. Mx-O-M7SB-640R050
IR & White Light Modules					
all IR & white light modules	yes	yes	yes	yes	
Other Functional Modules					
Mx-F-MSA	yes*	yes*	yes	yes*	MultiSense module * on M1 & M2 without noise detection
Mx-F-Audio	no	no	no	no	Speaker/Microphone; not applicable on MOBOTIX S74 use the S74 IO Slide in Board instead

Connecting the Camera to the Network

Network and power supply of the camera are established via an S74 Network Slide in Board with RJ45 socket (see [Installing the S74 Network Slide in Board with RJ45 socket, p. 51](#)) or an S74 Network Slide in Board with

Connecting the S74 Network Slide in Board with LSA terminal

1. Plug the network cable of the camera into a PoE network connector of the network switch.

Operating the Camera

This section contains the following information:

Getting Started	72
Boot Options of the Camera	73
Network Settings	75
Focusing the TELE 15° Sensor Module	79

Getting Started

You can use the MOBOTIX S74 with any current browser – or with MxManagementCenter.

You can download MxManagementCenter free-of-charge from www.mobotix.com > [Support](#) > [Download Center](#) > [Software Downloads](#).

1. **Connect the camera to the network.** The network cable will also provide power to the camera(see [Connecting the Camera to the Network](#), p. 67).
 1. **Establish a connection to the camera and adjust the network settings if required:** By factory default, MOBOTIX cameras are booting as DHCP client with an additional fixed IP address in the 10.x.x.x range (e.g., 10.16.0.128). Local computer networks usually have IP addresses in the 172 or 192 ranges. Depending on whether a DHCP server is present on the local network or if the network has been set up to use fixed IP addresses, there are several possibilities for establishing a connection to the camera and to change its [Network Settings](#), p. 75:
 - **Network with dynamic IP addresses**

Using a browser: If you know the IP address that the DHCP server assigned to the camera, simply enter that address in the browser address bar to directly connect to the camera

Using MxManagementCenter: With MxManagementCenter, you can show and integrate the camera without having to know its current IP address.
 - **Network with static IP addresses**

In order to access the camera, it must have an IP address within the range of the local network. To set the camera's network parameters, you can use one of these methods:

Manually using a web browser: You may have to adjust the network settings of your computer.
 - **Automatically using MxManagementCenter:** The camera is displayed in MxManagementCenter although the IP address is not part of the local network, allowing you to reconfigure its settings.
 2. **Configure camera:** You can use the user interface of the camera in a browser or in MxManagementCenter.

LED states

Camera LED on top of the camera body displays the following states by default:

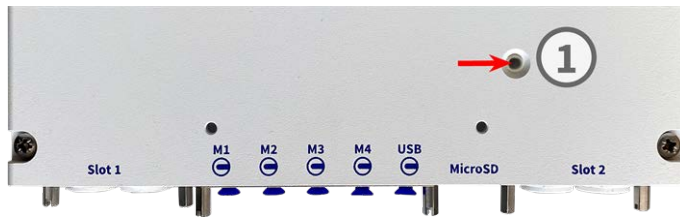

LED status	Meaning
green steady on	normal operation
green steady flashing	technical error or misconfiguration

Boot Options of the Camera

By default, the camera starts as DHCP client and automatically tries to get an IP address from a DHCP server. To start the camera in a mode different from the default mode, you can activate the boot menu of the camera.

NOTE! Pressing the key of the camera will let the camera announce the current IP address of the camera on the speaker (if a speaker is attached to the camera).

CAUTION! When opening the camera, do not insert any objects into the housing. This could damage the camera!

Prepare the camera

1. Disconnect the camera's power supply.
2. Remove the black cover screw ① with a screwdriver.



Using the boot menu

After establishing the power supply the red LED on top of the camera body lights up 5 to 10 seconds and will stay on for 10 seconds.

1. Take a suitable tool for operating the boot menu (e.g. the tweezers [M.3, p. 15](#)).
2. Reconnect the power supply of the camera.

Operating the Camera

Boot Options of the Camera

3. Press the key by inserting the tool into the hole ② . The camera enters the boot menu, ready for selecting one of the boot options. The LED will flash once. The flash signal will be repeated every second.



NOTE! The number of flashes corresponds to the current boot option.

4. **Switch the boot option:** Press the key (< 1 sec). After the last boot option, the camera returns to the first boot option (LED flashes once).

LED flashes	Boot Option	Meaning	Audio Confirmation*
1x	•/•	This option is not supported on this camera model.	•/•
2x	Factory Defaults	Starts the camera with factory defaults (factory default IP address, users and passwords will not be reset).	Boing
3x	Automatic IP Address	Starts the camera as DHCP client and tries to obtain an IP address from a DHCP server. If a DHCP server cannot be found or no IP address can be obtained, the camera starts with its factory default address.	Boing-Boing
4x	Recovery System	Starts the camera with the recovery system, e.g., in order to recover from a failed update of the camera software.	Alarm Sound

*Only on cameras with audio option and installed speaker.

5. **Select a boot option:** Press the key longer (> 2 sec). The camera confirms the selection by flashing the LED rapidly for 3 seconds. After 20 sec, the camera will play a sound according to the table above.

NOTE! If you do not select a boot option, the camera will resume its normal boot process after a certain time.

NOTE!

Starting the Camera With Factory Defaults or an Automatic IP Address (DHCP)

The configurations loaded when using the boot options 2 and 3 will not be automatically saved to the camera's flash memory. Upon starting the camera the next time, the camera will use the last configuration it stored. You can store the configuration in the camera's flash memory using the **Admin Menu > Store** command.

CAUTION!

Note that you can restore specific parts of the camera configuration afterward by using "Restore" to re-apply the settings still stored in the camera.

As opposed to resetting the camera using **Admin Menu > Reset configuration to factory defaults**, the user information will not be reset if the camera is booted using the factory defaults.

When starting the camera with DHCP support (option 2), make sure that the network has a properly functioning DHCP server. If this is not the case, the camera cannot obtain a valid IP address and will fall back to its last IP address.

You should also make sure that the cameras always get the same IP addresses by mapping the MAC addresses of the cameras to the desired IP addresses.

Network Settings

Once the camera has been connected to the network, you need to set up the MOBOTIX camera's network interface accordingly. This step involves setting up and checking the network parameters of the camera. If your network has an active DHCP server or if it is already running on a 10.x.x.x network with a 255.0.0.0 network mask) you do not need to change the camera's network parameters. You can directly access the camera. If neither your network nor your computer use an IP address in the 10.x.x.x network (e.g. a 192.168.x.x or 172.x.x.x network), you should follow one of the following methods for changing the camera's network parameters:

- Manual setup
- Automatic setup using MxManagementCenter

NOTE! For the following examples, we will use a camera with the factory IP address 10.16.0.99. Replace this IP address with the IP address of your camera. You will find this address on a small sticker on the camera. Make sure that the IP addresses used in the following examples are not used by any other devices on your network.

Windows

1. Open the Windows **Control Panel > Network and Internet > Network and Sharing Center > Change Adapter Settings > Ethernet.**

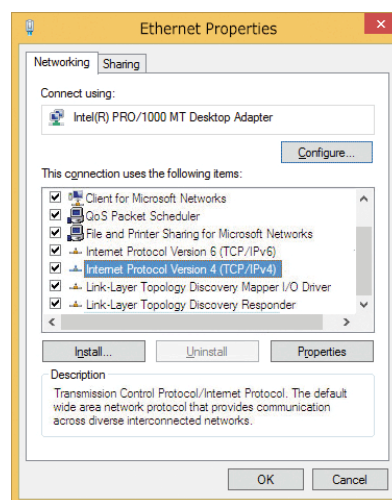

2. Right-click on the relevant network adapter and select **Properties.**
3. Open the properties of **Internet Protocol Version 4 (TCP/IPv4).**

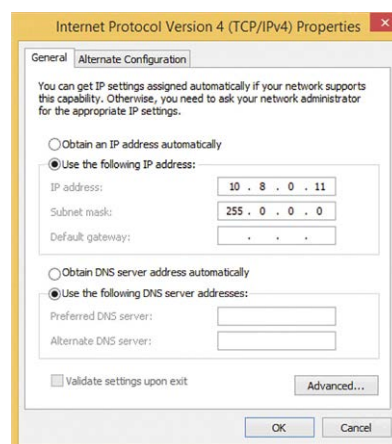

4. Activate **Use the following IP-address.** Enter an IP address in the 10.x.x.x range in this field (e.g. 10.16.0.11).
5. Click on **OK** to apply the settings.

Mac

1. Open **System Settings > Network**.



2. Click on **Ethernet** and in the **Configuration** field, select the *Manual* list entry and enter an IP address in the 10.x.x.x IP address range (e.g., 10.16.0.11).
3. Click on **Apply** to apply the settings.

Linux / Unix

1. Open a terminal as `root` user.
2. Enter the following command: `ifconfig eth0:1 10.16.0.11`.
3. The computer now has the additional IP address 10.16.0.11.

Network Settings on the Camera in the Webbrowser

1. Use a web browser to access the web interface of the MOBOTIX camera and enter the factory IP address (e.g. 10.16.0.99).

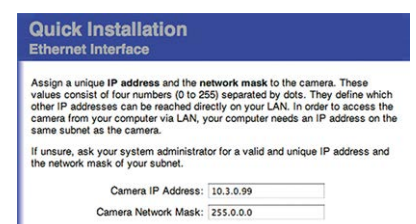

2. Click on the **Admin Menu** button in the user interface of the camera. The Quick Installation automatically starts after entering the access credentials of the admin user.

NOTE! Factory access credentials:

*User name:*admin

*Password:*meinsm

NOTE! You can also run the Quick Installation later on (**Admin Menu > Network Configuration > Quick Installation**; see Reference Manual).

3. Enter the network parameters of the camera in the course of the quick installation.

NOTE! You can also change the network parameters later on by running **Admin Menu > Network Configuration > Quick Installation**.

4. Reboot the camera to apply the network settings.

Network Settings on the Camera in MxMC

MxManagementCenter is a video management software for setting up and using the entire video surveillance system that provides a range of functions for different tasks and user groups. You can download the newest release of MxManagementCenter from the MOBOTIX website (www.mobotix.com > Support > Download Center > Software Downloads, MxManagementCenter section).

When starting MxManagementCenter for the first time, the configuration wizard opens and automatically starts searching for MOBOTIX cameras. The number of found cameras is shown as a counter next to the **Add Devices** icon. This number is updated automatically if the number of MOBOTIX cameras on the network has changed (i.e., by connecting new/disconnecting existing cameras).

1. Click on **Add Devices**. The cameras are displayed either in a list or as tiles. Use the List and Tile buttons to change the display mode.



The application automatically monitors and displays the operating status of all cameras using corresponding icons.

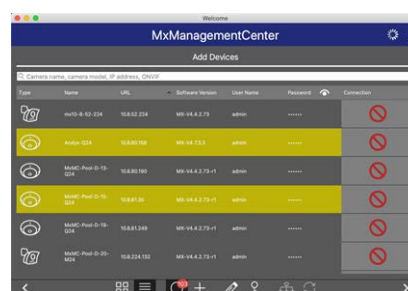

EXAMPLE:

- The camera is not in the same subnet as the computer.
- The user name and password of the camera are not known.

NOTE! Using the Bonjour service ([en.wikipedia.org/wiki/Bonjour_\(software\)](https://en.wikipedia.org/wiki/Bonjour_(software))), the application finds not only MOBOTIX cameras on the same subnet, but also in other subnets. Normally, you would not be able to establish any connection to cameras in a different network or subnet.

NOTE! This is the case, for example, if you are integrating cameras into a network without DHCP server (i.e. with fixed IP addresses) and the IP address range is different from the 10.x.x.x range supported by the cameras in addition to DHCP.

MxManagementCenter can automatically configure such a camera so that it is "integrated" into your existing network.

2. Select the camera you want to set up and click on **Edit Network Settings**  at the bottom of the program window. The **Change Network Settings for Selected Devices** dialog opens.



3. Enter the IP address and the subnet mask of the selected camera.

NOTE! The IP addresses of the other cameras are automatically incremented by 1.

4. Click on **Apply** to apply the settings.

NOTE! For more information on this feature, please read the MxManagementCenter online help or the Tutorial (see www.mobotix.com > Support > Download Center > Documentation > Brochures & Guides > Tutorials).

Focusing the TELE 15° Sensor Module

Once the camera has been mounted, the **TELE 15° sensor module** should be checked for proper sharpness. You will need the **lens wrench blue M.2** and the **module wrench gray M.1** that are part of the [Scope of Delivery of the MOBOTIX S74 Base Module](#).

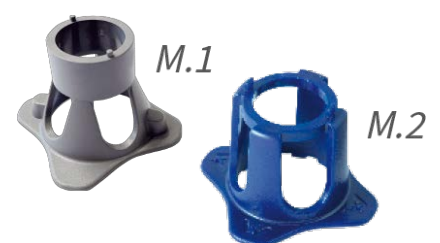

CAUTION! When adjusting the image focus or the field of view of the camera, always make sure that you can see the live image of the camera on your monitor.

To correct image sharpness, you can also make use of the visual **focusing aid** of the camera (see the **Camera Reference Manual**, section **The Live View of the MOBOTIX Camera**)

Operating the Camera

Focusing the TELE 15° Sensor Module

1. Show the live image of the camera on your monitor.
2. Insert the blue lens wrench into the notches of the sensor module.
3. Turn the wrench counter-clockwise until it stops



4. Rotate the wrench to the left until the lens protection glass slides out of the sensor module.
5. Insert the gray module wrench (with its two small pins) into the holes of the lens and cautiously turn to the left and to the right. Adjust the image sharpness according to the live image on the computer monitor:

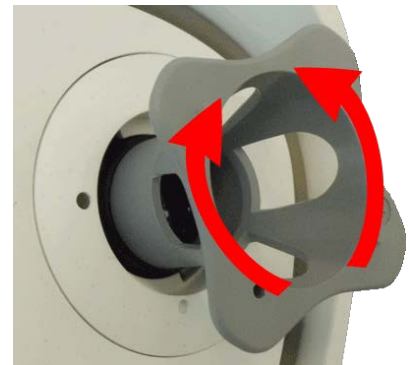

CAUTION! Never apply force when turning the lens and never screw the lens too deep into the thread since this could damage the image sensor! If in doubt, keep turning the lens counter-clockwise, then turn clockwise to focus the lens.

6. If required, clean the inside of the lens protection glass with a clean, lint-free cloth.



7. Set the lens protection glass onto the notches of the blue lens wrench and position the protection glass with its two prongs over the corresponding receptacles of the sensor module:

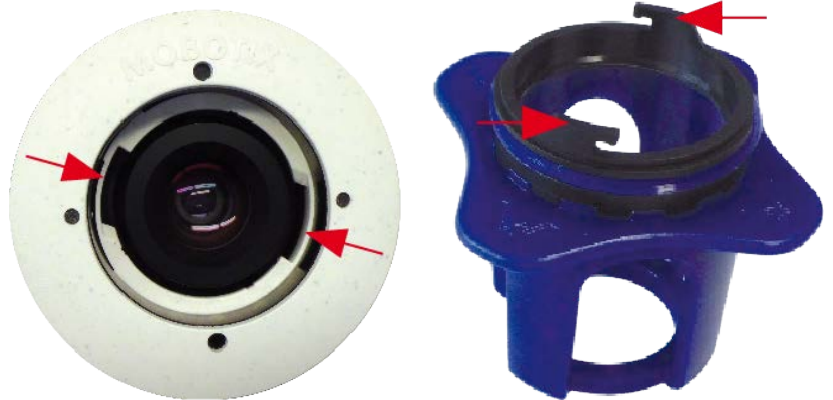

8. Using the lens wrench, press the lens protection glass firmly into the sensor module, until the glass fits flush with the sensor module housing.



9. Turn the lens protection glass clockwise using the blue lens wrench until it locks in place.
10. If required, clean the outside of the lens protection glass with a clean, lint-free cloth.

CAUTION! After adjusting the focus, make sure that the sensor module is aligned properly and that it is locked in place (use the gray module wrench to turn the sensor module clockwise until it stops).

Camera Software in the Browser

The integrated software of the MOBOTIX S74 features a multitude of functions, such as video motion detection, long-term recording, alarm messaging and video IP telephony. Especially remarkable are the AI-based analytics features and the possibility to install third-party apps on the camera. Thanks to the virtual PTZ features, you can continuously zoom into or out of the live image using either the mouse wheel or a joystick.

When recording images or video sequences, you can choose to store either the visible image area of the live image or the full sensor image. This also allows examining the parts of an image or video that had not been visible in the real-time image section on display at the time of the recording.

Instead of using a web browser, you can also download the free MxManagementCenter from the MOBOTIX website (www.mobotix.com > Support), which allows displaying multiple cameras on one monitor, allows for comfortably searching and evaluating the alarm video clips with audio and provides alerting features. For mobile iOS and Android devices, the free-of-charge MOBOTIX MOBOTIX LIVE App is available.

This section contains the following information:

Access the Camera in the Web Browser	84
Basic Settings	84
Configuring Sensor Modules	85

Access the Camera in the Web Browser

Once the power and network connection of the MOBOTIX have been established, you can access the interface of the camera software in a web browser.

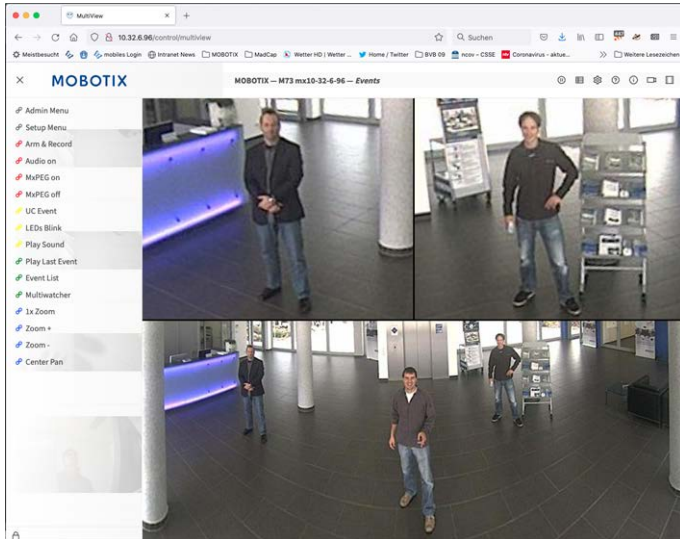

1. Enter the camera's IP address in the address field of a web browser.

NOTE! You can find the IP address of the camera, for example, in the camera housing or on the sticker on the packaging.

Basic Settings

Password for the Administration Menu: Accessing the administration area of the camera (Admin Menu button) in the browser is only possible after entering a user name and password.

- **Default user name:** admin
- **Default password:** meinsm

NOTE! You must change the password when logging in for the first time.

CAUTION! Make sure that you store information on user names and passwords in a secure place. If you lose the administrator password and cannot access the Administration menu, the password can only be reset at the factory. This service is subject to a service charge.

The Quick Installation wizard will appear automatically when accessing the Administration Menu for the first time. It provides an easy method to adjust the basic camera settings to the current application scenario. For

security reasons, it is highly recommended to change the default administrator password after the camera has been configured properly.

Administering the camera: You can modify the camera configuration in the Administration Menu or the Setup Menu:

- **Admin Menu:** This menu contains the basic configuration dialogs of the camera (e.g. passwords, interfaces, software update).
- **Setup Menu:** This menu contains the dialogs for configuring the image, event and recording parameters. Some of these settings can be changed using the corresponding Quick Controls in the Live screen.

NOTE! For more information, consult the Reference Manual of the camera.

Configuring Sensor Modules

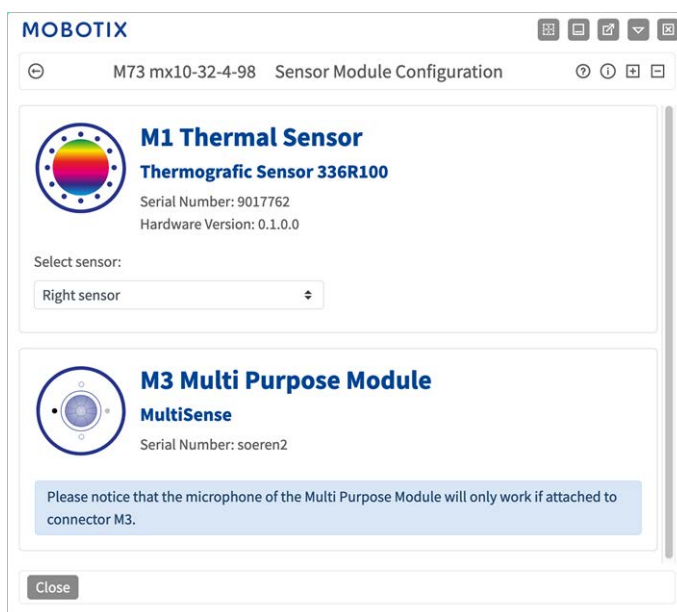

Using different combinations of sensor modules of the MOBOTIX S74 will have an influence on the display modes and configuration variants that are available.

An MOBOTIX S74 will automatically check and verify the installed sensor modules upon its first start and at every reboot thereafter (e.g., focal length, Day or Night variant). Please note the following:

- A Thermal Sensor Module , must be attached to connector **M1 (Thermal Sensor)**.
- If only one sensor module is attached, the camera will behave like a mono camera (i.e., there is no automatic Day/Night switching).

- If the modules are not exchanged within the first 12 operating hours, the camera will store the information of new sensor modules in the camera configuration.
- The camera will check the configuration on every reboot to see if the stored sensor modules are still present. If changes of the sensor module configuration have been detected (e.g., if a sensor module had to be replaced), the camera will show a corresponding message in the live image.

If required, the module configuration can be adjusted, e.g. you can define in which camera image (left or right) the sensor module should be displayed in a double image display.

1. Got to **Admin Menu > Hardware Configuration > Sensor Module Configuration**
2. Select the corresponding sensor module types

Do the **Sensor Module Configuration** in the following cases:

- **Switching the displayed camera images:** You want to show the left-hand camera image on the right (and vice versa), without having to physically swap the module connectors at the camera itself.
- **Exchanging sensor modules:** In this case, the MOBOTIX S74 will display a message box and will log a system message to inform you that sensor modules have been exchanged .
- **Adding/activating sensor modules:** You can activate modules that had been deactivated before.
- **Switching off/removing sensor modules:** If required, you can deactivate connected modules in this dialog.

For more information, consult the Reference Manual of the camera.

Maintenance

This section contains the following information:

Cleaning the Camera and Lenses	88
---	-----------

Cleaning the Camera and Lenses

Clean the camera housing using a mild alcohol-free detergent without abrasive particles.

To protect the lens protection glass, only use the supplied mounting supplies.

Cleaning the lens protection glass

- Use the wide end of the gray module wrench [M.1](#) to remove/install the lens protection glass. The narrow side of the wrench is used to adjust the sharpness (focal length) of the tele lenses.
- You should clean the lens protection glasses and domes regularly using a clean, lint-free cotton cloth. If the dirt is more persistent, add a mild alcohol-free detergent without abrasive particles.
- Make sure you instruct cleaning personnel on how to clean the camera.

MOBOTIX

BeyondHumanVision

[EN_07/24](#)

MOBOTIX AG • Kaiserstrasse • D-67722 Langmeil • Tel.: +49 6302 9816-103 • sales@mobotix.com • www.mobotix.com

MOBOTIX is a trademark of MOBOTIX AG registered in the European Union, the U.S.A., and in other countries. Subject to change without notice. MOBOTIX do not assume any liability for technical or editorial errors or omissions contained herein. All rights reserved. © MOBOTIX AG 2020