



Technical Specifications

MOBOTIX MOVE 20MP Multisensor IR Video Analytics Camera

The MOBOTIX MOVE 20MP Multisensor IR Video Analytics Camera incorporates four individually adjustable 5MP sensors with remote zoom/focus lenses for optimum positioning and alignment to the observation needs. Four individual video streams plus a combined stream of all four sensors that provides an undistorted view up to 360 degrees make this camera the best choice for monitoring large areas or road intersections. The integrated DNN-based video analytics features include Face and License Plate recognition for 24/7 video surveillance with simultaneous detection of multiple objects. The MOBOTIX EverClear superhydrophilic and self-cleaning nano coating of the multisensor bubble ensures best image quality even in rain and reduces cleaning efforts and operational costs.

- 4 x 5MP image sensors, freely adjustable (1/2.8" Progressive CMOS IMX 675 SONY STARVIS II)
- High light sensitivity: 0.02 Lux color, 0.001 Lux B/W
- Motorized 3x zoom/focus lens 2.8 to 8 mm
- WDR up to 130 dB
- Integrated IR surround illumination up to 30 m/100 ft
- Supports up to nine streams H.264/H.265/MJPEG
- Smart event functions
- Intelligent encoding, smart low-bitrate control
- Integrated microphone and speaker, bi-directional audio Line In/Out
- MOBOTIX MxMessageSystem
- 2D & 3D motion-compensated noise reduction (MCTF)
- ONVIF Profile S/G/T/M support
- DNN video analytics (8 VA, Face & ALPR)
- M.2 SATA3 SSD support up to 8 TB
- microSD SDHC/SDXC card support up to 1 TB (2 slots)
- Triple power support (IEEE802.3bt/AC24V/DC24V)
- Protection class IP66/IK10
- NEMA 4x-compliant
- Built-in FIPS 140-2 Level 2-certified TPM hardware/firmware
- Temp. Range -40 to 60 °C/-40 to 140 °F with heater
- EverClear coating of multisensor bubble



BeyondHumanVision

MOBOTIX MOVE

Technical Specifications

MOBOTIX MOVE 20MP Multisensor IR Video Analytics Camera

High-Quality DNN Edge Video Analytics



The latest computer vision technology makes the DNN-accelerated video processing engine efficient at the edge. This integrated engine provides high accuracy, and 10 (DNN-based) video analytics functions including ALPR and human face recognition. Moreover, it allows simultaneous detection on multiple objects.

MOBOTIX EverClear Nano Coating

The new, groundbreaking MOBOTIX EverClear coating uses a special nano technology that transforms water droplets into an ultra-thin water film immediately upon impact. This ensures the highest image quality in rain and difficult environmental conditions and reduces maintenance costs due to its “self-cleaning” effect.



Freely Positionable Image Modules

The four sensor modules can be arranged next to each other as required and thus optimally aligned to the detection area.

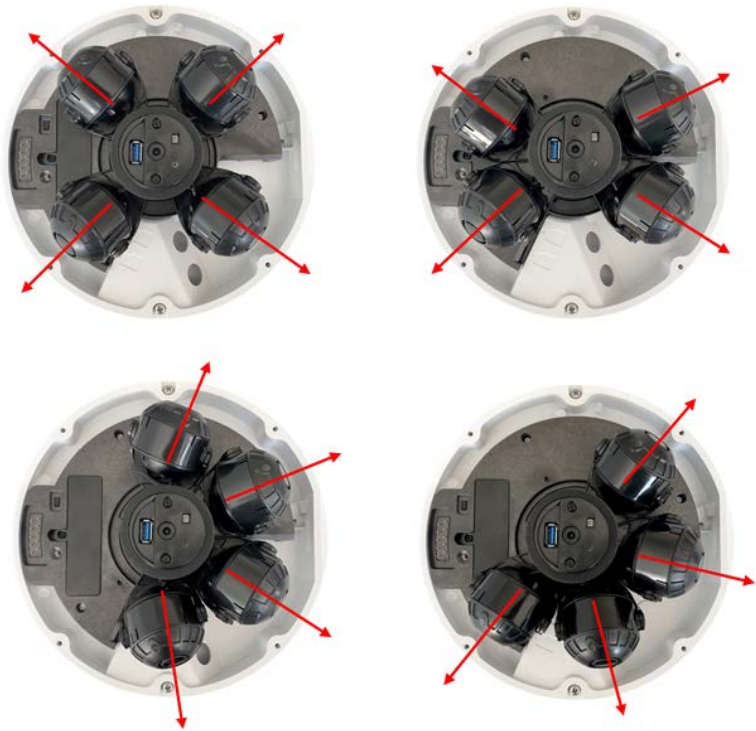

Every sensor module can be tilted by up to 95 degrees. In addition, you can pivot every module by ± 20 degrees.

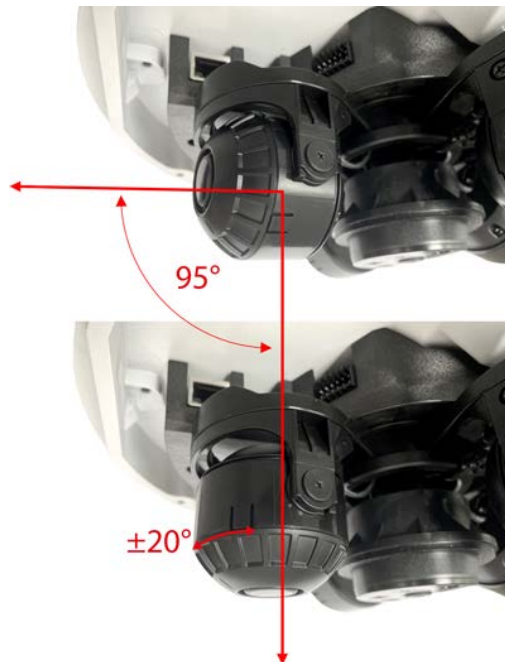

Product Information

Product Name	20MP Multisensor IR Video Analytics Camera
Order Code	Mx-VM1A-20-IR-VA

Technical Specifications

MOBOTIX MOVE 20MP Multisensor IR Video Analytics Camera

Hardware Design

Processor	Ambarella CV52 (Dual-core ARM® Cortex®-A76, 1.6 GHz)
Memory	RAM: 512 MBytes FLASH: 256 MBytes
Image Sensors	4 x 5MP 1/2.8" Progressive CMOS IMX675 (SONY STARVIS 2)
Effective (Used) Pixels (per image sensor)	2608x1964 (5MP)
Pixel Size	2.0 µm

Lens

Minimum Illumination	Color: 0.02 Lux B/W: 0.001 Lux F1.6, AGC=on, 30 IRE, 1/1 s
Lens Characteristics (per image sensor)	Motorized Lens: Zoom, Focus Focal Length: 2.8 to 8 mm Aperture: F1.6 Horizontal Field of View: 111.5° (Wide), 53.7° (Tele) Vertical Field of View: 79° (Wide), 40.2° (Tele)
Multisensor Bubble Coating	Superhydrophilic MOBOTIX EverClear nano coating transforms water droplets into an ultra-thin water film upon impact. The coating ensures best image quality in rain and difficult external conditions and it reduces reflections and noise in low-light scenarios. EverClear is dirt-repellent and increases the stability as well as the scratch-resistance of the multisensor bubble, further reducing maintenance efforts. Coating endurance up to 3 years depending on environmental conditions and cleaning treatment.

Camera

Day/Night	Automatically switchable IR-cut filter
Shutter Speed (Auto)	1 to 1/10000 s

Technical Specifications

MOBOTIX MOVE 20MP Multisensor IR Video Analytics Camera

Shutter Speed (Manual)	WDR: 1 to 1/67500 s Linear: 1 to 1/67500 s
Shutter Priority Mode	Up to 1/45 s
Frame Rate (maximum)	WDR on/off: H.265/H.264: 5MP@30 fps MJPEG: 1080p@30 fps
Auto Gain	Min. gain: 3 dB, max. gain: 48 dB, step size: 3
WDR	Up to 130 dB
Zoom	Optical: 3x, Digital: 10x
Image Settings	Color, Brightness, Sharpness, Contrast, White Balance, Exposure Control, 2DNR, 3DNR, NR by Motion, Masking, Text Overlay
Image Rotation	90°, 180°, 270°
Camera Module Adjustment (per image sensor)	Pan/tilt/rotate/twist

Video Codec

Compression/Encoding	H.265/H.264/MJPEG
Streaming	Up to 9 individually configurable streams (4 streams, 4 sub streams, 1 Quad stream) in H.264/H.265/MJPEG; configurable resolution, frame rate, bandwidth LBR/VBR/CBR in H.265/H.264

Audio Codec

Compression/Encoding	G.711/G.726/AAC/LPCM
Streaming	Bi-directional

Technical Specifications

MOBOTIX MOVE 20MP Multisensor IR Video Analytics Camera

Audio Input	Integrated microphone and speaker Line In: <ul style="list-style-type: none">▪ Max. 2.28 V_{pp} for line signal▪ Input impedance: 33 kΩ
Audio Output	Line Out <ul style="list-style-type: none">▪ Output resistance: 220 Ω▪ Output voltage: 1 V_{rms}

Cyber Security Features

Password Protection	Yes (including “forced” password change during initial setup)
IP address filtering	Yes (to restrict unauthorized access based on IP addresses)
IEEE 802.1X network access control	Yes (for advanced network security and authentication)
Digest authentication	Yes (for secure user authentication)
FIPS 140-2 Level 2	Yes (Infineon OPTIGA™ TPM SLB 9670 TPM 2.0, NIST/CMVP Certified Trusted Platform Module: Certificate #3492) Security Level Exceptions: <ul style="list-style-type: none">▪ Physical Security: Level 3▪ EMI/EMC: Level 3
Secure Boot	Yes (support of fixed IP setting and automatic DHCP IP configuration according to individual MAC address)
True random number generator	Yes (via TPM chipset)
AES encryption for password protection	Yes (to ensure strong encryption for password storage)
HTTPS/SSL (using TLS)	Yes (TLS 1.2 default, TLS 1.0/1.1 optional selectable)
User and Group Management	Yes (for fine-grained access control)
VPN	Yes (to establish secure network connections)

Digitally signed firmware	Yes (to prevent firmware file tampering)
RSA encryption	Yes (to support stronger ciphers; supported: RSA (2048 bits), AES-128, AES-256, SHA-256, SHA-384)

Network

Interface	10/100/1000 Mbps Ethernet
Supported Protocols	ARP, PPPoE, IPv4/v6, ICMP, IGMP, QoS, TCP, UDP, DHCP, UPnP, SNMP, SMTP, RTP, RTSP, HTTP, HTTPS, FTP, NTP, DDNS, SMBv2, VPN
ONVIF conformance	Supports profiles S/G/T/M
Supported Browsers	All current browsers are supported.

System Integration

Base Video Analytics	<ul style="list-style-type: none">▪ Motion detection▪ Audio detection
Enhanced Video Analytics	<ul style="list-style-type: none">▪ Abandoned objects▪ Intrusion (object classification)▪ Sabotage▪ Wrong direction▪ Loitering (object classification)▪ Object counting (object classification)▪ Object removal▪ Stopped vehicle (object classification) <p>1 analytics function can be activated for every image sensor</p>

Technical Specifications

MOBOTIX MOVE 20MP Multisensor IR Video Analytics Camera

DNN (Deep Neural Network) based video analytics

- Face Recognition (incl. gender & age estimation)
- Number Plate Recognition – supported countries: Armenia, Austria, Azerbaijan, Belarus, Belgium, Bosnia and Herzegovina, Bulgaria, Croatia, Cyprus, Czech Republic, Denmark, Estonia, Finland, France, Georgia, Germany, Greece, Hungary, Ireland, Israel, Italy, Japan, Kazakhstan, Kyrgyzstan, Latvia, Lithuania, Luxembourg, Moldova, Monaco, Montenegro, Netherlands, North Macedonia, Norway, Poland, Portugal, Romania, Russia, Serbia, Slovakia, Slovenia, Spain, Sweden, Switzerland, Taiwan, Turkey, Ukraine, United Kingdom, Uzbekistan, Vietnam

Event Triggers

- External input
- Analytics
- Network failure detection
- Periodical event
- Manual trigger
- MxMessageSystem messages

Event Actions

- External output activation
- Video and audio recording to edge storage
- File upload: FTP, network share and email
- Notification: HTTP, FTP, email
- MxMessageSystem messages

General

Housing Materials

Metal and plastic

Housing Color

RAL 9003

Power Requirements

IEEE802.3bt, Type 3, class 6, max 51 Watt

AC24V, max 53.1 Watt, max 74.8 VA

DC24V, max 27.55 Watt

MOBOTIX MOVE 20MP Multisensor IR Video Analytics Camera

- Connectors
- RJ45 (Ethernet)
 - USB Type A
 - 2 x Alarm in, 2x Alarm out, Audio in, Audio out terminal block
 - DC24V/AC24V terminal block
 - Line In/Out

IR Illumination 850 nm; up to 30 m/100 ft distance depending on scenery reflection

Video Storage microSD SDHC/SDXC card support up to 1 TB (2 slots),
M.2 SATA3 SSD card support up to 8 TB (**NO SCSI support!**),
support for recording to NAS, MOBOTIX HUB, MOBOTIX MOVE NVR, MOBOTIX CLOUD

Remotely Upgradable Firm-ware Yes

Environmental Protection Class IP66/IK10

Operating Temperature -40 to 60 °C/-40 to 140 °F with heater

Relative Humidity 90 % non-condensing

Storage Conditions -20 to 70 °C/-4 to 158 °F

Approvals
EMC: CE/FCC
Safety: LVD
IT Security: FIPS 140-2-compliant (using certified TPM chipset)
Environmental: IP66, IK10, NEMA-4x-compliant

MTBF 95,000 hours

Warranty 5 years; mechanically wearable parts (motor, gears, belts, etc.) excluded

Dimensions ø 255 x 105 mm

Weight 2400 g

NOTE! Observe the [MOBOTIX MOVE Installation Hints](#) document to ensure optimum performance of the camera features.

Technical Specifications

MOBOTIX MOVE 20MP Multisensor IR Video Analytics Camera

Alarm Input/Output Current and Voltage

Alarm In	Alarm Out
5 V with 10 k Ω pull up, 50 mA	400 V DC/AC, 120 mA







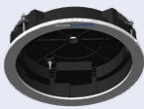

DORI Specifications

In the video surveillance context, “DORI” stands for Detection, Observation, Recognition and Identification and is based on IEC EN62676-4: 2015. These levels define the minimum pixels that a face of a person must have to provide proper identification, for example.





- **Detection:** Up to this distance, you can reliably determine if a person or vehicle is present.
- **Observation:** Up to this distance, you can see characteristic details of an individual, such as distinctive clothing.
- **Recognition:** Up to this distance, you can determine with a high degree of certainty whether an individual is the same as someone that has been seen before.
- **Identification:** Up to this distance, you can determine the identity of an individual beyond reasonable doubt.

DORI Level	Detection		Observation		Recognition		Identification	
	Wide	Tele	Wide	Tele	Wide	Tele	Wide	Tele
Mx-VM1A-20-IR-VA	53 m/ 174 ft	109 m/ 358 ft	21 m/ 69 ft	43 m/ 141 ft	11 m/ 36 ft	22 m/ 72 ft	5 m/ 16 ft	11 m/ 36 ft

Accessories

Picture	Order Code	Description
	Mx-M-VM-IC	Ceiling Flush Mount for 20MP Multisensor IR Video Analytics Camera
	Mx-M-VM-AP	Adapter Mounting Plate for (use with Mx-M-SD-GN, Mx-M-SD-PM/PMEXT, Mx-M-SD-W, Mx-M-SD-WM)
	Mx-A-VM-DBC	Clear Replacement Dome for 20MP Multisensor IR Video Analytics Camera
	Mx-A-VM-DBT	Tinted Replacement Dome for 20MP Multisensor IR Video Analytics Camera
	Mx-M-SD-C	Corner Mount
	Mx-M-SD-GN	Parapet Mount (Gooseneck) with integrated junction box
	Mx-M-SD-P	Pole Mount
	Mx-M-SD-PM	Pendant Mount Kit 25 cm
	Mx-M-SD-PMEXT	Pendant mount extension 25 cm for use with Pendant Mount Kit Mx-M-SD-PM

MOBOTIX MOVE 20MP Multisensor IR Video Analytics Camera

Picture	Order Code	Description
	Mx-M-SD-W	Wall Mount; can be combined with Pole Mount Mx-M-SD-P or Corner Mount Mx-M-SD-C
	Mx-M-SD-WM	Wall Mount with room for optional junction box
	Mx-M-SD-WMJB	Wall Mount Junction Box
	Mx-NPA-PoE1A-60W-BT	Network Power Injector 60 W
	Mx-A-ETP1A-2601-SET	Media Converter Set Ethernet (PoE+) – Twisted-Pair

Dimensions

NOTE! Download the drilling template from the section or on the MOBOTIX website: www.mobotix.com > [Support](#) > [Download Center](#) > [Marketing & Documentation](#) > [Drilling Templates](#).

CAUTION! Always print or copy the drilling template at 100% of the original size!

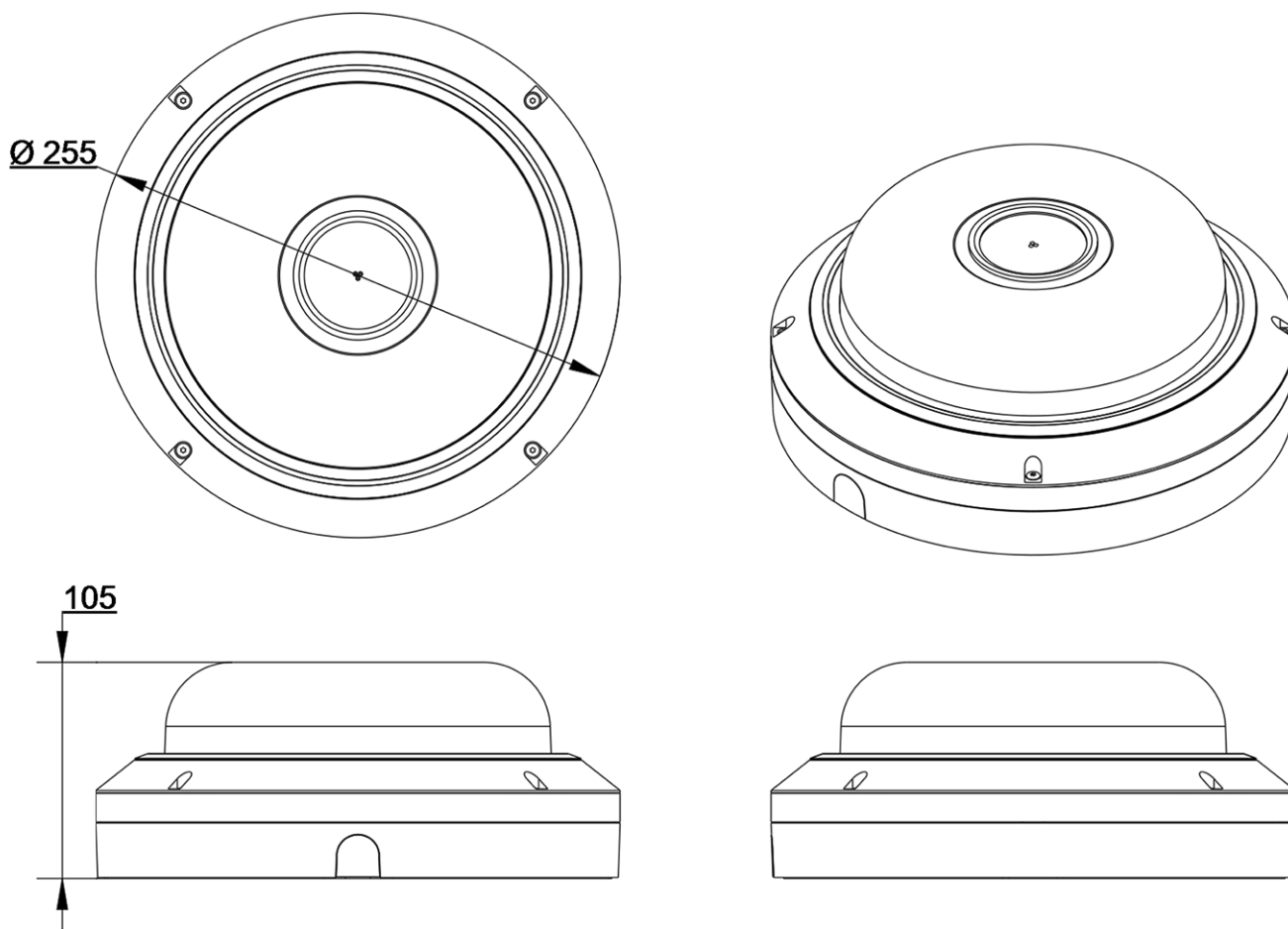

Fig. 1: 20MP Multisensor IR Video Analytics Camera: All measurements in mm

Further Reading

[Manuals and Quick Installation documents](#)



[Video Analytics Manual](#)



[Technical Specifications](#)



[MOBOTIX MOVE Installation Hints](#)



[MOBOTIX Community](#)



MOBOTIX

BeyondHumanVision

EN_05/24

MOBOTIX AG • Kaiserstrasse • D-67722 Langmeil • Tel.: +49 6302 9816-103 • sales@mobotix.com • www.mobotix.com

MOBOTIX is a trademark of MOBOTIX AG registered in the European Union, the U.S.A., and in other countries. Subject to change without notice. MOBOTIX do not assume any liability for technical or editorial errors or omissions contained herein. All rights reserved. © MOBOTIX AG 2020