



# Technical Specifications

## MOBOTIX MOVE 2MP Vandal Fixed Dome Analytics Camera

Performant 2MP, full HD 1080p resolution camera with integrated Video Analytics features, perfect for the daily security and surveillance needs. The camera performs fast and reliable auto focus and adapts to different indoor and outdoor scenes. The MOBOTIX EverClear superhydrophilic and self-cleaning nano coating of the dome ensures best image quality even in rain and reduces cleaning efforts and operational costs.

- EverClear coating of dome
- Motorized Vari-Focal Lens 2.7 to 12 mm, F1.6 to F2.9 with Zoom and One-Push Auto Focus
- Wide Dynamic Range (WDR) max. 130 dB
- MOBOTIX MxMessageSystem communication system
- Integrated Video Analytics
- Integrated IR LEDs up to 40 m/131 ft Distance
- ONVIF Profile S/G/T/M support
- Triple power support (IEEE802.3af/AC24V/DC12V)
- Temperature Range -55 to 60 °C/-67 to 140 °F
- IP66 and IK10
- Quick Connection Mount



BeyondHumanVision

MOBOTIX MOVE

## Technical Specifications

### MOBOTIX MOVE 2MP Vandal Fixed Dome Analytics Camera

#### High-Quality Edge Video Analytics

Counting	Intrusion	Removed Objects	Sabotage
			
Abandoned Objects	Stopped Vehicle	Wrong Direction	Loitering
			

The latest computer vision technology makes the video processing engine efficient at the edge. This integrated engine provides high accuracy, and 8 video analytics functions. Moreover, it allows simultaneous detection on multiple objects.

#### MOBOTIX EverClear Nano Coating

The new, groundbreaking MOBOTIX EverClear coating uses a special nano technology that transforms water droplets into an ultra-thin water film immediately upon impact. This ensures the highest image quality in rain and difficult environmental conditions and reduces maintenance costs due to its “self-cleaning” effect.



## Product Information

Product Name	2MP Vandal Fixed Dome Analytics Camera
Order Code	Mx-VD3A-2-IR-VA

## Hardware Design

Processor	Ambarella S6L22m (Quad-core ARM® Cortex®-A53, 600 MHz)
Memory	RAM: 512 MBytes FLASH: 256 MBytes

## Technical Specifications

### MOBOTIX MOVE 2MP Vandal Fixed Dome Analytics Camera

---

Image Sensor	5MP, 1/2.7" Progressive CMOS OS05A20 (OmniVision)
Effective (Used) Pixels	1920x1080 (2MP)

---

#### Lens

Minimum Illumination	Color: 0.08 lux B/W: 0.008 lux
Lens Characteristics	Motorized Lens: Zoom, Focus, P-IRIS Focal Length: 2.7 to 12 mm Aperture: F1.6 to F2.9 Horizontal Field of View: 99.4° (Wide), 31.3° (Tele) Vertical Field of View: 53.1° (Wide), 17.7° (Tele)
Lens Mechanics	3-Axis adjustment
Dome Coating	Superhydrophilic MOBOTIX EverClear nano coating transforms water droplets into an ultra-thin water film upon impact. The coating ensures best image quality in rain and difficult external conditions and it reduces reflections and noise in low-light scenarios. EverClear is dirt-repellent and increases the stability as well as the scratch-resistance of the dome, further reducing maintenance efforts. Coating endurance up to 3 years depending on environmental conditions and cleaning treatment.

---

#### Camera

Day/Night	Automatic mechanically switchable IR-cut filter
Shutter Speed	<b>Manual Mode:</b> WDR: up to 1/17550 s Linear: up to 1/37440 s <b>Automatic Mode:</b> Up to 1/10000 s
Frame Rate (maximum)	H.265/H.264: 1920x1080@30 fps + 720x480@30fps MJPEG: 1080p@30fps
Auto Gain	Min. gain: 3 dB, max. gain: 48 dB, step size: 3

---

## Technical Specifications

### MOBOTIX MOVE 2MP Vandal Fixed Dome Analytics Camera

---

WDR	Up to 130 dB Multi Exposure WDR & HDR Engine support
Zoom	Optical: 4.4x, Digital: 10x
Image settings	Color, Brightness, Sharpness, Contrast, White Balance, Exposure Control, 2DNR, 3DNR, NR by Motion, Masking, Text Overlay
Corridor Mode	90°, 180°, 270° Rotation

---

## Video Codec

Compression/Encoding	H.265/H.264/MJPEG
Streaming	Up to 4 individually configurable streams in H.264/H.265/MJPEG; configurable resolution, frame rate, bandwidth LBR/VBR/CBR in H.265/H.264.

---

## Audio Codec

Compression/Encoding	G.711/G.726/AAC/LPCM
Streaming	2-Way, bidirectional
Audio Input	Line In: Max 6.2 Vpp Signal In, Input Impedance: 33 k $\Omega$
Audio Output	Line Out: 1 Vrms Signal Out, Output Resistance: 200 $\Omega$

---

## Cyber Security Features

Password Protection	Yes (including “forced” password change during initial setup)
IP address filtering	Yes (to restrict unauthorized access based on IP addresses)
IEEE 802.1X network access control	Yes (for advanced network security and authentication)
Digest authentication	Yes (for secure user authentication)
Secure Boot	Yes (support of fixed IP setting and automatic DHCP IP configuration according to individual MAC address)
AES encryption for password protection	Yes (to ensure strong encryption for password storage)
HTTPS/SSL (using TLS)	Yes (TLS 1.2 default, TLS 1.0/1.1 optional selectable)

---

## Technical Specifications

### MOBOTIX MOVE 2MP Vandal Fixed Dome Analytics Camera

---

User and Group Management	Yes (for fine-grained access control)
VPN	Yes (to establish secure network connections)
Digitally signed firmware	Yes (to prevent firmware file tampering)
RSA encryption	Yes (to support stronger ciphers; supported: RSA (2048 bits), AES-128, AES-256, SHA-256, SHA-384)

---

## Network

Interface	10/100 Mbps Ethernet
Supported Protocols	ARP, PPPoE, IPv4/v6, ICMP, IGMP, QoS, TCP, UDP, DHCP, UPnP, SNMP, SMTP, RTP, RTSP, HTTP, HTTPS, FTP, NTP, DDNS, SMBv2
ONVIF conformance	Supports profiles S/G/T/M
Supported Browsers	All current browsers are supported.

---

## System Integration

Base Video Analytics	<ul style="list-style-type: none"><li>▪ Motion detection</li><li>▪ Audio detection</li></ul>
Enhanced Video Analytics	<ul style="list-style-type: none"><li>▪ Abandoned objects</li><li>▪ Intrusion</li><li>▪ Sabotage</li><li>▪ Wrong direction</li><li>▪ Loitering</li><li>▪ Object counting</li><li>▪ Object removal</li><li>▪ Stopped vehicle</li></ul>

2 analytics functions can be activated simultaneously

---

## Technical Specifications

### MOBOTIX MOVE 2MP Vandal Fixed Dome Analytics Camera

---

Event Triggers	<ul style="list-style-type: none"><li>▪ External input</li><li>▪ Analytics</li><li>▪ Network failure detection</li><li>▪ Periodical event</li><li>▪ Manual trigger</li><li>▪ MxMessageSystem messages</li></ul>
Event Actions	<ul style="list-style-type: none"><li>▪ External output activation</li><li>▪ Video and audio recording to edge storage</li><li>▪ File upload: FTP, network share and email</li><li>▪ Notification: HTTP, FTP, email</li><li>▪ MxMessageSystem messages</li></ul>

---

## General

Housing Materials	Metal Housing
Housing Color	RAL 9003
Camera Module Adjustment	3-Axis Gimbal (Pan/Tilt/Rotate)
Device Color	Metal body housing: RAL 9003 Logo color: Pantone 286C and Pantone Gray 6 Cu
Power Requirements	PoE IEEE802.3af, class 0, max 12.95 W DC12V, max 14.88 W AC24V, max 15.25 W, max 26.16 VA Zero-Down-Time Power Source Switching
PoE Modes Supported	Mode A or Mode B
Connectors	RJ45, Alarm in x2, Alarm out x1, Audio in, Audio out terminal block, DC12V/AC24V terminal block, CVBS Connector COAX (75 Ohm) (CVBS output available with max. 2 activated streams, requires optional adapter 2-pin COAX cable)
IR Illumination	Up to 40 m/131 ft distance depending on scenery reflection

---

## Technical Specifications

### MOBOTIX MOVE 2MP Vandal Fixed Dome Analytics Camera

Video Storage	Micro SD/SDHC/SDXC card support up to 1 TB, Support for recording to NAS, MOBOTIX HUB, MOBOTIX MOVE NVR
Environmental Protection Class	IP66 and IK10
Operating Temperature	-55 to 60 °C/-67 to 140 °F
Cold Start Temperature	-30 °C/-22 °F
Relative Humidity	90 % non-condensing
Storage Conditions	-20 to 70 °C/-4 to 158 °F
Approvals	EMC: CE/FCC Safety: LVD Environmental: IP66, IK10
MTBF	95,000 hours
Warranty	5 years
Dimensions	ø 133.8 x 117.4 mm
Weight	760 g

**NOTE!** Observe the [MOBOTIX MOVE Installation Hints](#) document to ensure optimum performance of the camera features.

## Alarm Input/Output Current and Voltage

### Alarm In

3.3 V with 10 kΩ pull up, 50 mA

### Alarm Out

350 V DC/AC, 130 mA

# DORI Specifications







In the video surveillance context, “DORI” stands for Detection, Observation, Recognition and Identification and is based on IEC EN62676-4: 2015. These levels define the minimum pixels that a face of a person must have to provide proper identification, for example.

- **Detection:** Up to this distance, you can reliably determine if a person or vehicle is present.
- **Observation:** Up to this distance, you can see characteristic details of an individual, such as distinctive clothing.
- **Recognition:** Up to this distance, you can determine with a high degree of certainty whether an individual is the same as someone that has been seen before.
- **Identification:** Up to this distance, you can determine the identity of an individual beyond reasonable doubt.

DORI Level	Detection		Observation		Recognition		Identification	
	Wide	Tele	Wide	Tele	Wide	Tele	Wide	Tele
Camera								
Mx-VD3A-2-IR-VA	35 m/ 115 ft	109 m/ 358 ft	14 m/ 46 ft	43 m/ 141 ft	7 m/ 23 ft	22 m/ 72 ft	3 m/ 10 ft	11 m/ 36 ft

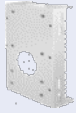

## Accessories

Picture	Order Code	Description
	Mx-M-VD-IC	Ceiling Flush Mount for MOBOTIX MOVE Vandal Dome cameras
	Mx-M-VD-W	Wall Mount set (2 pieces) for MOBOTIX MOVE Vandal Dome cameras
	Mx-M-VD-P	Pole Mount (junction mount) for MOBOTIX MOVE Vandal Dome cameras
	Mx-M-VD-C	Corner Mount for MOBOTIX MOVE Vandal Dome cameras
	Mx-NPA-UPOE1A-60W	UPoE Network Power Injector 60 W
	Mx-A-ETP1A-2601-SET	Media Converter Set Ethernet (PoE+) – Twisted-Pair

---

# Dimensions

**NOTE!** Download the drilling template from the section or on the MOBOTIX website: [www.mobotix.com](http://www.mobotix.com) > [Support](#) > [Download Center](#) > [Marketing & Documentation](#) > [Drilling Templates](#).

**CAUTION!** Always print or copy the drilling template at 100% of the original size!

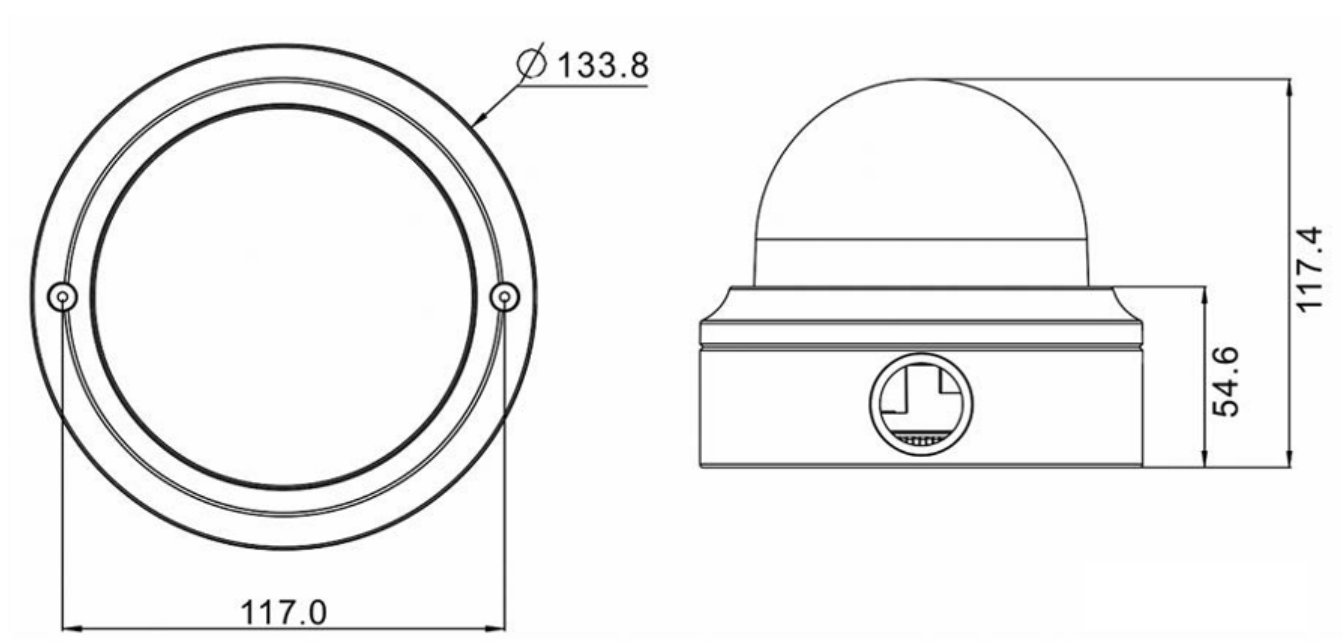

Fig. 1: 2MP Vandal Fixed Dome Analytics Camera: All measurements in mm

## Further Reading

[Manuals and Quick Installation documents](#)



[Video Analytics Manual](#)



[Technical Specifications](#)



[MOBOTIX MOVE Installation Hints](#)



[MOBOTIX Community](#)



# MOBOTIX

BeyondHumanVision

EN\_05/24

MOBOTIX AG • Kaiserstrasse • D-67722 Langmeil • Tel.: +49 6302 9816-103 • sales@mobotix.com • www.mobotix.com

MOBOTIX is a trademark of MOBOTIX AG registered in the European Union, the U.S.A., and in other countries. Subject to change without notice. MOBOTIX do not assume any liability for technical or editorial errors or omissions contained herein. All rights reserved. © MOBOTIX AG 2020