



Technical Specifications

MOBOTIX MOVE 4K (8MP) LIR Video Analytics Speed Dome

Supported by high-performance DNN processor/SoC in combination with state-of-the-art CMOS video sensor, the MOBOTIX MOVE 4K (8MP) LIR Video Analytics Speed Dome is much more than just standard, providing crisp, noise-free and smooth video streaming at high 4K (8MP) resolution even under extreme low-light conditions. The LASER-based object distance measuring LiDAR system ensures precise and fast optical focusing even under difficult environmental and low-light conditions. The integrated DNN-based video analytics functions include face and license plate recognition that can be combined with preset PTZ positions to enable a wide variety of 24/7 video surveillance applications. The MOBOTIX EverClear superhydrophilic and self-cleaning nano coating of the front glass ensures best image quality even in rain and reduces cleaning efforts and operational costs.

- High light sensitivity: 0.02 Lux color, 0.001 Lux B/W
- 31x motorized zoom/focus lens 6.9 to 214.6 mm
- Precise LiDAR focusing system
- WDR up to 130 dB
- Integrated IR illumination up to 300 m/984 ft
- Quad streaming H.264/H.265/MJPEG
- Intelligent encoding, smart low-bitrate control
- MOBOTIX MxMessageSystem
- 2D & 3D motion-compensated noise reduction (MCTF)
- ONVIF Profile S/G/T/M support
- Electronic image stabilizer (EIS)
- Auto object tracking, DNN-based (persons, vehicles)
- DNN video analytics (8 VA, Face & ALPR) linkable to PTZ presets & smart event functions
- Smart Event Functions
- microSD/SDHC/SDXC card support up to 1 TB
- Dual power support (IEEE802.3bt/AC24V)
- Outdoor protection rate IP66, IK10 housing
- Temp. Range -40 to 55 °C/-40 to 131 °F with heater
- EverClear coating of front glass



BeyondHumanVision

MOBOTIX MOVE

Technical Specifications

MOBOTIX MOVE 4K (8MP) LIR Video Analytics Speed Dome

High-Quality DNN Edge Video Analytics



The latest computer vision technology makes the DNN-accelerated video processing engine efficient at the edge. This integrated engine provides high accuracy, real-time object tracking, and 10 (DNN-based) video analytics functions including ALPR and human face recognition. Moreover, it allows simultaneous detection on multiple objects.

MOBOTIX EverClear Nano Coating

The new, groundbreaking MOBOTIX EverClear coating uses a special nano technology that transforms water droplets into an ultra-thin water film immediately upon impact. This ensures the highest image quality in rain and difficult environmental conditions and reduces maintenance costs due to its “self-cleaning” effect.



Product Information

Product Name	4K (8MP) LIR Video Analytics Speed Dome
Order Code	Mx-SD1A-831-LIR-VA

Hardware Design

Processor	Ambarella CV25 (Quad-core ARM® Cortex®-A53, 1 GHz)
Memory	RAM: 512 MBytes FLASH: 256 MBytes
Image Sensor	4K (8MP), 1/2.8" Progressive CMOS IMX678 (SONY STARVIS 2)
Effective (Used) Pixels	3864x2180 (4K/8MP)

Lens

Minimum Illumination	Color: 0.02 Lux B/W: 0.001 Lux F1.6, AGC=on, 30 IRE, 1/1 s
Lens Characteristics	Zoom Lens: Zoom, Auto Focus, P-IRIS, Auto-IRIS Focal Length: 6.9 to 214.6 mm Aperture: F1.35 – F4.6 Horizontal Field of View: 61.8° (Wide), 2.2° (Tele) Vertical Field of View: 35.9° (Wide), 1.3° (Tele)
Focus System	Precise LiDAR-based auto focusing system (905 nm wavelength)
Front Glass Coating	Superhydrophilic MOBOTIX EverClear nano coating transforms water droplets into an ultra-thin water film upon impact. The coating ensures best image quality in rain and difficult external conditions and it reduces reflections and noise in low-light scenarios. EverClear is dirt-repellent and increases the stability as well as the scratch-resistance of the front glass, further reducing maintenance efforts. Coating endurance up to 3 years depending on environmental conditions and cleaning treatment.

Camera

Day/Night	Automatically switchable IR-cut filter
Shutter Speed (Auto)	1 to 1/10000 s
Shutter Speed (Manual)	WDR: 1/67500 s Linear: 1/135000 s

Technical Specifications

MOBOTIX MOVE 4K (8MP) LIR Video Analytics Speed Dome

Shutter Priority Mode	Up to 1/45 s
Frame Rate (maximum)	WDR on/off: H.265/H.264: 4K (8MP)@30 fps MJPEG: 1080p@30 fps
Auto Gain	Min. gain: 3 dB, max. gain: 48 dB, step size: 3
WDR	Up to 130 dB
Electronic Image Stabilizer (EIS)	Yes
Auto Object Tracking	On/off (object-based DNN algorithm: humans/vehicles selectable)
Zoom	Optical: 31x, Digital: 10x
Image Settings	Color, Brightness, Sharpness, Contrast, White Balance, Exposure Control, 2DNR, 3DNR, NR by Motion, Masking, Text Overlay
Image Rotation	90°, 180°, 270°
Servo Feedback	Yes

PTZ Features

Preset positions	Up to 256 positions, 1 Home position
Sequences	Up to 8 sequences with 64 preset positions each
Cruise Paths	Up to 8
Auto Pan Paths	Up to 4
Display Position	Pan/Tilt degrees can be displayed in live image
Pan Range	360° endless
Tilt Range	-20° to +100°
Pan Speed	Manual Pan Speed: 0.1°-90°/s Preset Pan Speed: 300°/s
Tilt Speed	Manual Tilt Speed: 0.1°-55°/s Preset Tilt Speed: 300°/s
Joystick/Keypoint Control	RS485 protocols DSCP, Pelco-D and Pelco-P
Video Analytics	Presets can be combined with 1 selectable integrated video analytics feature

Video Codec

Compression/Encoding	H.265/H.264/MJPEG
Streaming	Up to 4 individually configurable streams in H.264/H.265/MJPEG; configurable resolution, frame rate, bandwidth LBR/VBR/CBR in H.265/H.264.

Audio Codec

Compression/Encoding	G.711/G.726/AAC/LPCM
Streaming	Bi-directional
Audio Input	Line In Max. 2.28 V _{pp} for line signal Input impedance: 33 kΩ
Audio Output	Line Out Output resistance: 220 Ω Output voltage: 1 V _{rms}

Cyber Security Features

Password Protection	Yes (including “forced” password change during initial setup)
IP address filtering	Yes (to restrict unauthorized access based on IP addresses)
IEEE 802.1X network access control	Yes (for advanced network security and authentication)
Digest authentication	Yes (for secure user authentication)
Secure Boot	Yes (support of fixed IP setting and automatic DHCP IP configuration according to individual MAC address)
AES encryption for password protection	Yes (to ensure strong encryption for password storage)
HTTPS/SSL (using TLS)	Yes (TLS 1.2 default, TLS 1.0/1.1 optional selectable)
User and Group Management	Yes (for fine-grained access control)
VPN	Yes (to establish secure network connections)

Technical Specifications

MOBOTIX MOVE 4K (8MP) LIR Video Analytics Speed Dome

Digitally signed firmware	Yes (to prevent firmware file tampering)
RSA encryption	Yes (to support stronger ciphers; supported: RSA (2048 bits), AES-128, AES-256, SHA-256, SHA-384)

Network

Interface	10/100 Mbps Ethernet
Supported Protocols	ARP, PPPoE, IPv4/v6, ICMP, IGMP, QoS, TCP, UDP, DHCP, UPnP, SNMP, SMTP, RTP, RTSP, HTTP, HTTPS, FTP, NTP, DDNS, SMBv2, VPN
ONVIF conformance	Supports profiles S/G/T/M
Supported Browsers	All current browsers are supported.

System Integration

Base Video Analytics	<ul style="list-style-type: none">▪ Motion detection▪ Audio detection
Enhanced Video Analytics (linkable to PTZ presets)	<ul style="list-style-type: none">▪ Abandoned objects▪ Intrusion (object classification)▪ Sabotage▪ Wrong direction▪ Loitering (object classification)▪ Object counting (object classification)▪ Object removal▪ Stopped vehicle (object classification)

2 analytics functions can be activated simultaneously

MOBOTIX MOVE 4K (8MP) LIR Video Analytics Speed Dome

DNN (Deep Neural Network) based video analytics (linkable to PTZ presets)

- Face Recognition (incl. gender & age estimation)
- Number Plate Recognition – supported countries: Armenia, Austria, Azerbaijan, Belarus, Belgium, Bosnia and Herzegovina, Bulgaria, Croatia, Cyprus, Czech Republic, Denmark, Estonia, Finland, France, Georgia, Germany, Greece, Hungary, Ireland, Israel, Italy, Japan, Kazakhstan, Kyrgyzstan, Latvia, Lithuania, Luxembourg, Moldova, Monaco, Montenegro, Netherlands, North Macedonia, Norway, Poland, Portugal, Romania, Russia, Serbia, Slovakia, Slovenia, Spain, Sweden, Switzerland, Taiwan, Turkey, Ukraine, United Kingdom, Uzbekistan, Vietnam

Event Triggers

- External input
- Analytics
- Network failure detection
- Periodical event
- Manual trigger

Event Actions

- External output activation
- Video and audio recording to edge storage
- File upload: FTP, network share and email
- Notification: HTTP, FTP, email

General

Housing Materials Metal and plastic

Housing Color RAL 9003

Power Requirements IEEE802.3bt, Type 3, class 6, max 51.00 watt
AC24V, max 53.10 watt, max 74.80 VA

Connectors

- RJ45
- 4 x Alarm in, 2x Alarm out, Audio in, Audio out, RS485 terminal block
- AC24V terminal block
- CVBS connector (available with max. 2 activated streams)

IR Illumination 850 nm; up to 300 m/984 ft distance depending on scenery reflection

Technical Specifications

MOBOTIX MOVE 4K (8MP) LIR Video Analytics Speed Dome

Video Storage Micro SD/SDHC/SDXC card support up to 1 TB (using SD card adapter),
Support for recording to NAS, MOBOTIX HUB, MOBOTIX MOVE NVR

Remotely Upgradable Yes

Environmental Protection Class IP66/IK10 (housing only)

Operating Temperature -40 to 55 °C/-40 to 131 °F with heater

Relative Humidity 90 % non-condensing

Storage Conditions -20 to 70 °C/-4 to 158 °F

Approvals EMC: CE/FCC
Safety: LVD

MTBF 50,000 hours

Warranty 5 years; mechanically wearable parts (motor, gears, belts, etc.) excluded

Dimensions ø 241 x 364 mm

Weight 5500 g

NOTE! Observe the [MOBOTIX MOVE Installation Hints](#) document to ensure optimum performance of the camera features.

Alarm Input/Output Current and Voltage

Alarm In

5 V with 10 kΩ pull up, 50 mA

Alarm Out

400 V DC/AC, 120 mA









DORI Specifications



In the video surveillance context, “DORI” stands for Detection, Observation, Recognition and Identification and is based on IEC EN62676-4: 2015. These levels define the minimum pixels that a face of a person must have to provide proper identification, for example.

- **Detection:** Up to this distance, you can reliably determine if a person or vehicle is present.
- **Observation:** Up to this distance, you can see characteristic details of an individual, such as distinctive clothing.
- **Recognition:** Up to this distance, you can determine with a high degree of certainty whether an individual is the same as someone that has been seen before.
- **Identification:** Up to this distance, you can determine the identity of an individual beyond reasonable doubt.

DORI Level	Detection		Observation		Recognition		Identification	
	Wide	Tele	Wide	Tele	Wide	Tele	Wide	Tele
Camera								
Mx-SD1A-831-LIR-VA	139 m/ 465 ft	3843 m/ 12608 ft	55 m/ 180 ft	1525 m/ 5003 ft	28 m/ 92 ft	767 m/ 2516 ft	14 m/ 46 ft	384 m/ 1260 ft

Accessories

Picture	Order Code	Description
	Mx-M-SD-C	Corner Mount
	Mx-M-SD-GN	Parapet Mount (Gooseneck) with integrated junction box
	Mx-M-SD-P	Pole Mount
	Mx-M-SD-PM	Pendant Mount Kit 25 cm
	Mx-M-SD-PMEXT	Pendant mount extension 25 cm for use with Pendant Mount Kit Mx-M-SD-PM
	Mx-M-SD-W	Wall Mount; can be combined with Pole Mount Mx-M-SD-P or Corner Mount Mx-M-SD-C
	Mx-M-SD-WM	Wall Mount with room for optional junction box
	Mx-M-SD-WMJB	Wall Mount Junction Box

Picture	Order Code	Description
	Mx-NPA-PoE1A-60W-BT	Network Power Injector 60 W
	Mx-A-ETP1A-2601-SET	Media Converter Set Ethernet (PoE+) – Twisted-Pair

Dimensions

NOTE! Download the drilling template from the section or on the MOBOTIX website: www.mobotix.com > [Support](#) > [Download Center](#) > [Marketing & Documentation](#) > [Drilling Templates](#).

CAUTION! Always print or copy the drilling template at 100% of the original size!

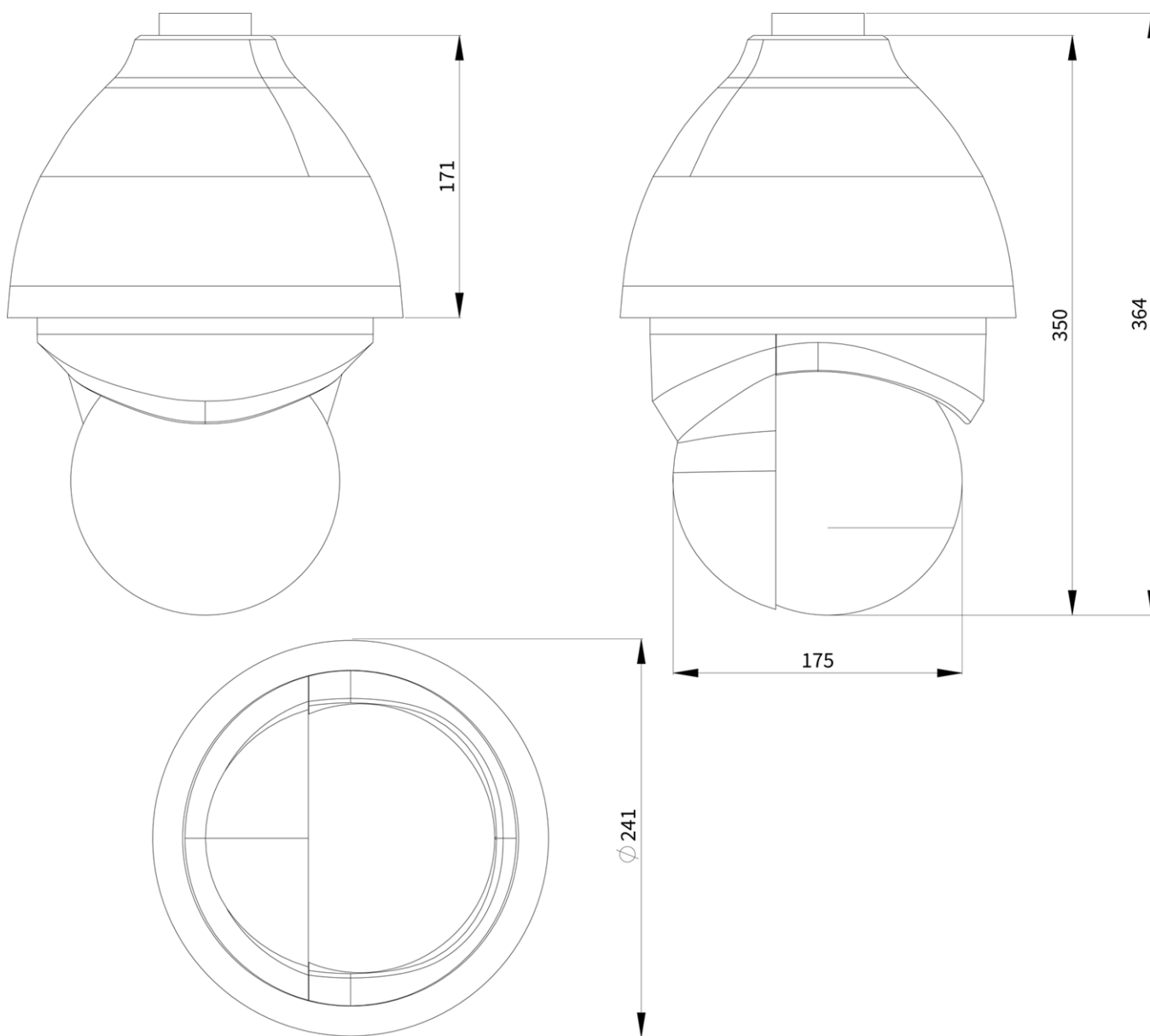

Fig. 1: 4K (8MP) LIR Video Analytics Speed Dome: All measurements in mm

Further Reading

[Manuals and Quick Installation documents](#)



[Video Analytics Manual](#)



[Technical Specifications](#)



[MOBOTIX MOVE Installation Hints](#)



[MOBOTIX Community](#)



MOBOTIX

BeyondHumanVision

EN_05/24

MOBOTIX AG • Kaiserstrasse • D-67722 Langmeil • Tel.: +49 6302 9816-103 • sales@mobotix.com • www.mobotix.com

MOBOTIX is a trademark of MOBOTIX AG registered in the European Union, the U.S.A., and in other countries. Subject to change without notice. MOBOTIX do not assume any liability for technical or editorial errors or omissions contained herein. All rights reserved. © MOBOTIX AG 2021